

Asset Management Plan 2006 - 2016



August 2006

Summary of ENL's AMP

Purpose of the AMP

This Asset Management Plan ("AMP") has been prepared to meet regulatory compliance requirements, demonstrate responsible asset stewardship, integrate stakeholder views, and communicate and justify network management practice and expenditure to Eastland Network Limited ("ENL") stakeholders. Presentation of the AMP in this format also meets the requirements of Section 24 and Schedule 2 of the Electricity Information Disclosure Requirements issued 31 March 2004 consolidating all amendments to 1 April 2006.

Primary stakeholders include ENL's shareholder and customers, including retailers, generators and end-use electricity consumers. Other parties with an interest in ENL's asset management include contractors who physically work on the system and regulatory agencies.

Many factors impact on the effective long term management of a complex network of electricity assets, the life of which exceeds the tenure of the Managers responsible for them and whose operating environment introduces significant investment risks. For this reason, the overall scope of the AMP is wide, covering likely changes in the regulatory environment, future service demands and technology development.

While making long term projections to provide sustainability and establish the framework for ENL's future, the AMP primarily drives work programmes in the short to medium term. It is in all respects a living document. The practices and processes described are subject to continuous improvement, and detailed work programmes are progressively refined throughout the year. The Eastland Infrastructure Limited ("EIL") asset management team is the "owner" of this AMP.

Completion date & planning period

Preparation of the AMP was undertaken between May and mid August 2006. The ten year planning period considered is from 01 April 2006 to 31 March 2016. The plan documents how ENL ensures long lived network assets are being managed in a sustainable way over their lifecycle within defined boundaries of Shareholder returns, Regulatory requirements for performance and revenues, Customer expectations and Regulatory requirements for Safety and Quality.

The ENL Board of Directors approved the AMP for disclosure on 30 August 2006.

The next revision of the AMP, (covering the period 2007 to 2017) will be prepared for disclosure on 31 August 2007.

AM systems & information

ENL uses a variety of information systems to store information on its assets, their condition and performance. The majority of the asset attribute and maintenance information is stored in databases associated with the GIS system. Stand alone systems provide work management and core financial management capabilities.

The SCADA system provides real time data and enables remote control of key components of the network. This data and network modeling software is used to analyse the network and the impact of changes in utilisation and operation.

The asset management process prioritises the programs for maintenance and asset development to ensure optimum customer service and operational efficiency within financial boundaries. This includes the recognition of the needs of large customers who are willing to pay to have additional security and/or reliability of supply. Implicit in the asset planning process is an understanding and evaluation of the risks to operation and the consequences of failure. ENL is continually striving to find more efficient ways to carry out its activities, reducing costs and improving productivity.

The systemized processes that form the core of asset management practice and decision making at ENL are condition assessment, reliability performance analysis, asset utilisation/capacity evaluation, risk management, economic optimisation, and benchmarking.

Management services only are provided by EIL to ENL. This includes fulfilling ENL's financial management, planning, design and network operating activities. Since all physical work on the network is contracted out, the network operating function includes significant responsibility for contractor management. In addition to applying commercial disciplines to project identification and justification, ENL negotiates competitive contracts for maintenance and capital projects. The need to train and continuously upgrade the skills of internal staff is recognised through improvement programmes and specific training. In the case of contractors and suppliers, forward-looking commercial agreements encourage a partnering approach to skills development and productivity improvement.

Asset description

The distribution network assets included within the scope of the AMP are indicated below together with quantities and the current replacement cost valuation. Note the valuation figures are based on the ODV as at 31 March 2004.

Asset description	Quantity	Unit	Average age	Condition summary	ODRC	Percent of ODRC
Subtransmission line	327	km	27.8	Average	2470	2.86
Subtransmission Poles	2441	each	25	Average	4763	5.52
Subtransmission cable	2	km	1	Good	11	0.01
Other zone substation assets		total	6.4	New/good condition	4642	5.38
50/11kV and 33/11kV transformers	23	each		Average	2799	3.24
Distribution line	2453	Km	35	Condition Ageing	8786	10.18
Distribution Poles	26856	each	26	Condition Ageing	16404	19.01
Distribution cable	121	km	21	Above Average	8212	9.52
Voltage regulators	9	each		Average	299	0.35
Distribution Substations	3583	each	24	Average	2376	2.75
Distribution transformers	3509	each	24	Average	8831	10.23
Distribution Fuses	2856	each	26	Below Average	2032	2.35
Distribution switchgear	1820	each	21	Above Average	7747	8.98
LV lines	538	Km	35.4	Ageing	4011	4.65
LV Poles	9455	each	28	Ageing	3559	4.12
LV cable	187	km	25	Average	6455	7.48
Communications		total	3.7	Technology determines Condition	420	0.49
SCADA & system control		total	2.5	Technology determines Condition	679	0.79
Connection assets	24876	each	23	Customer Drives upgrades	1803	2.09
Total			22		86299	

Like most network infrastructure, ENLs distribution assets are dispersed over a large area and are highly interdependent. Although the service

area includes Gisborne city and Wairoa township, the existing network is predominantly rural in character. It is also the cumulative result of almost 80 years investment and development.

The average age of the distribution network at the beginning of the planning period is estimated to be 23 years. This is expected to increase over the planning period with the estimated average age in 2015/16 being 30 years.

Service levels

The overall objective of asset management is to ensure the most efficient and optimum investment in assets to provide desired service delivery. Performance targets are established by considering a wide range of business and asset management drivers, some directly influenced by stakeholders, others a result of the historical pattern of development of ENL's network. ENL has surveyed customers and their representative groups in various market segments and considers their views and willingness to pay when making base investment decisions.

A backlog in network renewal existed at the start of the 2000/01 planning period, which evidenced itself in an aging network and poor reliability and safety performance. Between 2000 and 2004 significant network condition issues were corrected, providing a network configuration and capacity that is sufficient to meet current regulatory service targets. While ultimately it is customer requirements and financial commitments that drive work programmes, the AMP forecasts near steady state service levels for the planning period as investment to improve service beyond regulated levels is seen as over investment and as such cannot be justified.

In the longer term, (beyond 5 years), steady state reliability performance and regulatory performance targets may not be achieved because of constraints on ENL's ability to invest in the network due to regulatory revenue control. The shortfall in renewal investment versus required renewal rates will result in the average age of the network increasing and a backlog of asset renewal occurring. Issues regarding levels of achievable network investment and the affect on operational performance are being continually reviewed and will be updated as appropriate in future versions of the AMP.

ENL describes levels of service delivery and efficiency using well recognised and disclosed industry performance measures. The method for calculation of the measures is in accordance with prescribed rules. The most significant reliability measure is the System Average Interruption Duration Index ("SAIDI"), which indicates network performance in terms of the interruptions experienced by customers.

Key reliability and efficiency performance targets for the next 10 years are indicated:

PERFORMANCE MEASURE	2005/06 Actual (subject to audit)	2006/07	2007/08	2008/9	2009/10	2010/11	2011 - 2016
SAIDI : B Planned	27.50	43	43	43	43	43	43
SAIDI : C Unplanned	321.86	242	242	242	242	242	242
DIRECT COST \$/km	675	675	675	675	675	675	675
INDIRECT COST \$/connection	70	70	70	70	70	70	70

It should be noted that external influences such as severe weather events and foreign interference can dramatically impact upon reliability statistics and year-to-year variances can be large. Also extrapolation limits the probability of achievement the further projections are extended. Therefore ENL sets medium term targets as the drivers to achieve and monitor performance while long term targets are used to indicate desired trends.

ENL's overriding objective in setting service levels is to deliver customer value by matching the performance of its assets and all asset activities to the performance customers expect and are willing to pay for, and the returns on investment required by the shareholder. Targets also reflect the requirement on ENL to maintain compliance with Quality Thresholds 6(1) (a) and 6(1) (b), forming part of the Targeted Control Regime for Electricity Lines Businesses. The targets established above reflect average performance within a benchmark group of utilities of similar size, customer density, urban/rural split, and transmission remoteness.

Maintenance expenditure is the dominant component of the disclosed direct cost efficiency measure. ENL has achieved a lower than average industry level of direct cost expenditure which is forecast to be maintained over the planning period.

The level of indirect expenditure achieved by ENL equates to the industry average and is forecast to be maintained over the planning period.

Lifecycle & development plans

ENL has experienced several years of moderate to high base load growth and expects this to continue. However growth is uncertain and is driven by the regions economic outlook, and in the longer term, by changes in

technology and other factors. Growth is particularly sensitive to the pattern of development of the regions forestry resources, gas resources and industry. New technology and the use of distributed generation represent very real opportunities for ENL to reduce the need for transmission and distribution network upgrades.

Facing the challenges associated with serving a consumer base that is very different to what was historically planned for, ENL uses a variety of load forecasting techniques to help predict the impact of accumulated load growth on its capacity requirements and security standards. Coincident system peak demand has been forecast to grow from 56 MW in 2006 to 71 MW in the horizon year, 2016. Predictions use an optimistic/worst case model to ensure timely planning. This base forecast includes foreseeable industrial developments. Specific triggers have been identified for major upgrades to ensure efficient investment to meet security standards and avoid capacity constraints.

Life cycle management plans outline exactly what is planned to manage and operate the assets at the target levels of service while optimizing lifecycle costs. An assets life cycle starts with planning its necessity, continuing through design, investment, operation and maintenance, and concluding with replacement and/or disposal. Life cycle asset management encompasses the policies and practices applied during all phases of an assets life to ensure the sustainable delivery of a power supply in the most efficient manner.

ENL uses load flow analysis to assist in identifying solutions to network issues such as security, power quality and uneconomic supplies. Alternative scenarios and options are modeled to optimize development plans, while the timing of work is largely determined by expected load growth.

Detailed life cycle management plans are prepared by asset and expenditure category. Capital plans present background data and plans for renewal, replacement, augmentation and non-asset solutions in response to asset aging, growth, reliability, performance, compliance and quality. Maintenance plans detail the regular on-going work that is necessary to keep assets operating, including the basis for condition monitoring, equipment standards, planned maintenance and provisions for unplanned actions in response to faults or incidents. ENL drives maintenance work based on condition and reliability assessments, as opposed to planned maintenance based on time usage of an asset.

Since ENLs assets are in the age replacement phase of their life cycle, the management tactic focuses on replacement over heavy maintenance. The

average age is forecast to increase as existing population profiles for conductor and poles in particular show the predominant installation period is nearing end of expected life while renewal rates have been minimized to balance renewal costs with allowable regulated revenues and return on asset value requirements.

Risk assessment

Effective risk management is required to protect the long-term viability of ENL and to protect its stakeholders. ENL uses a systematic outcome-based method for assessing asset related risks. This focuses on identifying and prioritizing mitigating actions, which are subsequently captured in work programmes and network development plans.

Financial Summary

Total capital expenditure over the planning period is \$50.185 m. The expenditure profile is relatively flat with an average expenditure of approximately \$5.0 m pa, indicating steady state assumptions apply. This level of capital expenditure equates to approximately 6.0% ODV which based on the 2005 Information Disclosure statistics is in line with the industry average of 6.2%.

Capital expenditure forecasts for the planning period are provided by asset type and expenditure "driver". Comments on the categories of expenditure "driver" are made below.

Condition and compliance driven asset renewal capital expenditure for the planning period averages \$3.5m pa., and is \$36.58m in total. It equates to 70% of the total capital expenditure forecast for the period. Condition and Compliance expenditure is fully funded by depreciation. Primarily as a consequence of regulatory revenue constraint, an approximate \$1.0m pa. difference is forecast between achievable renewal investment and the level of investment required to address asset renewal rates.

Growth and security driven capital expenditure for the planning period is \$9.99m and is 20% of the total capital expenditure forecast for the planning period.

A key feature of these projections is that while the AMP attempts to predict the impact of growth on network development, probable

timings, etc. these issues are excluded from financial planning until more certainty on size and location and optimum response is evident.

Performance and new development driven capital expenditure for the planning period is \$5.35m and equates to 10% of the total capital expenditure forecast for the period.

Total maintenance expenditure over the planning period, as described in Section 5.3, is \$17.932 m which equates to an average expenditure of \$1.79m p.a. The expenditure profile is relatively flat indicating steady state assumptions apply.

Performance & improvement plans

Improvement is the primary responsibility of the asset management team and is continuous as the AMP is updated during the normal business planning cycle. Internal and external audits are undertaken at regular intervals and are directed at: confirmation of the validity of technical content, assessment of asset management performance against best practice, and identification and implementation of asset management practice improvements.

ENL reviews the benchmarking of asset management practices in order to more effectively target improvements. Performance measures have been developed to ensure that meaningful comparisons with comparable lines companies can be undertaken and compliance with regulatory targets is maintained.

Ongoing asset management improvement initiatives target increased capture of detailed asset attribute and performance information which facilitates the development of capital and maintenance plans to correct condition and asset deficiencies and meet growth requirements.

The primary indicator of reliability performance is the SAIDI index

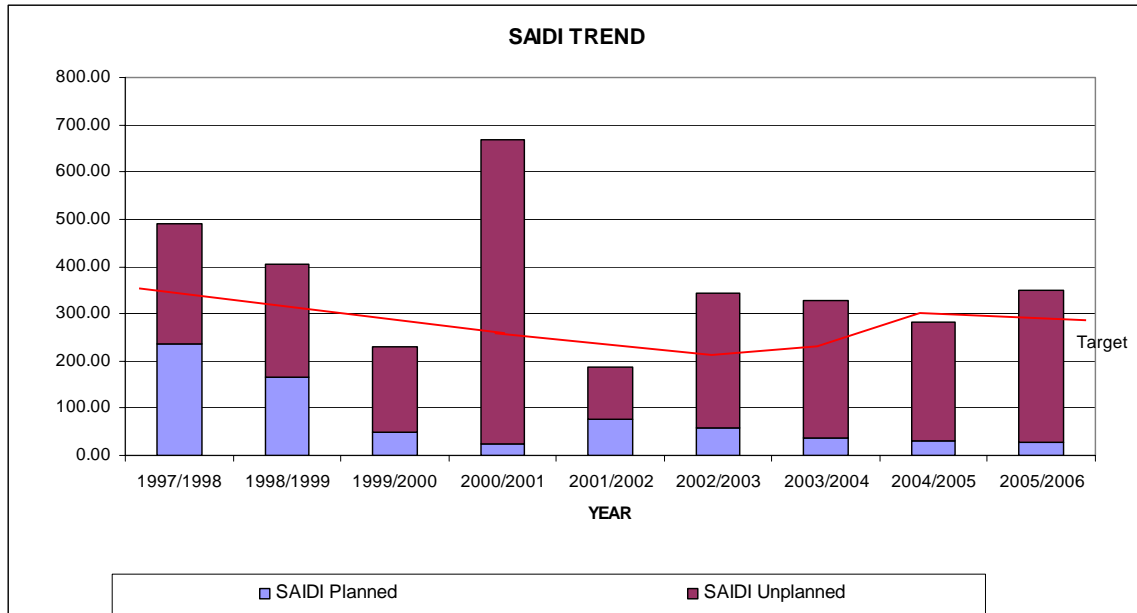

Installation of remote diesel generators between 2002 and 2003 has reduced the impact of planned outages. The extent of this reduction cannot be seen in the statistics as pole replacement on spur 50kV lines, previously deferred, was undertaken between 2003 and 2005 without any impact on outage statistics.

Significant weather events and environmental factors such as slips after long periods of rainfall, generally considered as normal, have the most significant impact on ENL's ability to achieve its targets. The low proportion of planned to unplanned makes it difficult to control to targets by manipulation of planned work.

Asset Condition has been identified as having a gap in terms of currently targeted renewal quantities verses forecast expectations of asset failure for some asset categories. The installation profile of the overall asset and historical practices has provided a 'bow wave' effect where at some point the steady state approach for asset renewal adopted by ENL to manage expenditure in line with the current regulated revenue regime will not keep up with the asset deterioration. In the long term this will have an effect on network performance.

With a decline in available field service contracting resources becoming apparent in New Zealand and more significant in the local region, ENL is actively contributing to training and development of new resource at the entry level to ensure improvement of its asset management activities in the long term.

ENL has a technology focus and is active in identification and development of equipment and systems designed to offset the effects of renewal investment and resourcing short falls.

Membership, strategic partnership and alliances are being developed in the short to medium term to improve ENL's understanding and input into the direction of the industry.

Contents

Summary of ENL's AMP.....	2
<u>Purpose of the AMP</u>	2
<u>Completion date & planning period</u>	2
<u>AM systems & information</u>	3
<u>Asset description</u>	3
<u>Service levels</u>	5
<u>Lifecycle & development plans</u>	6
<u>Risk assessment</u>	8
<u>Financial Summary</u>	8
<u>Performance & improvement plans</u>	9
Contents.....	12
1. <u>Background & objectives</u>	14
1.1 <u>Purpose of this AMP</u>	14
1.2 <u>Interaction with other goals & drivers</u>	14
1.3 <u>Period covered by this AMP</u>	19
1.4 <u>Stakeholder interests</u>	19
1.5 <u>Accountabilities for asset management</u>	22
1.6 <u>ENL's processes & systems</u>	25
1.6.2 <u>Asset Management Systems</u>	27
2. <u>Details of ENL's assets</u>	30
2.1 <u>ENL's distribution area</u>	30
2.2 <u>ENL's network configuration</u>	34
2.3 <u>Age & condition of assets by category</u>	69
2.4 <u>Justification for assets</u>	95
3. <u>Service levels</u>	97
3.1 <u>Consumer-oriented service levels</u>	97
3.2 <u>Industry and Business performance targets</u>	104
3.3 <u>Justification of service levels</u>	107
4. <u>Development plans</u>	109
4.1 <u>Planning approach & criteria</u>	109
4.3 <u>Demand forecast</u>	124
4.4 <u>Where are the capacity constraints</u>	143
4.5 <u>Use of non-asset solutions</u>	146
4.6 <u>Policies for distributed generation</u>	146
4.7 <u>Development program</u>	148
5. <u>Managing the assets lifecycle</u>	178
5.1 <u>What is the lifecycle of an asset</u>	178
5.2 <u>Operating the assets</u>	180
5.3 <u>Maintaining the assets</u>	182
5.4 <u>Renewing assets</u>	204

5.5	<u>Up-sizing or extending the assets</u>	217
5.6	<u>Retiring of assets</u>	231
6.	<u>Managing the risks to the business</u>	232
6.1	<u>Understanding the business risk profile</u>	232
6.2	<u>Identifying specific risks</u>	242
6.3	<u>Planned responses</u>	246
7.	<u>Funding the business</u>	250
7.1	<u>ENL's business model</u>	250
7.2	<u>Financial Income</u>	250
7.3	<u>Financial Projections</u>	253
7.4	<u>How is the asset value changing</u>	268
7.5	<u>Depreciation and Renewal of the assets</u>	269
8.	<u>Performance & improvement</u>	271
8.1	<u>Performance against financial plans</u>	271
8.2	<u>Meeting performance targets</u>	274
8.3	<u>Meeting Delivery Efficiency targets</u>	277
8.3	<u>Areas for Improvement</u>	278
8.4	<u>Improvement Implementation</u>	279
A1.	<u>Feeder loadings</u>	280
A2.	<u>Director certification</u>	305

1. Background & objectives

1.1 Purpose of this AMP

The purpose of this AMP is to provide a management framework that ensures that ENL...

- Sets service levels for the electricity network that will meet owner, consumer, community and regulatory requirements.
- Understands what network capacity, reliability and security will be required both now and in the future, and what issues drive these requirements.
- Has a robust and transparent process in place for managing all stages of the network asset life cycle from conception to removal.
- Has adequately considered the classes of risk the network business faces, and has systematic processes in place to mitigate identified risks.
- Has made provision for funding phases of the network asset lifecycle while balancing levels of investment against allowable regulated revenue and return on asset value requirements.
- Makes decisions within systematic and structured frameworks at each level within the business, and that it especially doesn't make ad-hoc decisions.
- Has an ever-increasing knowledge of discrete asset components including locations, ages, conditions, performance and likely future behavior as components deteriorate, age and are required to perform at different levels.

Disclosure of the AMP in this format will also fulfill the requirements of Section 24 and Schedule 2 of the Electricity Information Disclosure Requirements 2004 and subsequent amendments up to 1 April 2006

1.2 Interaction with other goals & drivers

All of ENL's assets exist within a strategic context that is shaped by a wide range of issues including ENL's Statement of Purpose and Vision,

the prevailing regulatory environment, government policy objectives, commercial and competitive pressures and technology trends. ENL's assets are also influenced by technical regulations, asset deterioration, the laws of physics and risk exposures independently of the strategic context, and indeed these issues may constrain the strategic plan.

1.2.1 Corporate purpose & vision

Because ENL is owned by a community trust, ENL's management has a strong focus on community-based objectives. ENL's statements of purpose and vision therefore communicate a strong focus on the development of the local economy.

STATEMENT OF PURPOSE

Eastland Network will utilise existing assets to achieve an appropriate return for the shareholder while providing opportunities for business growth and improving the value delivered to customers.

VISION

Eastland Network will provide returns on assets, growth on investments and operating performance which places it in an average position relative to other New Zealand electricity companies with similar geographic, demographic and loading and fixed asset investment characteristics.

Safe, reliable and optimally-priced delivery of electricity influences the competitiveness of local wealth creating businesses. If they don't create long-term sustainable wealth ENL loses out as well.

1.2.2 Vision for asset management

ENL's vision for asset management is...

VISION FOR ASSET MANAGEMENT

Eastland Network's asset management function will strive to optimise its' investment in electricity distribution and generation assets to provide levels of service that are acceptable to its customers and other stakeholders at a price that maximises economic efficiencies.

The key aspect of implementing this vision is through having well defined and robust processes for optimizing spend levels at all stages of asset lifecycles. These processes are discussed in Section 1.6 of this AMP.

1.2.3 Overview of asset management process

ENL's core planning document is the Strategic Plan which considers all the strategic drivers depicted in figure 1.2.3(a). The Strategic Plan regularly examines these issues at intervals appropriate to how fast each issue moves, and identifies the few important things ENL must focus on to fulfill its Statement of Purpose and its Vision. A key influencer of ENL's Strategic Plan is the increasing level of regulation that the lines sector faces – not only are ENL's prices and supply quality regulated, but many of ENL's activities such as the preparation of this AMP and disclosure of performance indices are heavily prescribed.

The relationship of the AMP to the Strategic Plan needs to consider the following issues;

- The physical degradation of ENL's assets due to corrosion and operating characteristics is largely independent of ENL's chosen business strategy (notwithstanding decisions to spend on the assets) and of the regulatory framework.
- The nature and configuration of ENL's assets reflects past business strategies and policy environments more strongly than present strategies, e.g. past rural electrification has resulted in segments of network considered uneconomic in the current environment.

The preparation of the AMP proceeds in parallel with the preparation of the Strategic Plan and is shaped by it rather than being absolutely dependent on it.

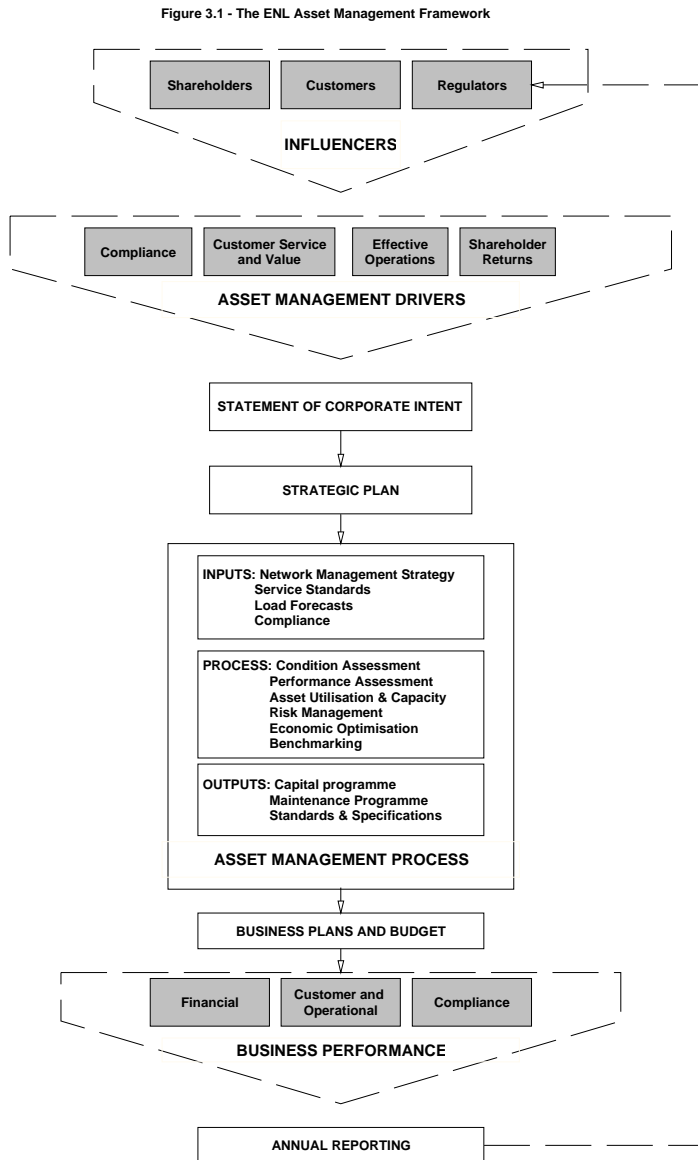

1.2.4 Interaction of key planning documents

Interactions of the key planning documents are as follows...

- Statement of Corporate Intent. This document defines the Director’s intentions and objectives for ENL for the next three financial years and is agreed with the owners. This encompasses planned business

activities and objectives, values, performance targets and communication methods.

- Strategic and Business Plans. Annual plans and key initiatives are established to support the achievement of performance targets. Because the AMP is a tactical plan and a repository for detailed asset information, these documents are closely coordinated during the business planning cycle.
- Ten Year Financial Plan. The Ten Year Financial Plan identifies funding requirements necessary to achieve the capital and maintenance budgets as produced by the AMP, and any other business funding requirements. The Financial Plan identifies funding constraints that may affect the ability to achieve AMP objectives thereby influencing changes to the AMP and/or demonstrates that business performance and service objectives can be met.
- Customer Relationship Management Plans. These plans record consultations with major electricity users regarding their current and future electricity supply requirements and their preferences for price and quality trade-offs. ENL also seeks to determine the needs of all electricity users from the Energy Retailers that represent them. The Energy Retailers have contractual arrangements with ENL that incorporate the desired requirements for energy delivery services to their customers. ENL focuses on the wealth-creating sector of the local economy and also consults with a number of other representative community groups such as Federated Farmers and Grey-Power as proxies for the mass-market.

The outputs from the asset management process are the operational, maintenance and capital work programs...

- Operational Activities. The operational triggers and activities are described in Section 5.2.
- Maintenance Plans. The trigger points and activities for maintaining the assets are presented Section 5.3.

- Capital Replacement Plans. Analysis of asset performance age and condition result in optimal asset renewal programs presented in Section 5.4.
- Development Plans. Analysis is undertaken to test growth and performance against service standards. A Network Development plan is then created in line with investment and risk policies. This is summarised in section 4.7.
- Equipment and Design Standards. Detailed equipment and design specifications, based on the required functionality of the assets, are included in the Network Quality System. General standards and issues concerning quality and compliance are covered in the lifecycle management sections of this AMP.

1.3 Period covered by this AMP

This edition of ENL's AMP covers the 10 year period 1 April 2006 to 31 March 2016.

This AMP was prepared over the period May to mid August 2006 by EIL's General Manager Electricity Operations and Asset and Planning Manager. Assistance was provided by an external consultant, Utility Consultants.

The AMP was approved by the ENL Board of Directors on 30 August 2006 and publicly disclosed in accordance with clause 4.1.4 of the Electricity Information Disclosure Handbook Amendment 2006.Handbook, on 31 August 2006.

1.4 Stakeholder interests

1.4.1 Stakeholder identification

ENL defines its stakeholders as any person or class of persons that does or may do one or more of the following...

- Has a financial interest in ENL (be it equity or debt).
- Be physically connected to ENL's network.
- Use ENL's network for conveying electricity.
- Supply ENL with goods or services.
- Be affected by the existence, nature or condition of ENL's network.

- Have a statutory obligation to perform an activity in relation to the existence of ENL's network (such as request disclosure data or regulate prices).

1.4.2 Stakeholder interests

The interests of ENL's stakeholders are defined in Table 1.4.2(a) below...

Table 1.4.2(a) – Key stakeholder interests

	Interests			
	Viability	Supply quality	Safety	Compliance
Shareholder	✓		✓	✓
Bankers	✓			
Connected customers	✓	✓	✓	
Energy retailers	✓	✓		
Mass-market representative groups	✓	✓		
Industry representative groups	✓	✓		
Staff & contractors	✓		✓	✓
Public			✓	
Councils (excluding as a consumer)			✓	
Land Transport			✓	✓
Ministry of economic development			✓	✓
Commerce Commission		✓		✓
Electricity Commission				✓

1.4.3 Accommodating stakeholder interests

Table 1.4.2(a) provides a broad indication of how ENL accommodates stakeholder interests...

Interest	Description	Accommodating that interest
Viability	Viability is necessary to ensure that ENL's shareholder and providers of finance have sufficient confidence to retain ownership of ENL or provide finance to ENL.	<ul style="list-style-type: none"> • ENL accommodates its stakeholders' needs for long-term viability by delivering earnings that are sustainable and reflect an appropriate risk-adjusted return on employed capital
Supply quality	Emphasis on continuity, restoration is essential to minimizing interruptions to ENL's customers businesses.	<ul style="list-style-type: none"> • ENL accommodates stakeholders' needs for supply quality by focusing resources on continuity, provision of security and restoration which is what ENL's customers have said is important to them.

Safety	ENL's staff, contractors and the public at large must be able to live in close proximity to network assets and/or work on the network in total safety.	<ul style="list-style-type: none"> • ENL ensures that the public at large are kept safe by managing the network assets so that they are installed, operated and maintained to relevant regulations, codes of practice and standards relating to their structural strength, electrical safety and design functionality. • ENL ensures the safety of its staff and contractors through implementation of its Health & Safety Management System which prescribes the process and procedures for hazard identification/management, contractor management/auditing, staff/contractor training & competency assessment, the provision of safety equipment and safe work procedures.
Compliance	ENL has a duty to comply with many statutory requirements ranging from safety to disclosing information and targeted threshold regimes for price, quality and customer consultation.	<ul style="list-style-type: none"> • ENL ensures that all safety issues are adequately documented and available for inspection by authorised agencies. • ENL discloses performance information in a timely and compliant fashion. • ENL will restrain its net prices to within the limits prescribed by the price path threshold.

1.4.4 Managing conflicting interests

ENL's priorities for managing conflicting stakeholder interests are...

- Safety. ENL will give top priority to safety. Even if ENL has to exceed budget, the safety of staff, contractors or the public, (and their property) are a primary consideration.
- Viability. ENL will give second priority to sustainable financial viability because without it the business will cease to exist which makes supply quality and compliance pointless.
- Supply quality. ENL will give third priority to supply continuity and quality as this is what makes energy users, and therefore ENL, successful.
- Compliance. ENL has a duty to comply with all the regulatory requirements applicable to lines businesses and endeavors to meet those requirements. However ENL also understands that achieving compliance may on occasion be in tension with other interests such as financial viability. Under these circumstances ENL will decide a course of action that is sustainable and reflects a balanced view of all stakeholder wishes and expectations.

To achieve consistency regarding the management of conflicting stakeholder interests, the priority structure above is considered and applied during ENL's annual Strategic and Business planning cycles. The outcome is that the annual Business Plan provides at an operational level direction and detail on how prioritized objectives set out in the Strategic Plan will be realized and associated performance measured.

1.5 Accountabilities for asset management

The ownership and governance structure of Eastland Infrastructure Ltd is depicted below...

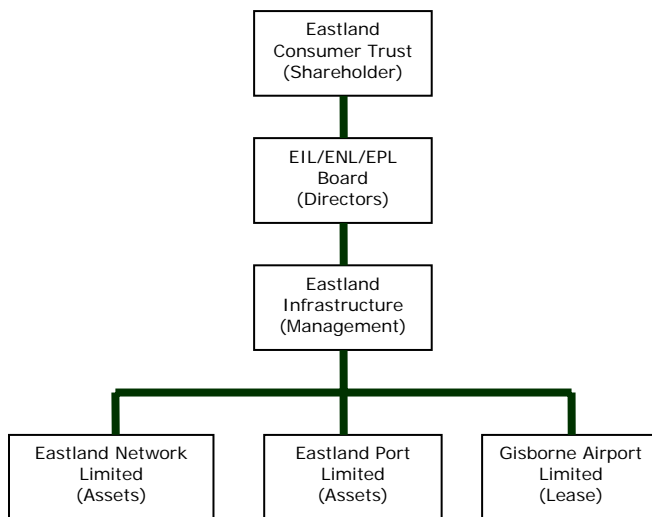

The Eastland Consumer Trust wholly owns Eastland Infrastructure Ltd, the electricity assets of Eastland Network Ltd (ENL) and the port assets of Eastland Port Ltd (EPL). Eastland Infrastructure Ltd is a management only company which provides via performance contracts, management, operational and support services to Eastland Network Ltd (ENL), Eastland Port Ltd (EPL) and the leased assets of Eastland Airport (EA). ENL, EPL and EA are entities that contain assets only and do not employ directly any staffing resources.

With respect to the management of ENL distribution network assets, EIL provides the services and resources required to carry out all financial management, planning, design and network operating activities. Since all physical installation and maintenance work carried

out on network assets is contracted out, the network operating function includes significant responsibility for the management of accredited independent contractors.

Contractors tender for packages of maintenance activity and/or capital works projects. Contracts are awarded on the evaluated performance criteria of price, quality/safety and timeliness. Contract tendering and management is carried out in accordance with NZS 3910:1998 "Conditions of Contract for Building & Civil Engineering Construction".

ENL believes that competitive tendering is beneficial for the business as it stimulates contractor innovation and results in field services being provided at the true market rate. As such ENL does not operate a system of preferred contractors. Any contractor is able to tender for ENL work provided that they are able to meet and maintain predetermined standards relating to demonstrating competency, the provision of quality, health & safety and financial management systems.

1.5.1 Accountability at governance level

Governance of EIL is provided by a Board of Directors appointed by the Eastland Consumer Trust.

The inclusion of SAIDI, SAIFI and CAIDI targets and Direct and Indirect cost targets in the Statement of Corporate Intent makes ENL's Board intimately accountable to the shareholder for these important asset management outcomes. The inclusion of revenue and financial performance targets in the statement makes the Board additionally accountable for overseeing the price-quality tradeoff inherent in projecting revenue and network performance.

The requirement for the Strategic Plan, the Business Plan, (including capital and maintenance expenditure budgets), and the AMP to be approved by the Board of Directors adds a further accountability function. On a monthly basis the Board receives updates on progress against service level and financial performance targets. Performance against Statement of Corporate Intent targets is reported regularly to the Shareholder.

1.5.2 Accountability at executive level

Overall accountability to the ENL Board of Directors for the performance of the electricity network, the port and the airport rests with EIL's Chief Executive whose employment contract specifies *inter*

alia the asset management outcomes to be created such as safety, reliability, revenue, profitability and compliance.

1.5.3 Accountability at operational level

The General Manager Electricity Operations is accountable to the Chief Executive for the safe, reliable, profitable and compliant operation of the electricity network principally through his employment contract. Accountabilities of the GM-Elect Ops include overall responsibility for achieving compliance with all EIL corporate policies and procedures, (including planning/reporting, human resource management, health & safety management, environmental management, contract tendering management, regulatory disclosure management and financial/budgetary management).

Below the GM–Elect Ops activities, accountabilities, resources and responsibilities for achieving EIL corporate policies and procedures are assigned as follows...

- The long term planning function which undertakes asset planning and design work and includes the company's professional engineering resources and the drawing/information record keeping. Production of this AMP, (including annual capital and maintenance expenditure budgets) is a key accountability of the Asset and Planning Manager who reports to the GM-Elect Ops.
- The short term operations function implements work programs, operates the network, and manages contractors. Delivery of reliability, budget cost, and safety performance are the key accountabilities of this group who on an individual basis are assigned responsibility for the implementation of specific capital and/or maintenance activities and budgets as determined in the AMP. Contract and operation reviews provide additional feedback from contractors.

Close interaction between Planning and Operations is achieved through the stewardship of the GM–Elect Ops. Group responsibility for operation of the control room and the achievement of network reliability, budgetary, safety and environmental performance targets also fosters close interaction between the Planning and the Operations people.

1.6 ENL's processes & systems

The core of ENL's asset management activities lie with the detailed processes and systems that reflect ENL's thinking, manifest in its policies, strategies and processes and ultimately shapes the nature and configuration of its fixed assets. The hierarchy of data model shown in Figure 8(a) describes the typical sorts of information residing within the business which includes that held by employees by virtue of their skills and experience.

Figure 8(a) – Hierarchy of data

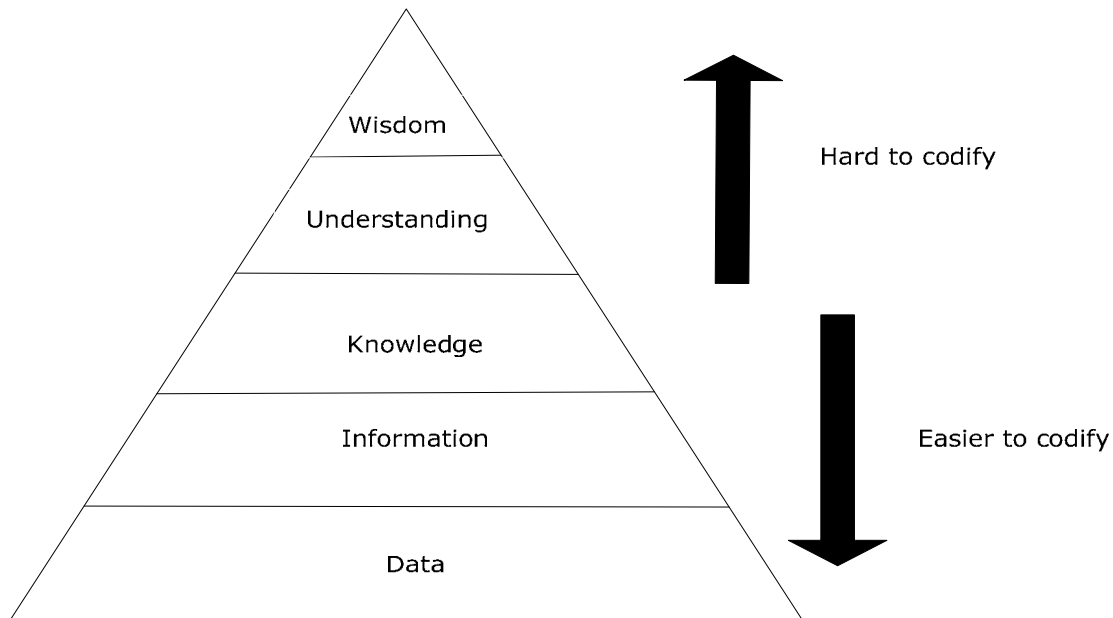

The bottom two layers of the hierarchy tend to relate strongly to the asset and operational data which reside in the GIS and SCADA respectively, and the summaries of this data that form one part of the decision making.

The third layer – knowledge – tends to be more broad and general in nature, and may include such things as technical standards that codify accumulated knowledge into a single useful document.

The top two layers tend to be very broad and are often difficult to define. It is at this level that key organisational strategies and processes reside at. As indicated in Figure 8(a) it is generally hard to codify these things, hence correct application is heavily dependent on skilled people.

1.6.1 Asset management processes

The asset management process prioritises the programs for maintenance and asset development to ensure optimum customer service and operational efficiency. Implicit in the asset planning process is an understanding and evaluation of the risks to operation and the consequences of failure. Also critical is the collection of information from which performance can be monitored and improvement targets set.

The systematic processes that make up the core of asset management practices are those that collect and analyse data. The main processes are:

- **Condition Assessment**
Every asset has a condition assessment action included in its maintenance program. This is used to confirm the necessity of further maintenance, target maintenance expenditure and provide ageing data.
- **Performance**
Analysis of reliability statistics provides information on the performance of assets, the effectiveness of work practices, and helps target work programmes which result in improved performance.
- **Asset Utilisation and Capacity**
Load growth and changing profiles are obvious inputs into planning. However security risk and quality issues also require adjustment when load use patterns change.
- **Risk Management**
Network related risks are identified and ranked by risk reduction outcomes to help prioritise work programmes.
- **Economic Optimisation**
The value of a network results from the asset management practices applied. Economic analysis can indicate whether valuation changes and lifecycle costs are in line with long-term sustainable objectives and therefore which tactics are appropriate for different network segments. Economic analysis is also applied to optimise the balance between capital and maintenance decisions across the life cycle of the network assets

- **Benchmarking**
Analysis of disclosure information and industry benchmarks identifies the practices that are most effective and the performance levels that can be achieved given inherent network characteristics.

1.6.2 Asset Management Systems

ENL uses the following information systems to store information on its assets, their condition and performance.

- **Works Database**
The Works Database provides job cost functionality and is used to manage faults, maintenance and work management activities. This is essentially a contract management and cost reporting tool. It provides information on progress, commitments, forecasts and cash flow.
- **Financials**
The company uses ACCPAC as its main financial management IT-platform. This is supplemented with Dbit to maintain the financial asset register, which is separate to the engineering asset database.
The Works Database is reconciled with ACCPAC during monthly reporting.
- **Network Control**
The SCADA system provides real time operational data and enables remote control of key components of the network.
- **Network Modeling**
ENL uses PSS/U (Power System Simulation/Utilisation) network modeling software to analyse the network and the impact of changes in utilisation and operation. The software is sufficiently sophisticated to permit advanced network optimisation and analysis and assist investment decision-making.
Visim is used as the main structural engineering tool for line design.
LV Drop software is primarily used for Low voltage design.
- **Asset Information Systems**
The Powerview Geographical Information system operating on a Microsoft Access Databases is used for management of asset information, maintenance and inspection records. A number of associated Microsoft Access Databases / applications are used in conjunction with the Powerview databases to manage non-spatial assets. Between 2002 and 2004, the compliance program and

associated data capture has driven major improvements in the completeness and quality of asset information.

Microstation Draughting Software is primarily used to maintain information in Schematic form. Complex structural and circuitry design information is also stored in the Microstation format. Hard copy records include Maps, field record books, and Maintenance/Commissioning Records.

Gentrak is the product used to manage ICP records in a Unidata Database format and linked to the GIS data.

1.6.3 Information Flows

The linkage and co ordination between ENL's asset management procedures and systems is shown below;

Key info systems & processes

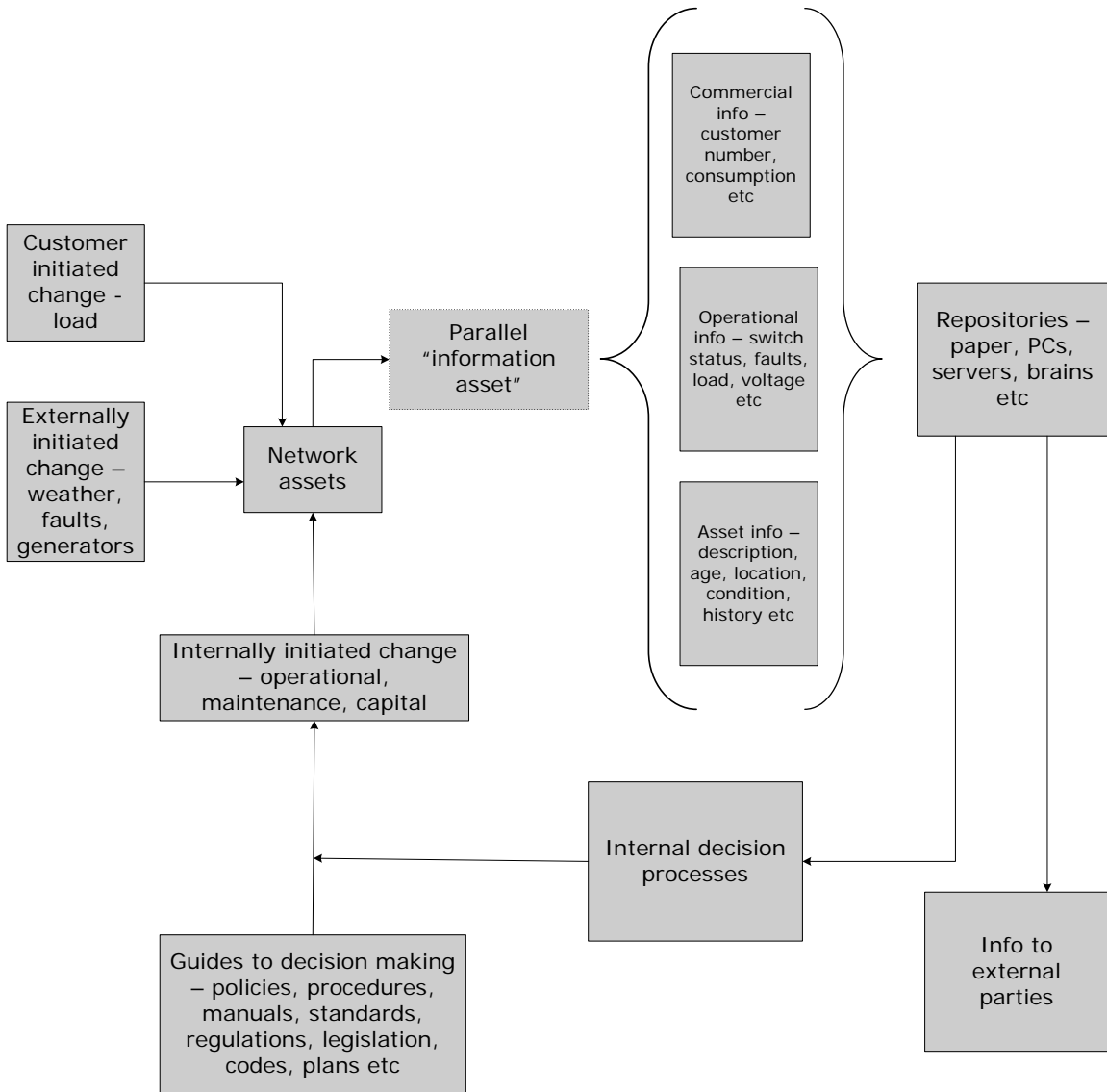

2. Details of ENL's assets

2.1 ENL's distribution area

2.1.1 Geographical coverage

ENL's distribution area broadly covers the East Cape and Northern Hawkes Bay areas as shown below within the red ring. This area almost exactly corresponds to the jurisdictions of the Gisborne and Wairoa District Councils.



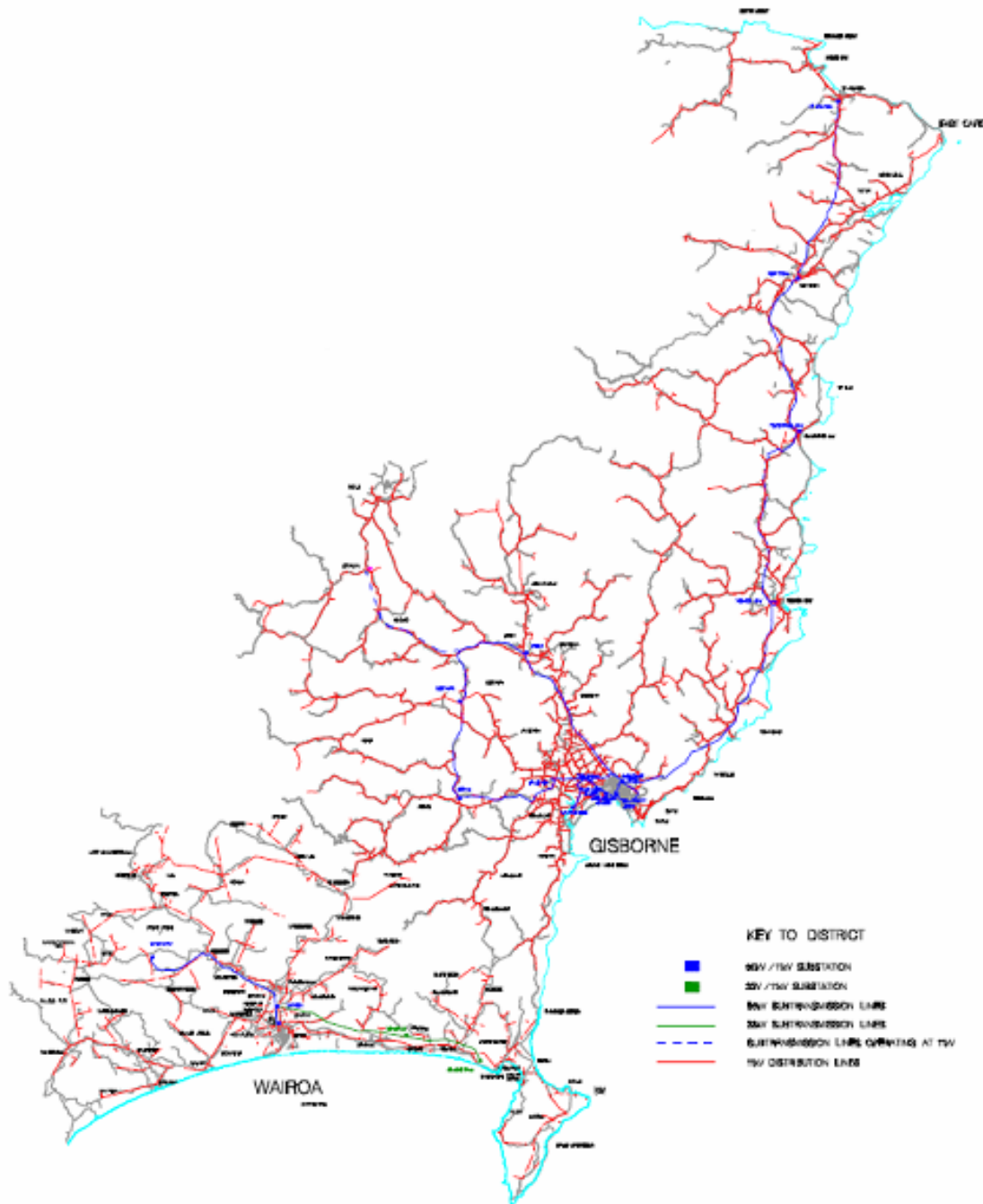

Topography ranges from fertile plains around Gisborne and Wairoa to rugged mountainous areas further inland.

2.1.2 Demographics

The population of ENL's distribution area is approximately 53,000 of whom about 31,000 live in the urban Gisborne area and a further

4,000 live in the urban Wairoa area. The remaining 18,000 live in small settlements (such as Te Karaka, Tolaga Bay, Tokomaru Bay, Ruatoria, Matawai and Mahia) and in rural areas. The last three censi indicate slightly declining populations in both the Gisborne and Wairoa Districts.

However any expected contraction of max demand or network investment requirements due to this declining population is likely to be more than off-set by decreasing occupancy rates (i.e. more dwellings but with fewer inhabitants), cheap electric heaters, cheap air-con units and new connections over-taking consolidation of ICP's (this era of consolidation is expected to come to an end within the next 3 years).

2.1.3 Key industries

Key industries relate strongly to the primary produce value chain – cultivation, harvesting, processing, storage and transportation of timber, root and leaf vegetables, pip and stone fruits, grapes, meat and fin fish. There are a number of significant processing and storage installations on the western outskirts of Gisborne, clustered in the Gisborne industrial estate, the Gisborne Port area and in Wairoa.

A key issue arising from the nature of these consumers is the increasing stringency of food safety regulations that require controlled temperature and humidity that in turn requires increased continuity of supply, improved restoration times and less flicker and sag.

EIL's commercial manager regularly engages with these customers and EIL has also used an external advisor to consult with these customers specifically on the issue of price and supply quality in 2004 and 2006.

2.1.4 Energy & demand characteristics

Key energy & demand figures for the 2005/06 year are as follows...

Parameter	Value	Trend
Energy conveyed	283162GWH	Slight decline in 2005/06 due to mild winter. Average increase of 4% p.a.
Maximum System demand	55.89 MW	Average increase of 2% p.a. excluding strategy change over the period.
Load factor	0.58	Improvement in Utilisation over

		time
Hours per year that firm capacity was exceeded	1481 HRS - 20%	Figure applies to Gisborne GXP only. No trend as load control and use of embedded generation influences results

The historical consumption p.a. shows 3.7% growth. The system demand trend has been significantly influenced by a change in Load control strategy from 2001 to 2004. The low figures for 2003/2004 were a result of the national energy crisis where advertising to control energy usage and energy retailer requests to control hot-water load more than that usually required for peak demand control had a high impact on demand. The differences between growth demand of 2% and the consumption indicate improvements in asset utilisation. ENL has endeavored to promote improved utilisation via its demand tariff pricing structure.

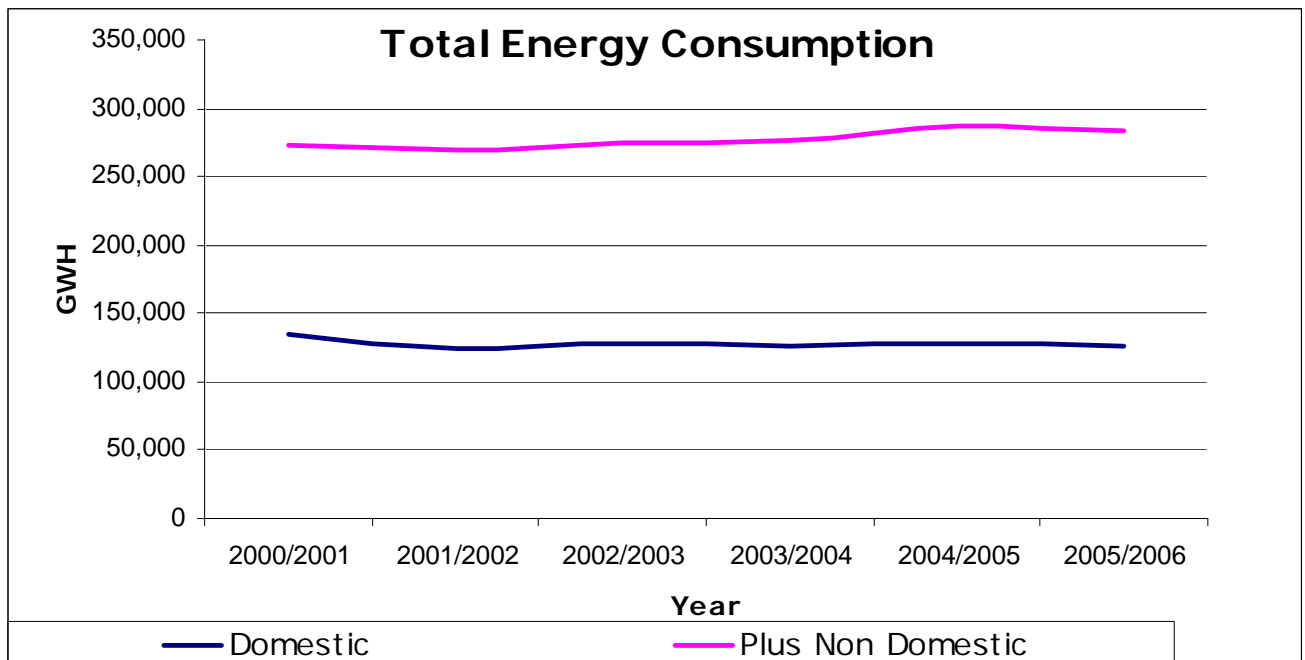

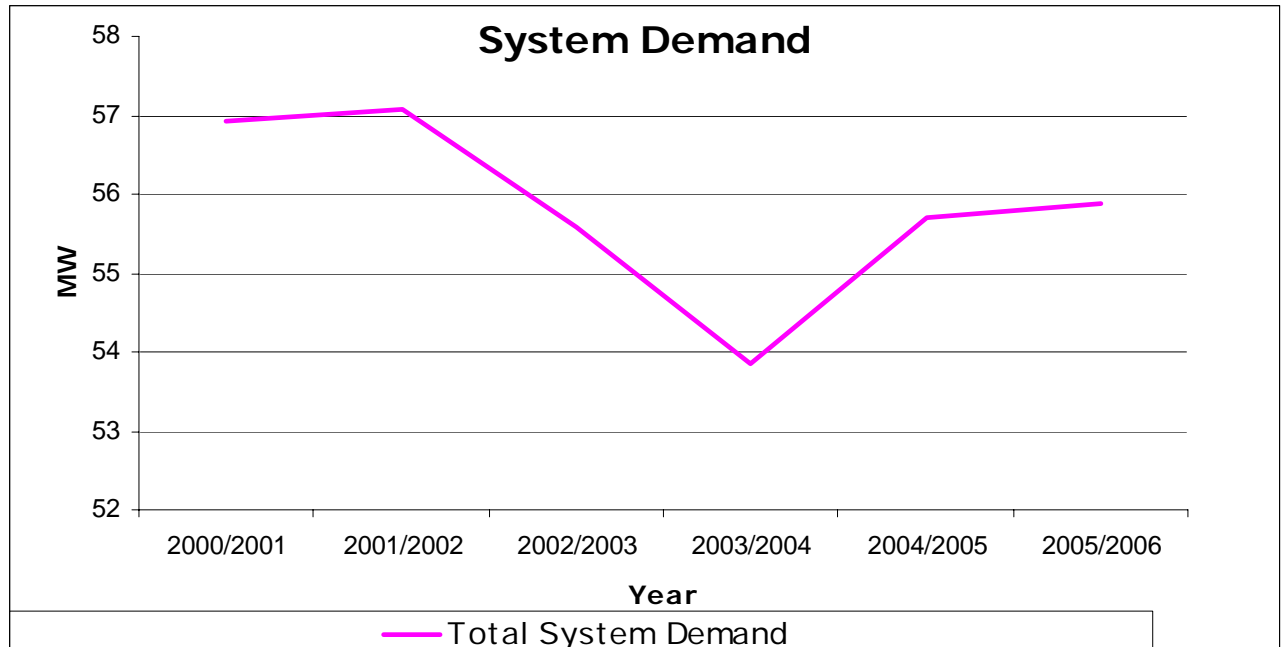

2.2 ENL's network configuration

To supply ENL's 24,864, (as at 01 April 2006), consumers ENL owns and operates the following three electrically separate networks which are ...

- The original Poverty Bay EPB network
- The Wairoa EPB and Wairoa MED networks which were merged to form a single entity following the local government reform of 1989.
- The Tuai network which initially was part of the Wairoa EPB

ENL acquired the network and generation business of Wairoa Power Ltd in 1999 which left Wairoa Power as a cashed-up shell company. Prior to this Wairoa Power had sold its retail business to TrustPower.

2.2.1 Bulk supply assets & embedded generation

2.2.1.1 Gisborne Region Bulk Supply

Gisborne GXP

ENL takes supply for the Gisborne region network at Transpower's Massey Rd GXP on the northern outskirts of Gisborne. This is supplied by a double circuit 110kV tower line from Waikaremoana which splits into two double-pole under-hung circuits near Patutahi (about 7km

west of Gisborne) and then re-converges into a double circuit tower configuration for about 12 spans immediately west of Massey Rd.

Massey Rd has two 30MVA 110/50kV transformers (designated T3 and T4) which supply a 50kV bus via two 50kV incomers. ENL is supplied by four 50kV feeders, two on each side of the bus. The biggest issue with Massey Rd is the lack of true (n-1) security of supply into the GXP from Tuai which will be exacerbated as ENL's net max demand increases...

- ENL's current net max demand of 44.8MW cannot be supplied by one 110/50kV transformer.
- The 110kV circuits into Massey Rd are currently summer rated at only 38MW each. ENL's net max demand exceeds this for about 800 hours per year. It is noted that Transpower's efforts to obtain an additional line easement 5 years ago have lapsed with their preferred options being local generation, load control and "tactical upgrades" such as thermal re-rating of lines.
- The double-circuit 110kV configuration in part installed on single structures does not give true (n-1) security.
- These two circuits are supplied by a ring-bus at Waikaremoana that is coupled by a 110kV breaker that doesn't have bus zone protection hence any bus fault at Waikaremoana will trip both 110kV lines to Massey Rd.

Other issues with Massey Rd are...

- There are no on-load tap changers on the 110/50kV transformers.
- The 110kV capacitor banks absorb ENL's load control signals.
- Earthing resistors are required to limit earth fault levels.
- ENL has no control or indication for the 50kV circuit breakers.

Transpower is working with ENL to address this by installing two 60MVA 110/50kV transformers at Massey Rd with tap changers and earthing resistors and a 50kV bus upgrade to cope with the additional capacity. This project is due for completion in April 2007 and will provide 45MVA of firm capacity. The 110kV line constraints will be addressed in subsequent years.

Tokomaru Bay GXP

Historically ENL also took supply from Transpower via a GXP at Tokomaru Bay which was supplied by a 110kV single-circuit tower line from Massey Rd. However ENL relinquished supply from this GXP in 2000 and instead supplies this area from its own 50kV sub-transmission network and secures supply with its own diesel generators as required.

The 110kV line is currently left energised to provide capacitive voltage support for Massey Rd but is disconnected at Tokomaru Bay by an open 110kV incoming isolator. The transformers from the site have been removed. ENL's 50kV sub-transmission network is isolated from the GXP by an open isolator.

Diesel generation

ENL owns six 1MWe and one 0.6MWe diesel generators which are housed in standard shipping containers and weigh about 23 tons each. These can be deployed anywhere in the network that is accessible to a large mobile crane and where up to 1MW can be injected at 11kV with the energy being sold to Contact Energy.

Benefits derived from operating these generators include...

- Reduction of ENL's max demand at GXP's by anything up to 5MW (using ENL's load control can relieve a further 4MW).
- Easing of constraints on ENL's network, thereby avoiding network investment that would only be required for short periods.
- Providing localized continuity of supply during outages due to sub-transmission faults or as required to carry out network maintenance.

The 1MWe generators are located at Matawhero, Puha, Ruatoria, Te Araroa, Tolaga and Mahia on a semi-permanent basis. The 0.6MWe unit which has no synchronizing or metering capability is used only as required in an islanded mode to maintain customer supply to isolated sections of 11kV line during planned and/or unplanned outages.

Proposed generation

ENL has also identified the following generation possibilities;

- A 12MWe wind-farm on the East Coast

- A 10MWe bio-mass fuelled combined heat & power plant.
- A 6MWe gas-fired cogeneration plant.

Analysis has indicated that these projects may be unviable without the ability to...

- Capture the retail margin (which broadly requires a method of selling generated electricity to other than existing gentailers who are only prepared to pay the spot price and then capture the retail margin for themselves).
- Avoid the additional costs of separate governance and management structures, processes and systems.

2.2.1.2 Wairoa bulk supply

Wairoa GXP

Supply to the Wairoa GXP is by a double-circuit 110kV line from Waikaremoana.

The GXP comprises two 10MVA 110/11kV transformers and an 11kV board comprising two incomers, a bus tie and six feeders. Since ENL rationalised its supply configuration in 2002 only 2 of the 6 feeders are used. ENL also owns and operates an 11/33kV step-up substation adjacent to the Wairoa GXP to supply the Mahia Peninsula at 33kV that includes a pole-mounted 11kV incoming breaker and a load control plant injecting at 11kV.

Issues at this site include...

- Six switch panels on the Transpower 11kV board are surplus to ENL's requirement.
- The initial 40m of each of the 2 outgoing feeder consists of cable that is limited to 8MW.
- There is potential for between 20MW and 40MW of gas-fired generation near Frasertown that would need to be connected to ENL's network as the Transpower connection charges would be excessive.

- The 11/33kV transformer is already overloaded during summer because of high loading at Mahia.
- The proximity of the 50kV line from ENL's Waihi power station to ENL's Kiwi substation lends itself to rationalising the whole supply to both Wairoa and Mahia.

Tuai GXP

ENL has approximately 600kVA of load in and around Waikaremoana which is supplied by a 10MVA 110/11kV transformer and two KFE reclosers. These reclosers were installed in 2000, and are fitted with Transpower SCADA controls. However the SCADA controls provide indication only hence restoration times are long as a tripping usually requires Transpower's contractor to come from Napier which generally requires about 3 hours from the trip event.

A key action for this supply is to obtain an alternative to the existing Transpower supply which is currently disproportionately expensive to maintain. Options considered include...

- Building a line to Waikaremoana from the end of the existing Wairoa 11kV network which comes within about 1km of Waikaremoana. This has been given some detailed consideration but is a very high cost option to supply only 600kVA because of the 11kV reinforcement required all the way from Wairoa. A variation to this option could include converting the 50kV Waihi line to 33kV and provide a 6.6/11/33kV transformer at Waihi.
- Taking an 11kV supply straight from the generation bus at Tuai.

Generation

ENL owns and operates a 5MWe hydro station at Waihi which is effectively limited to peak chopping by the limited water storage. This is strongly embedded in ENL's network and supplies a 50kV line to ENL's Kiwi substation via a 6.3MVA 6.6/50kV transformer. The generation from Waihi is sold to TrustPower.

ENL also uses one of its 1MWe diesel generators to support demand at Mahia over Christmas and Easter until the Mahia 33kV extension is completed.

2.2.2 Sub-transmission network

2.2.2.1 Gisborne Region sub-transmission

The Gisborne Region sub-transmission network comprises the following asset configurations...

- A 50kV spur from Massey Rd up the east coast that was originally constructed by the NZED as far as Tokomaru Bay (1955) then to Ruatoria (1964) and finally to Te Araroa (1971). Ownership of the Massey Rd – Tokomaru section of this line was transferred to the PBEPB in 1980 when the NZED completed its own 110kV tower line. A switching station at Goodwin Rd was installed to prevent faults on the Massey Rd - Tokomaru 50kV line from causing tripping of the 50kV circuit to Kaiti and the Port. This consists of a SCADA-controlled circuit breaker with an associated isolator/earth switch and fence enclosure. It was constructed in 2002.
- Two 50kV lines from Massey Rd to Makaraka.
- A single open 50kV ring to the west of Gisborne supplied from half way along one of the Makaraka lines at the Hexton switching station to supply 50/11kV substations at Puha, Ngatapa, Pehiri, Patutahi and back to Makaraka. Between Puha and Ngatapa there is a 50kV spur supplying Matawai which operates at 11kV. The Hexton switching station was installed as part of the project to construct the second 50kV line into Makaraka from the Massey Rd – Puha circuit in 2001 to prevent faults in the Puha–Ngatapa-Pehiri-Patutahi segment of the 50kV ring from affecting supply to Makaraka, Matawhero and Parkinson St.
- Two 50kV urban rings, one supplying 50/11kV substations at Kaiti, Carnarvon St and the Port from Massey Rd, and the other supplying Matawhero, JNL and Parkinson from Makaraka. These rings can be connected between Carnarvon and Parkinson which occurs regularly to enable maintenance of Transpower assets on the 50kV structures at Massey Rd without loss of supply.

These are depicted in Figure 2.2.2.1(a) below....

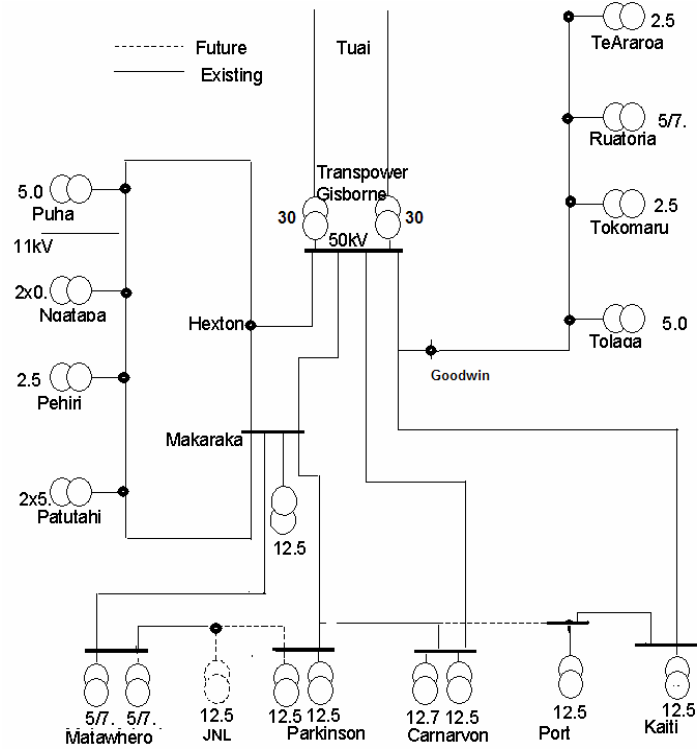

2.2.2.2 Wairoa sub-transmission

The Wairoa sub-transmission network comprises two main components...

- A 33kV line stretching 35km from ENL's 11/33kV step-up substation adjacent to the Wairoa GXP to ENL's Blacks' Pad substation at the north end of the Mahia peninsula. Prior to 2000 this line was operated at 50kV despite parts of the line being only insulated to 33kV.
- A 50kV line from Waihi hydro to ENL's Kiwi substation which includes some under-built 11kV in places.

Figure 2.2.2.2(a) below depicts the Wairoa sub-transmission network...

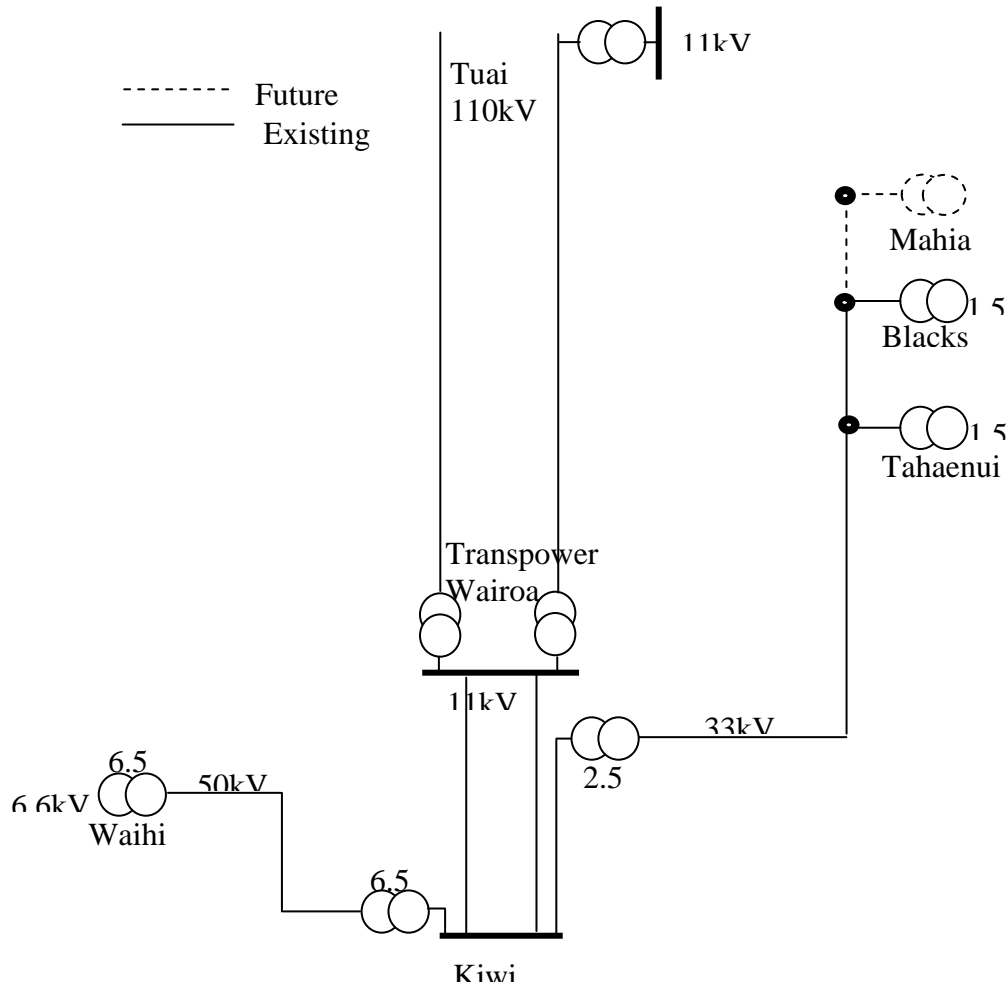

2.2.3 Zone substations

2.2.3.1 Gisborne Region Substations

ENL's Gisborne region substations are summarised in the following table and described more fully by the following narratives.

Sub.	Area supplied	Description
Carnarvon	CBD and central Gisborne.	Substantial two transformer urban sub.
JNL	Primarily supplies a single large consumer, likely to supply additional similar customers in the medium-term.	Single transformer industrial sub with provision for a second transformer.
Kaiti	Residential Kaiti area, some load being shifted to Port.	Substantial single transformer urban sub with provision for second transformer.
Makaraka	Semi-rural Makaraka area immediately west of Gisborne.	Substantial rural single transformer sub, also provides significant switching point for

		the 50kV ring and also for ripple injection.
Matawhero	A number of large produce processing consumers about 8km west of Gisborne.	Substantial two transformer industrial sub.
Ngatapa	Rural Ngatapa area and surrounding district about 30km west of Gisborne.	Minimalist single transformer rural sub.
Parkinson	Industrial estate in south-west Gisborne.	Substantial two transformer urban sub.
Port	Port area of Gisborne including taking residential load from Kaiti and CBD load from Carnarvon.	Substantial single transformer urban sub.
Patutahi	Semi-rural area around Patutahi about 18km west of Gisborne.	Minimalist rural sub with two banks of three 1-phase transformers.
Pehiri	Rural area around Pehiri about 30km west of Gisborne.	Single transformer rural sub.
Puha	Mountainous rural area around Te Karaka, Whatatutu and Matawai about 40km north-west of Gisborne.	Three 1-phase transformer substantial rural sub supported by 1MWe of diesel generation.
Ruatoria	Small settlement of Ruatoria and surrounding district about 90km north of Gisborne.	Substantial single transformer rural sub supported by 1MWe of diesel generation.
Te Araroa	Small settlement of Te Araroa and surrounding district about 115km north of Gisborne.	Substantial single transformer rural sub supported by 1MWe of diesel generation.
Tokomaru	Small settlement of Tokomaru By and surrounding district about 60km north of Gisborne.	Substantial single transformer rural sub.
Tolaga	Small settlement of Tolaga Bay and surrounding district about 35km north of Gisborne.	Substantial three 1-phase transformer rural sub supported by 1MWe of diesel generation.

Carnarvon St

Supply to Carnarvon is as follows...

- A single 50kV line from Massey Rd.
- A teed 50kV line from the Port that can connect to Parkinson.

The 50kV bus at Carnarvon includes a 50kV circuit breaker allowing operation as a closed ring. There are two 3-phase 50/11kV 12.5MVA

transformers and an 11kV board comprising 2 incomers, a bus tie and 9 feeders.

JNL

Currently nearing completion the JNL substation was constructed in 2005. The 11kV switchboard was livened mid 2005 and supplied load to JNL via a 50kV line from Matawhero operating at 11kV.

The substation comprises...

- A 50kV Line from Matawhero Substation
- A 50kV line nearing completion from Parkinson St substation
- A 50kV bus CB to allow closed 50kV ring operation
- 1 3-phase 12.5MVA transformer bank with room for a second transformer
- A Portacom switch room housing an 11kV Reyrolle switchboard with 1 incomer, 2 feeders, a fuse switch for local service and a bus coupler for future extension or generator connection.

Kaiti

The Kaiti area was originally supplied at 11kV directly from Massey Rd, but by the mid-1980's this load could no longer be adequately supplied at 11kV so in 1987 the PBEPB built a new substation. Kaiti now comprises...

- An incoming 50kV line from Massey Rd.
- An outgoing 50kV line to the Port.
- A minimum oil 50kV circuit breaker providing incoming protection for the transformer and a 50kV bus breaker for closed ring operation.
- A single 12.5MVA 50/11kV transformer (with provision for a second transformer).
- An 11kV Reyrolle board with 2 incomers, a bus tie, a fuse switch and 7 feeders.

Key issues at Kaiti are...

- The close proximity to houses means that transformer noise is a potential issue which is exacerbated by the high impedance of the transformer. Some form of noise reduction fencing may be required in the future.
- The #1 incomer cables have failed in service and the transformer currently supplies load via incomer #2. Replacement of the #1 incomer cables will be required if a second transformer is ever installed at the site.
- Seismic restraint of the transformer is considered marginal. The mounting arrangement will be upgraded when the transformer requires major routine maintenance.

Makaraka

Makaraka was originally constructed in 1974 as a switching point for the Massey Rd - Patutahi 50kV line which also teed off to Carnarvon. A second incoming 50kV line from Massey Rd, which has been tapped off the Massey Rd - Puha line, was built in 2001. At time Makaraka was upgraded from a switching station to a single transformer zone substation by the installation of a new 12.75MVA transformer.

Makaraka now comprises...

- Two incoming 50kV lines from Massey Rd (one via Hexton).
- A 12.5MVA 50/11kV transformer capable of running off either side of a split 50kV bus.
- A Portacom switch room with an 11kV board comprising an incomer, 4 feeders and a fuse switch.
- A 50kV load control injection coupling cell (outdoor).
- A hut containing a load control static converter.
- Three outgoing 50kV circuits to Patutahi, Matawhero and Parkinson.

Matawhero

ENL built Matawhero in 2000 as a single transformer substation primarily to supply JNL because the existing 11kV cables from Parkinson had become inadequate (although they have been left in situ to provide additional security of supply). In 2003 ENL augmented Matawhero with a second transformer, a second 50kV breaker and two additional 11kV feeders to supply the rapidly growing cold storage load in this area. Matawhero now comprises...

- An incoming 50kV line from Makaraka.
- An outgoing 50kV line to the new JNL substation.
- A 50kV bus circuit breaker to allow 50kV operation as a closed ring.
- Two 5/7.5MVA 50/11kV transformers.
- A Portacom switch room with an 11kV board comprising two incomers, a bus coupler, five feeders and a fuse switch.

The key issue at Matawhero is the proximity of a major river.

Ngatapa

The PBEPB built Ngatapa in 1964 as part of closing the 50kV ring between Puha and Patutahi. Ngatapa currently consists of...

- An incoming and an outgoing 50kV line forming the 50kV ring from Makaraka to Hexton (which also supplies the Patutahi, Pehiri and Puha Substations).
- Two 500kVA 50/11kV transformers. Because these don't have on-load tap changers, a separate 11kV regulator is used to regulate voltage.
- A single 11kV incomer and four 11kV feeders that include pole-mounted SF₆ GVR breakers on an outdoor copper wire bus and wooden pole structure.

Key issues with Ngatapa are...

- It currently falls a long way short of ENL's accepted earthing, drainage and oil containment standards.

- There is no 50kV protection – reliance is placed on a 50kV line breaker at Pehiri to clear transformer faults.

Ngatapa is ideally suited to upgrade as an alternative supply to Matawai and some support to Puha. The 11kV line would need to be upgraded along Hihiroroa Rd then extended under the 50kV line to the top of Otoko Hill with dog conductor.

Parkinson

The industrial load in and around Parkinson St was originally supplied at 11kV from Massey Rd (similar to the domestic load in Kaiti) which was no longer adequate by the mid-1980's. In 1987 the PBEPB built a zone substation in Parkinson St in an identical configuration to Kaiti, and then in 2004 a second transformer was added.

Parkinson currently takes supply from a tee off the Makaraka – Carnarvon 50kV line and will also be connected to the new JNL dedicated substation via a 50kV line. Parkinson currently comprises...

- Two 12.5MVA 50/11kV transformers. The first was installed in 1987 and the second is the former Carnarvon T1 that was refurbished and installed in 2004.
- A 50kV bus breaker to allow operation as a closed ring.
- An 11kV Reyrolle board with 2 incomers, a bus tie, a fuse switch and 7 feeders.
- An SF6 RMU connected to one of the feeders to provide for the local service supply transformer.

The single outstanding issue with Parkinson is the boundary fence is unsatisfactory.

Port

Port was completed in December 2003 to enable continued load growth at Kaiti and Carnarvon to be off-loaded. This is also the first stage of improving security provision for the Kaiti area (the second stage will be completion of the 50kV ring to Carnarvon). Port currently comprises...

- An incoming 50kV line from Kaiti.

- A second 50kV line from Carnarvon.
- A 50kV bus breaker to allow operation as a closed ring.
- A 12.5MVA 50/11kV transformer.
- An 11kV Reyrolle board with an incomer, a fuse switch and 4 feeders.

Patutahi

Patutahi was built in 1929 by the State Hydro Electric Department as the main bulk supply point to the Gisborne area. The following upgrades have taken place over the years....

- The original transformers were replaced with other ex-NZED transformers dating from the 1940's.
- The original brick building was considered an earthquake risk and was replaced in 1991.
- The original 11kV board was replaced in 2000 with second-hand Reyrolle LMT panels and new VCB's.
- The 50kV air operated breakers were replaced in 2006.

Patutahi now comprises...

- An incoming 50kV line from Massey Rd via Makaraka.
- An incoming 50kV line from Massey Rd via Makaraka, Hexton, Puha, Ngatapa and Pehiri.
- A 50kV line breaker for isolating faults from Pehiri.
- Two banks of 50/11kV 1.67MVA 1-phase transformers. There are also two spares, one of which has failed in service and is considered uneconomic to repair.
- A single 11kV incomer, four feeders and one fuse switch.
- An outdoor structure consisting of mostly steel lattice and concrete poles with copper wire bus bar.

The key issues at Patutahi are mainly that the original design standards for earthing, construction, drainage and oil containment have been overtaken by modern standards. These will be addressed as part of a planned conversion of Patutahi to a single transformer substation that will be secured by off-loading capability to Matawhero and Makaraka.

Pehiri

The PBEPB built Pehiri in 1964 along with Ngatapa as part of the 50kV ring extension from Puha to Patutahi. ENL upgraded Pehiri in 1998 to include a 2.5MVA transformer with an on-load tap changer. If this transformer needs to be removed from service ENL can supply most of Pehiri's load via the 11kV from Patutahi and using an old 11kV regulator at Pehiri to boost the voltage.

Pehiri now comprises...

- An incoming and an outgoing 50kV line which forms part of the 50kV ring from Makaraka to Hexton.
- A 2.5MVA 50/11kV transformer.
- An 11kV voltage regulator.
- An 11kV incomer and four 11kV feeders on an outdoor bus.

Pehiri has the following issues...

- An old Maier 50kV oil breaker is still in service.

Puha

The PBEPB built Puha in 1960 to supply the Te Karaka, Whatatutu and Matawai areas to the north-west of Gisborne. Originally Puha was supplied by a single 50kV line from Massey Rd, but in 1963 Puha was given a second supply when the 50kV ring was closed. Since the original construction ENL has done the following upgrades...

- Earthing and transformer bunding upgrades.
- Replacement of the outdoor 11kV bus and breakers with an ABB Safepus SF₆ indoor board.

- Installation of a new 50kV Merlin Gerin SF6 breaker on T1.

Puha currently comprises...

- An incoming and an outgoing 50kV line forming the 50kV ring from Makaraka to Hexton.
- Three 1.67MVA 50/11kV 1-phase transformers.
- An 11kV board comprising a single incomer, a fuse switch and four feeders.
- One of ENL's 1MWe diesel generators to augment the limited transformer capacity for which an RMU is being installed.

Key issues with Puha include...

- Max demand cannot be fully off-loaded to other substations via the 11kV. In addition to operating one of ENL's 1MWe diesels at Puha, this is also being addressed by providing for Matawai to be supported via an upgrade at Ngatapa, extending the Ngatapa feeder to Otoko Hill and possibly reinforcing the Lavenham feeder from Patutahi.
- There is no oil separation capability, and any work on this has been deferred to coincide with replacement of the transformer bank.

Ruatoria

The PBEPB built Ruatoria in 1965 to supply the wider Ruatoria area including Wahareponga, Kopuaroa and Whakawhitira. Over the last decade ENL has upgraded Ruatoria as follows...

- In 1998 ENL installed two refurbished MetroVick 50kV bulk oil breakers, a new 50kV bus and four new SF₆ pole-mounted 11kV breakers.
- In 1999 ENL installed a new 5/7.5MVA 50/11kV transformer and upgraded the bunding, and also did some earthing upgrades.
- In 2001 ENL replaced the four pole-mounted 11kV breakers with an indoor Safeplus SF6 board in a Portacom. This enabled removal of

the outdoor 11kV structure and reduction of the yard size as well as improving the earthing and yard surface.

Ruatoria currently comprises...

- An incoming 50kV line from Tokomaru Bay.
- A 5MVA 50/11kV transformer.
- An 11kV board comprising a single incomer, a fuse switch, three feeders and a generator connection point.
- A 1MWe diesel generator.

Te Araroa

The PBEPB built Te Araroa in 1971 to supply the wider Te Araroa area including Hicks Bay, Horoera and Awatere Valley. Recent upgrades include...

- In 1998 ENL replaced the original 11kV switchgear with second hand Reyrolle LMT panels and new VCB's and also installed a 2.5MVA transformer with an on-load tap changer with bunding and oil containment facilities.
- In 2001 ENL installed a MetroVick 50kV bulk oil breaker on the transformer and removed the earth throw switch originally used for transformer protection. The voltage regulator that was used for security was also removed after it failed in service.

Te Araroa currently comprises...

- A single incoming 50kV line from Ruatoria.
- A single 2.5MVA 50/11kV transformer.
- An 11kV board comprising a single incomer, a fuse switch, three feeders and a generator connection point.
- A 1MWe diesel generator.

Key issues with Te Araroa include...

- Full load cannot be supplied on the 11kV from Ruatoria.

- Subsidence has caused minor cracks in the building block work which is being monitored.

Tokomaru Bay

The PBEPB built Tokomaru in 1958 adjacent to the Transpower GXP to supply the surrounding area including Te Puia Springs and Mawhai Point. Since the original construction ENL has upgraded Tokomaru as follows...

- In 1998 ENL installed a new 2.5MVA transformer with an on-load tap changer and bunding. ENL also upgraded the earthing at the same time.
- In 1999 ENL replaced the 11kV switchgear with a second hand Reyrolle LMT board with new VCB's.
- In 2001 oil separators were added.

Tokomaru currently comprises...

- A single incoming 50kV line from Tolaga Bay.
- A single outgoing 50kV line to Ruatoria.
- A single 2.5MVA 50/11kV transformer.
- An 11kV board comprising a single incomer, a fuse switch and three feeders.
- A single 50kV connection to Transpower's Tokomaru Bay GXP (from which ENL relinquished supply in 2000).

Tolaga Bay

The PBEPB built Tolaga Bay in 1963 to supply the surrounding area including Hauiti and Wharekaka. Since the original construction ENL has upgraded Tolaga as follows...

- In 2000 ENL installed a MetroVick 50kV bulk oil breaker to provide transformer protection. The earthing for the remaining substation yard was upgraded as part of the project.

- In 2001 ENL undertook a significant rationalisation that included erecting a switch-room and installing an indoor Safeplus SF₆ board, removing and scrapping the spare 50/11kV transformer, removing the out-dated 11kV outdoor bus and halving the size of the yard.

Tolaga now comprises...

- A single incoming 50kV line from Goodwin Rd switching station.
- A single outgoing 50kV line to Tokomaru.
- A 5MVA 50/11kV bank comprising three 1.67MVA transformers and a spare.
- An 11kV board comprising a single incomer, a fuse switch and four feeders.
- A 1MWe diesel generator.

Key issues at Tolaga include...

- There is currently no oil separation. Installation has been deferred to coincide with replacement of the transformers.
- All but 200kVA of load can be back-fed from adjacent substations on the 11kV. The remaining 200kVA can be adequately supported by the diesel generator.

2.2.3.2 Wairoa Region Substations

ENL's Wairoa substations are summarised in the following table and described more fully by the following narratives...

Sub.	Area supplied	Description
Blacks Pad	Opoutama, Kaiwaitau and the Mahia peninsula.	Minimalist single transformer rural sub supported by 1MWe of diesel generation over Christmas and Easter.
Kiwi	Urban Wairoa including AFFCO plant.	Substantial switching station supplied at 11kV from Transpower and houses the 50/11kV step-down transformer for the Waihi line.
Tahaenui	Semi-rural area around Nuhaka and Morere, also back-feeds to Blacks Pad.	Minimalist single transformer rural sub.
Waihi	Step-up substation at 5MW hydro	Minimalist single transformer sub.

	station.	
--	----------	--

Blacks Pad

Blacks Pad is located at the north end of the Mahia peninsula. Initially the substation included three 50/11kV single-phase transformers totaling 5MVA supplied by a 50kV line from Wairoa. In 2000 the 50kV line was formally converted to 33kV to improve reliability and the transformer replaced with a single 1.5MVA 3-phase transformer. Other equipment includes 33kV drop-out fuses and an 11kV pole-mounted circuit breaker. Bunding, fencing and earthing upgrade work was all completed in 2000 in conjunction with the transformer change.

A key issue with Blacks Pad is that the Christmas and Easter load at Mahia often exceeds the 1.5MVA transformer rating which has been relieved by operating one of ENL's diesel generators at Mahunga. Development actions include the Mahia 33kV extension project.

Kiwi

Kiwi was built as part of the Waihi hydro station in 1983 and takes supply as follows...

- Via a 6.3MVA 50/11kV transformer from Waihi.
- Via two 11kV feeders from the Wairoa GXP.

The 11kV board includes two incomers, a bus tie and seven out-going feeders. Key issues with Kiwi include...

- The risk of minor flooding which happens relatively frequently and places supply to almost the entire Wairoa network at risk. A stop bank around the perimeter of the substation is required to reduce this risk.
- Oil capture and separation facilities would be required for the 50/11kV transformer but this transformer will be removed as part of a long term 33kV development plan.
- The short cable lengths from the switchgear to the overhead lines outside the substation perimeter are limited to about 8MW each limit and will need upgrading as the load grows.

Tahaenui

Tahaenui was built in 2001 and is located between Wairoa and Blacks Pad and comprises incoming 33kV drop out fuses, a 1.5MVA 3-phase transformer with manual tap settings, a pole mounted 11kV circuit breaker and an 11kV RMU. Tahaenui is used primarily to supply Morere and also provide limited 11kV back-feeding capability to Blacks Pad. There are no current issues with Tahaenui.

Waihi power station

Waihi Power Station is a 5MWe hydro power station located off the highway between Frasertown and Tuai. Assets at the site that come within the scope of this AMP include the 6.3 MVA 6.6/50kV transformer and the 50kV line from Waihi to Kiwi. The transformer installation includes oil separation facilities.

Waihi is potentially ideally located to provide an 11kV supply to the immediate area and also back feed into the far ends of the Raupunga and Frasertown 11kV feeders. Plans have been developed to rationalise the 50kV line and 6.6/50kV transformer at Waihi with distribution assets solving a number of development issues.

A key issue with Waihi is that any transformer tripping will activate a phase to phase 50kV throw switch to isolate the 50kV line between Waihi and Kiwi.

2.2.4 Distribution network

2.2.4.1 Coverage

ENL's distribution network is clustered mainly along the east coast from Te Araroa in the north to Raupunga in the south-west. Isolated inland areas such as Matawai tend to be fed by spur lines that traverse rugged uninhabited areas. The distribution network is solely 11kV (no 6.6kV or 22kV) and comprises the following...

- 2,667km of 3-phase overhead.
- 131km of 1-phase overhead.
- 126km of 3-phase underground cable.
- 3km of 1-phase underground cable

Note the above lengths include 360km of privately owned overhead line and 2.7km of privately owned underground cable.

2.2.4.2 Configuration

In rural areas the configuration is predominantly radial with only some meshing between feeders and between adjacent zone substations. A high degree of meshing exists in the urban Gisborne and Wairoa areas via either ABS's or RMU's.

2.2.4.3 Construction

ENL's network construction differs between rural and urban as follows...

- Rural areas are predominantly wooden pole, flat construction with wooden cross-arms and pin insulators.
- Urban areas are predominantly concrete pole with wooden cross-arms.
- Cable network is concentrated in the CBD and newer subdivisions.

ENL's past standard of 11kV line construction uses a range of conductors as shown in the following table:

CONDUCTOR TYPES 11KV	
conduct_code	Length km
19/14 Cu	46.98
19/16 Cu	39.29
19/17 Cu	9.57
19/18 Cu	2.76
3/12 Cu	2.21
3/12 St	245.60
3/128 Cu	13.28
7/.093 Cu	33.51
7/.118 Al	1.74
7/.118 Cu	37.11
7/12 Cu	0.70
7/14 Cu	565.91
7/14 St	2.62
7/16 Cu	446.31
7/16 St	378.29
Cockroach	0.13

CONDUCTOR TYPES 11KV	
conduct_code	Length km
Dog	78.45
Ferret	121.46
Flounder	18.73
Gopher	152.14
Kutu	0.41
Magpie	26.05
Mink	4.38
No 6 St	0.41
No 8 Cu	28.78
No 8 Fe	0.49
No 8 St	26.96
Rabbit	4.43
Racoon	34.11
Rango	55.41
Robin	13.60
Shrike	14.68
Squirrel	3.17
Swallow	3.25
Weke	34.69
Swan	5.39

-

2.2.4.4 Per substation basis

On a per substation basis the split of distribution network is presented in the following sections. Customer density is obviously a strong driver of viability and significantly influences ENL's allocation of time, effort and funds.

Gisborne

Sub.	Line length (metres)	Customers	Customer density
Te Araroa	136124	475	4
Ruatoria	198416	769	4
Tokomaru Bay	196634	576	3
Tolaga Bay	191739	646	4
Kaiti	100485	3492	35
Carnarvon	53479	3936	76
Parkinson	30270	1899	64
Makaraka	157838	3249	21

Patutahi	290576	1425	5
Pehiri	151863	272	2
Ngatapa	128905	267	2
Puha	414552	1105	3
JNL	0	0	0
Matawhero	29093	224	8
Port	46773	1707	37
Totals	2,129,112	20,042	

Wairoa

Sub.	Line length (metres)	Customers	Customer density
Tuai	133995	372	3
Kiwi	504295	3361	7
Blacks Pad	94568	815	9
Waihi	0	0	0
Tahaenui	64364	274	5
Totals	797,223	4,822	

2.2.5 Distribution substations

Just as zone substation transformers form the interface between the 50kV and 11kV networks, distribution transformers form the interface between ENL's 11kV and LV networks. These distribution substations range from 1-phase 15kVA pole-mounted transformers with only minimal fuse protection to 3-phase 1,500kVA ground-mounted transformers dedicated to single customers.

Rating	Number			
	Gisborne		Wairoa	
	Pole	Ground	Pole	Ground
1-phase up to 15kVA	621	2	242	2
1-phase 30kVA	23	2	109	0
1-phase 75kVA	0	0	1	0
3-phase up to	1426	28	332	5

30kVA				
3-phase 50kVA	156	12	67	4
3-phase 100kVA	41	46	29	11
3-phase 200kVA	0	81	11	28
3-phase 300kVA	3	191	2	17
3-phase 500kVA	0	43	0	7
3-phase 750kVA	0	1	0	0
3-phase 1000kVA	0	15	0	0
3-phase 1500kVA	0	2	0	0
Total	2270	423	793	74

For management purposes ENL also classifies its nine 11kV voltage regulators as distribution transformers...

Location	Purpose
Pehiri	Security
Kopuaroa (between Ruatoria and Tokomaru)	Security
Tatapouri (between Kaiti and Tolaga)	Distance boost
Ngatapa	Compensate for absence of OLTC.
Matawai	Distance boost
Waingake	Support water works
Nuhaka	Distance boost. Has failed in service and will be removed, but function largely superseded by Tahaenui substation.
Waihua (west of Wairoa)	Distance boost
Mahia	Distance boost

2.2.6 LV network

2.2.6.1 Coverage

ENL's LV networks are predominantly clustered around each distribution transformer. The coverage of each individual LV network tends to be limited by volt-drop to about a 200m radius from each transformer hence LV coverage is not as extensive as 11kV.

2.2.6.2 Configuration

The LV networks are almost solely radial with minimal meshing even in urban areas because of excessive volt-drop in long thin conductors.

2.2.6.3 Construction

Construction of LV network varies considerably and can include overhead LV only, LV under-built on 11kV, LV under-built on 50kV, PILC cables, XLPE cables or conjoint PILC – XLPE cables. Approximate populations of various construction types are presented below...

Description	Length (km)	
	Overhead	Underground
LV Only	108.0	
LV Only Remote	19.4	
LV Only Roadside	121.8	
LV Only Roadside Remote	9.6	
LV Only Rugged	7.4	
LV Only Rugged Remote	2.8	
LV Under built	92.2	
LV Under built Remote	18.2	
LV Under built Roadside	116.8	
LV Under built Roadside Remote	22.0	
LV Only PILC		9.3
PILC Roadside		1.3
LV Only PVC/XLPE		151.4
LV Only PVC/XLPE Roadside		27.8
LV Conjoint PILC Roadside		0.1
LV Conjoint PVC/XLPE		5.4
LV Conjoint PVC/XLPE Roadside		2.1

2.2.6.4 Per substation basis

On a per substation basis the split of LV network is laid out in the following sections. Similar to the distribution network, customer density is a strong driver of viability and influences ENL's allocation of time, effort and funds.

Gisborne

Sub.	Line length (metres)	Customers	Customer density
Te Araroa Sub	136124	475	4
Ruatoria Sub	198416	769	4
TokomaruBay	196634	576	3
Tolaga Bay	191739	646	4
Kaiti	100498	3492	34
Carnarvon	53479	3936	74
Parkinson	30270	1899	63
Makaraka	157838	3249	21
Patutahi	290576	1425	5
Pehiri	151863	272	2
Ngatapa	128905	267	2
Puha	414552	1105	3
JNL	0	0	1
Matawhero Sub	29093	224	8
Port Sub	49625	1707	34
Totals	2,129,112	20,042	

Wairoa

Sub.	Line length (metres)	Customers	Customer density
Tuai	133995	372	3
Kiwi	504295	3361	7
Blacks Pad	94568	815	9
Waihi	0	0	0
Tahaenui	64364	274	5
Totals	797223	4,822	

LV Switchgear for control and protection of the LV underground network is generally housed in Transformer enclosures as an LV Frame, In Link boxes or as part of a Distribution box. For overhead installations the switchgear typically exists in the form of pole mounted fuses at transformer sites. The underground enclosures are installed with the LV reticulation usually at the subdivision development stage.

There are approximately 320 Linkbox enclosures and 350 LV Frames integrated with the LV Network.

ENL also has the following Distribution boxes as part of the LV Network...

Type	Number
Galv /concrete	652
In-ground pit	325
Large black plastic	414
Medium green shear	849
Small black plastic	823
Small fiberglass	187
Total	3250

2.2.7 Customer connection assets

The sharp end of ENL's business is the 24,864 consumer connections - this is what ENL gets paid for providing (via the five retailers who convey electricity over the network) - all of the "other assets" convey energy to these consumer connections, and essentially are a cost that has to be matched by the revenue derived from the consumer connections. These consumer connections generally involve assets ranging in size from a simple fuse on a pole or in a suburban distribution pillar to dedicated lines and transformer installations supplying single large consumers. Quantities of customer owned private line quantities are summarized as follows...

- 11kV Overhead lines 360km
- 11kV Underground Cables 2.78km
- 400V Overhead Lines 317km
- 400V Underground Cables 3.7km

In most cases the fuse forms the demarcation point between ENL's network and the consumers' assets (the "service main"), and this is usually located at or near the physical boundary of the consumers' property. However in some cases a single consumer is supplied by a length of line or cable (often on public land) configured as a spur off ENL's network which is referred to as a "service line" (noting that successive revisions of the Electricity Supply Regulations in the late 1970's and early 1980's confused the two definitions). In such cases ownership of the service line has been passed to consumers, who are now responsible for funding and maintaining its safety and connectively to ENL's network.

Type of service connection	Gisborne	Wairoa

1-phase	7622	804
2-phase	9187	3035
3-phase	3222	994
Total	20031	4833

2.2.8 Load control assets

ENL currently owns and operates the following three load control transmitter facilities for control of ripple relays...

- Valley Road – 11kV injection at 315 Hz (not in service).
- Makaraka – 50kV injection at 315Hz.
- Wairoa – 11kV injection at 1,250Hz.

Historically the majority of controllable load in the urban Gisborne area was controlled by a cascade pilot wire network consisting of 10 pilot feeders.

The traditional pilot wire system predominantly used in Gisborne until 1992 was inflexible and expensive compared to the load control system that uses ripple relays and is well established in the wider Gisborne area. ENL owns the signal receivers on installed on the Gisborne network.

As it became more difficult to effectively fault-find ENL has phased out the existing pilot system in favor of more extensive use of ripple relays. This system was migrated to small areas each controlled by ripple relays at strategic points throughout the city in 2002. Hence the small numbers of the remaining pilot wire system typically consist of 10 to 20 contactors activated by a ripple relay.

The Wairoa urban centre uses a pilot wire system with ripple relays deployed in the wider area. The customer relays are owned by the incumbent energy retailer. The retailer has decommissioned the load control relays used in Mahia.

The controllable capability of the system is shown in the following table...

Channel			Interruptible load (kW)
1	1	Te Araroa	300
2	2	Ruatoria	600

3	3	Tokomaru Bay	400
4	4	Tolaga Bay	500
5	5	Wainui/Whangara	700
6		Tamarau	1,000
7		Kaiti #1	900
8		Kaiti #2	600
9	6	Town	500
10		West End #1	1,100
11		West End #2	700
12	7	Te Hapara #1	600
13		Te Hapara #2	500
14		Matawhero/Makaraka	400
15		Whataupoko #1	500
16		Whataupoko #2	600
17		Mangapapa #1	900
18		Mangapapa #2	700
19		Westpark/Matokitoki	300
20	9	Patutahi/Waipaoa	400
21		Waimata	600
22		Muriwai/Te Arai	600
23	10	Pehiri	200
24	11	Ngatapa	200
25		Matawai	300
26	12	Puha	500
		Wairoa 00	381
		Wairoa 01	116
		Wairoa 02	327
		Wairoa 03	552
		Wairoa 04	508
		Wairoa 05 Night store	25
		Wairoa 06	511
		Wairoa 07	545
		Wairoa 08	519
		Wairoa 09	537

	Wairoa 16 Night store	48
	Wairoa 17	168
	Wairoa 18	179
	Wairoa 19	497
	Wairoa 30 Flood Pump	118
	Wairoa 31 Spa Pool	30
	Wairoa 32 Cold Store	60

2.2.9 Protection & control

2.2.9.1 Key protection systems

ENL's network protection includes the following broad classifications of assets...

- CB protection relays which have always included over-current, earth-fault, sensitive earth-fault and auto-reclose functions. More recent equipment also includes voltage, frequency, directional; distance and CB fail functionality in addition to the basic functions.
- Transformer and tap changer temperature sensors.
- Surge sensors
- Explosion vents.
- Oil level sensors.

There is now a mix of electro-mechanical, discrete component and microprocessor based equipment on ENL's network.

2.2.9.2 Voltage control equipment

Controls with dual transformer tap changers are configured in a master-follower arrangement at older substations and balancing load $I_{sin\theta}$ control algorithms are used for new installations. A range of electromechanical, solid state, and microprocessor based controls are used.

Controls are an area in which technology advances make such controls a viable option even for the smallest substations.

2.2.9.3 DC power supplies

Batteries, battery chargers, and battery monitors provide the DC supply systems for CB control and protection functions as follows...

- 110V DC supplies are primarily required for 50kV CB operation and in a number of substations are used for 11kV CB operation and protection.
- 24V DC supplies are typically used for SCADA RTU'S emergency lighting, protection and CB control at newer installations.
- The radio communication systems are typically supplied via 12DC systems.

2.2.10 SCADA & Communications

ENL uses SCADA for control and monitoring of zone substations and remote switching devices. Point of supply load control functions are also carried out using the SCADA.

2.2.10.1 Master station

ENL's SCADA master station is located at the head office in Carnarvon St and comprises an Abbey Systems dual master / backup master station configuration which was installed in 1999. There are 6 communication ports in use from the Master Station:

- Port 1 - Cable circuit (Gisborne city, 4 sites).
- Port 2 - UHF Radio repeater (Gisborne city, 6 sites).
- Port 3 - Makaretu circuit (Puha / Matawai area, 24 sites).
- Port 4 - Coast radio circuit (Tolaga – East Cape, 35 sites).
- Port 5 - Wairoa radio circuit (46 sites).
- Port 6 - Cable circuit (Gisborne city, 6 sites).

2.2.10.2 Remote stations

There are 19 Abbey Systems Full RTU installations and 102 Abbey Systems Topcat installations at remote control switches or monitoring and control sites, currently installed on the SCADA system.

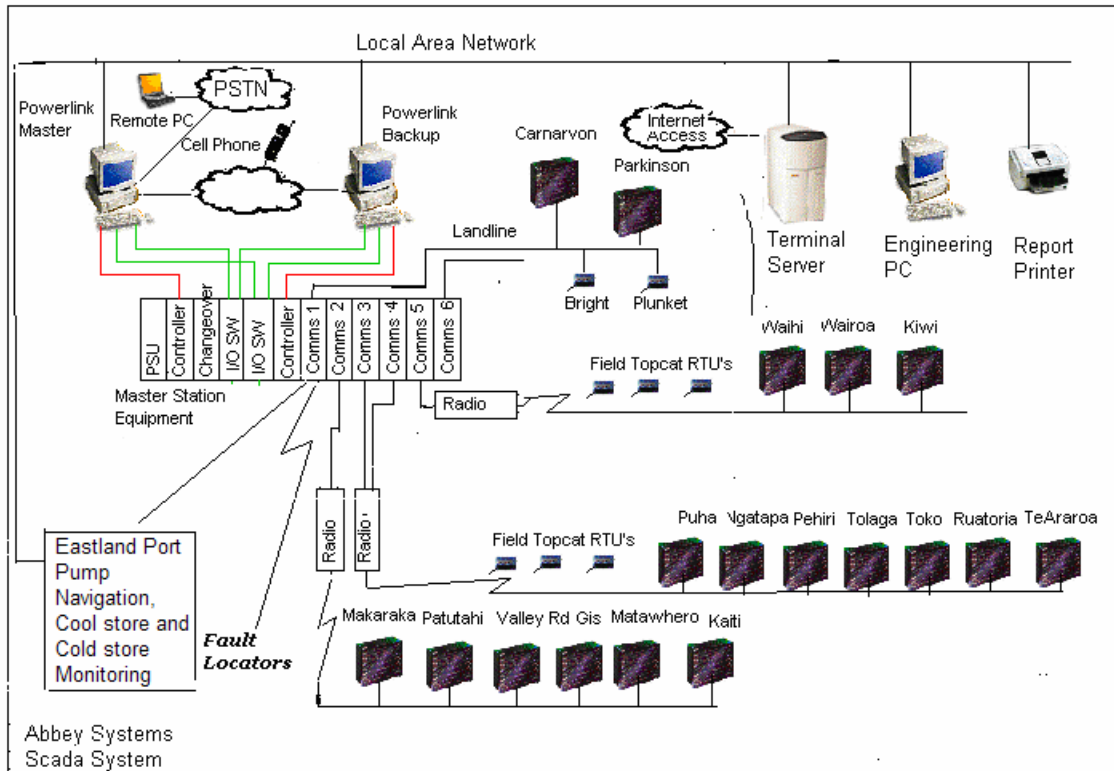

2.2.10.3 Communications links

ENL currently owns and operates the following communications links...

- Nine full duplex UHF communications channels linking the VHF voice repeaters and also providing for SCADA. These links operate in the 450-465MHz J-band.
- Six 1+1 links forming the main back bone of the system between Gisborne and Te Araroa which were installed in 1993.
- A further 2 links were installed in 2000 with new equipment from Gisborne via Whakapunaki to Kinikini.
- A 4RF Digital Link is installed between Whakapunaki and Arakihi to facilitate contingent rerouting.

- A 4RF Digital Link was installed from Carnarvon St to Makaretu in 2003 to provide additional lines enabling the number of RTU's on a single SCADA port to be reduced improving the poll duration to targeted levels.
- Six VHF and seven UHF point to multipoint repeaters are also used for SCADA communications to substations and field recloser sites. This equipment was installed between 1999 and 2001 and consists of a mix of new and reused equipment.
- Point to point link established in 2002 to provide SCADA coverage to the Waihi Power station a short UHF link.
- Fiber optic Communications cables were installed in 2005 between Carnarvon Street and Kaiti, Port, Parkinson, Makaraka, JNL, Matawhero substations. The cables provide SCADA, Telephone, Protection and IP services.
- A network of WiFi 2.4GHZ radios was deployed in 2005 to integrate EIL business to the ENL Scada system to provide monitoring of PLC controllers for access security, sewer-pumps, Navigation systems, Cranes and compressor cooling systems.

The existing voice communications system consists of eight VHF E-band 25W repeaters. Five of the repeaters are all coupled together via the second channel of the 1+1 UHF links between Gisborne and Te Araroa. One repeater operates from Carnarvon St primarily for coverage around ENL's offices. The remaining two repeaters are coupled to the UHF 1+1 system between Gisborne and Kinikini. Both networks are run coupled at the Carnarvon St Control room and have the ability to be decoupled when radio traffic is high. Each repeater can be remotely disconnected from the truck network in the event of a failure. In order to provide SCADA coverage to the Waihi Power station a short UHF point to point link established in 2002 is used.

A number of communications media and protocols are used to provide voice and data information for operation of the network. Systems include VHF Radio, UHF Radio and Cable. Protocols associated with data communication include Modbus, DNP3, Abbey Systems (HTLC) Sigtec and System DO.

Communications Overview

- UHF 4RF Digital Link
- UHF 1+1 Scada/RT
- UHF Scada
- VHF Scada
- Cable Scada

K VHF SCADA Repeater

K VHF RT Repeater

K Comm Port 1 Abbey Gable

K Comm Port 2 Abbey UHF

K Comm Port 3 Makerehu

K Comm Port 4 Abbey Coast

K Comm Port 5 Abbey Wharero

Wharero (Wharero) (K)

148 148 148 148 148

148 148 148 148 148

148 148 148 148 148

148 148 148 148 148

148 148 148 148 148

148 148 148 148 148

148 148 148 148 148

148 148 148 148 148

148 148 148 148 148

148 148 148 148 148

148 148 148 148 148

148 148 148 148 148

148 148 148 148 148

148 148 148 148 148

148 148 148 148 148

148 148 148 148 148

148 148 148 148 148

148 148 148 148 148

148 148 148 148 148

148 148 148 148 148

148 148 148 148 148

148 148 148 148 148

148 148 148 148 148

148 148 148 148 148

148 148 148 148 148

148 148 148 148 148

148 148 148 148 148

148 148 148 148 148

148 148 148 148 148

148 148 148 148 148

148 148 148 148 148

148 148 148 148 148

148 148 148 148 148

148 148 148 148 148

148 148 148 148 148

148 148 148 148 148

148 148 148 148 148

148 148 148 148 148

148 148 148 148 148

148 148 148 148 148

148 148 148 148 148

148 148 148 148 148

148 148 148 148 148

148 148 148 148 148

148 148 148 148 148

148 148 148 148 148

148 148 148 148 148

148 148 148 148 148

148 148 148 148 148

148 148 148 148 148

148 148 148 148 148

148 148 148 148 148

148 148 148 148 148

148 148 148 148 148

148 148 148 148 148

148 148 148 148 148

148 148 148 148 148

148 148 148 148 148

148 148 148 148 148

148 148 148 148 148

148 148 148 148 148

148 148 148 148 148

148 148 148 148 148

148 148 148 148 148

148 148 148 148 148

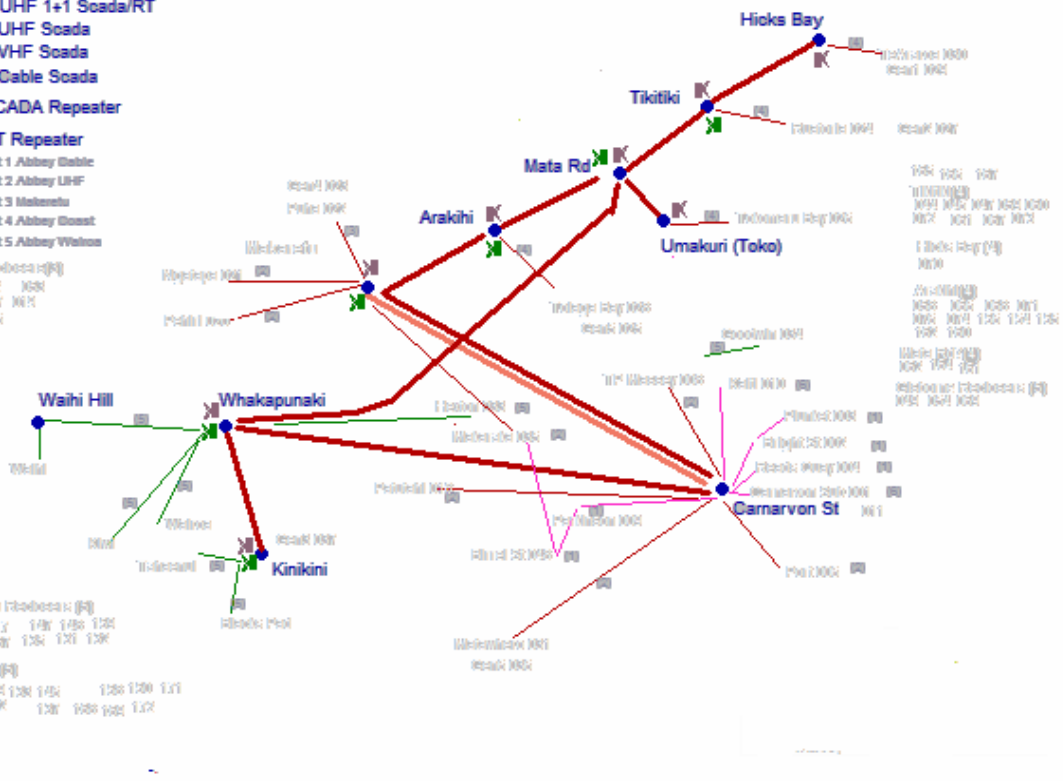

2.2.11 Other assets

2.2.11.1 Generators

ENL purchased 6 x 1.25MVA Diesel Generators in 2002 that supply at 11kV and include TOU metering. The units are capable of being relocated as required.

A 600kVA Diesel Generator was purchased in the 1990's. The unit is portable and generally the output is provided at 11kV to isolated sections of the network during fault or planned work events. The unit does not have synchronizing or metering capabilities.

ENL Purchased the 5MW Waihi hydro power station in 1999 which operates on run of river strategies and is embedded within the Wairoa GXP

ENL's hydro and diesel generation assets whilst operated in conjunction with the network are not network assets and financially are accounted for separately. Accordingly operational, maintenance and development plans for the hydro and diesel generation assets are not discussed in this AMP.

Small diesel Standby generators are installed at critical locations to ensure ENL's SCADA and Communications network can be sustained in contingent events. A 12kVA unit is installed at Carnarvon Street Substation and 5 x 5kVA units are located at Makaretu, Arakihi, Mata Rd, Whakapunaki, and Tikitiki radio repeater Sites respectively.

2.2.11.2 Software

ENL commissioned the Powerview GIS mapping System in 2002 which contains the network Line, cable, Distribution Substation, Switchgear and connection location, connectivity inspection and condition information.

ENL maintains network modeling design software including Load flow and protection coordination using the PSSU software package.

The Visim line design package was initially purchased from Foleys in 1997 and is used to validate Structure and line design. This software is used in conjunction with the AIME pole testing package.

2.3 Age & condition of assets by category

ENL approximates asset condition by age for asset categories with large populations and similar performance characteristics. The life cycle activities described in Section 5 of this AMP qualify the relevance of the age/condition approximation and ultimately determine the rate at which each asset category ages.

2.3.1 Bulk supply assets

The Bulk supply assets described in Section 2.2 of this plan are owned and operated by Transpower in accordance with their asset management policies and procedures. In general the age and condition and performance of these assets is in line with ENL's expectations.

2.3.2 Sub-transmission Lines

The age of sub-transmission poles is as follows...

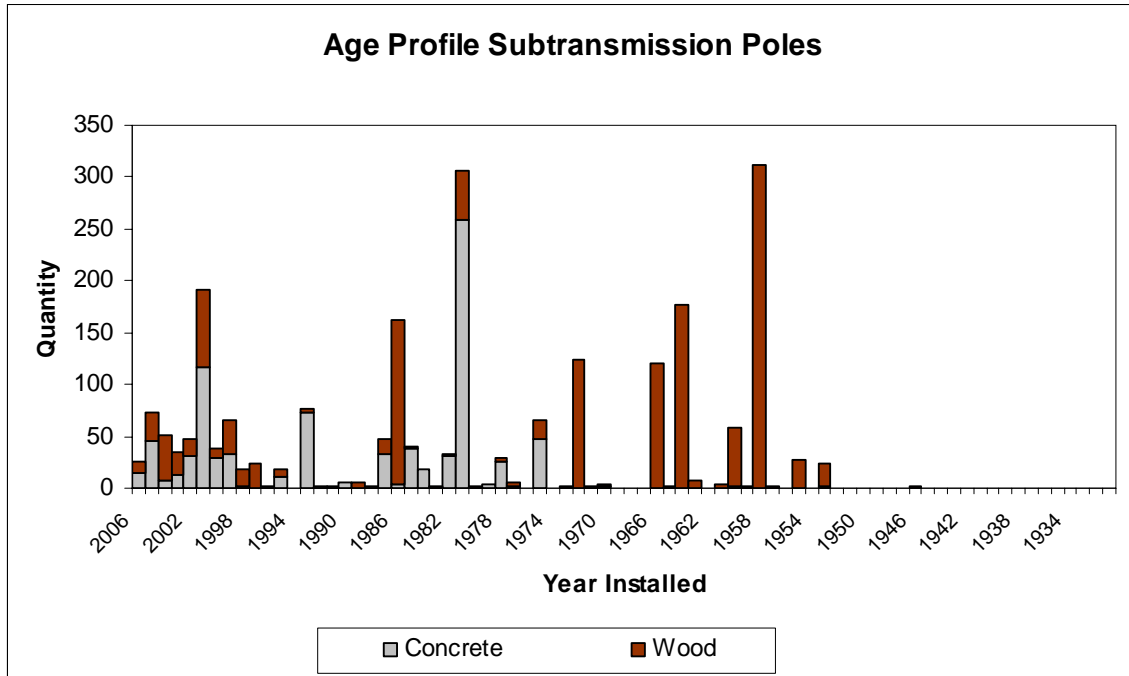

The age of sub-transmission conductor is as follows...

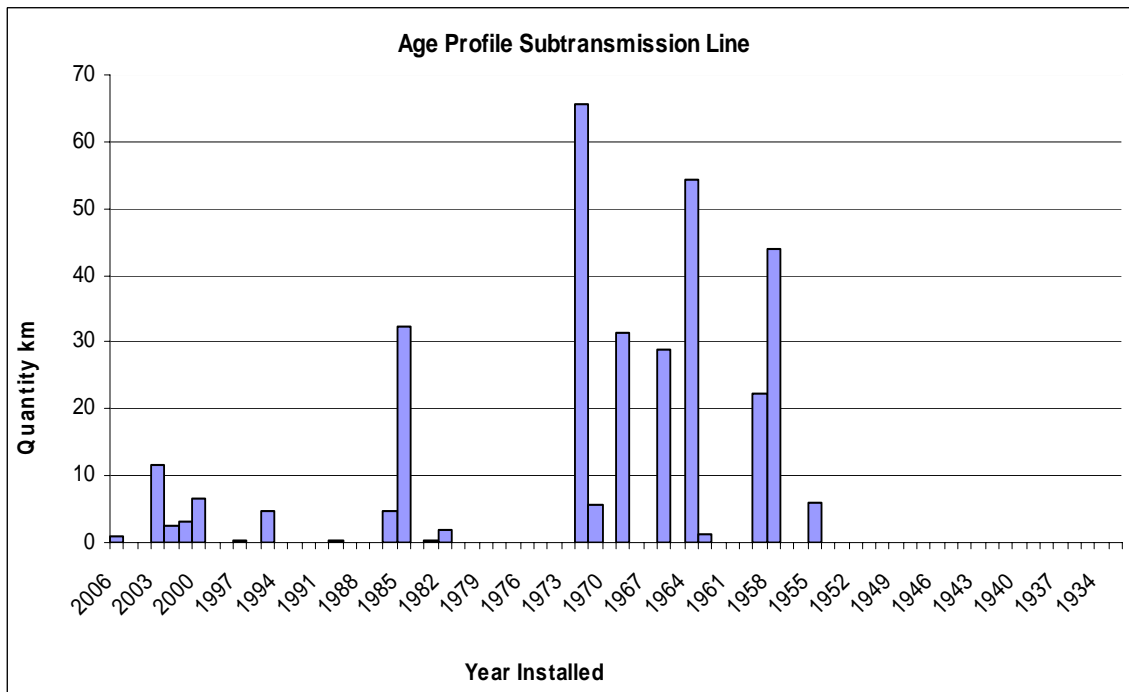

The high growth period between 2003 and 2005 is associated with urban reinforcement.

Conductor is lasting longer than poles in terms of condition however Growth and Security triggers have prompted conductor size increases. Poles are well into their age replacement period while conductor is predominantly showing the initial installation pattern. Note some conductor is second hand, explaining the less smooth and more spread installation profile.

As the assets are considered critical replacement is planned before the in service failure rate becomes high.

The poles in replacement zone are wooden.

The replacement rate for poles from 1988 indicates the replacement cycle is already in progress.

Despite some conductor being very old, there are no identified corrosion or strength issues predicted. Some vibration damage has been identified during inspections. Conductor and bindings are repaired and vibration clamps are fitted as identified. Vibration damage is initially picked up by visual inspection of binders.

Glazing is failing on OB insulations. This is believed to be the result of age, agricultural chemical and sun damage. It results in TV interference complaints, which we are obligated to repair in an acceptable time frame. This is more expensive than a coordinating replacement with other planned work. Discharge detection cameras are also used to identify problem sites with all 50kV lines checked 2 yearly. Approximately 5 sites p.a. are identified and corrected.

There is known problem of pole fires caused by failures NGK 10 skirt insulators. These are only rated at 45kV and problem is more prevalent in areas close to the coast. It is estimated that approximately 500 insulators of this type are still located in the problem area. Between 2000 and 2003 approximately 20 insulators p.a. were replaced. No allowance is made for replacement until problem sites are identified.

There are approximately 750 strings of blue and brown ceramic insulators that are in the order of 80 years old. These insulators were received in 1960, 2nd hand from NZED. Industry experience indicates that we cannot expect much more life out of this type of insulator.

The original suspension strings on the Mahia Line were discovered to have severe wearing on the top hook (40% worn through) in 2001. They had also been stressed through incorrect operating voltage (corrected in 2000). A majority of these insulators were replaced between 2001 and 2003. The Mahia line also has no amour rods fitted to protect the conductor which may shorten conductor life. Remaining problems will be addressed as identified.

All other hardware is believed to be in adequate condition to survive the pole.

2.3.3 Distribution Lines and Cables

The age of 11kV poles is as follows...

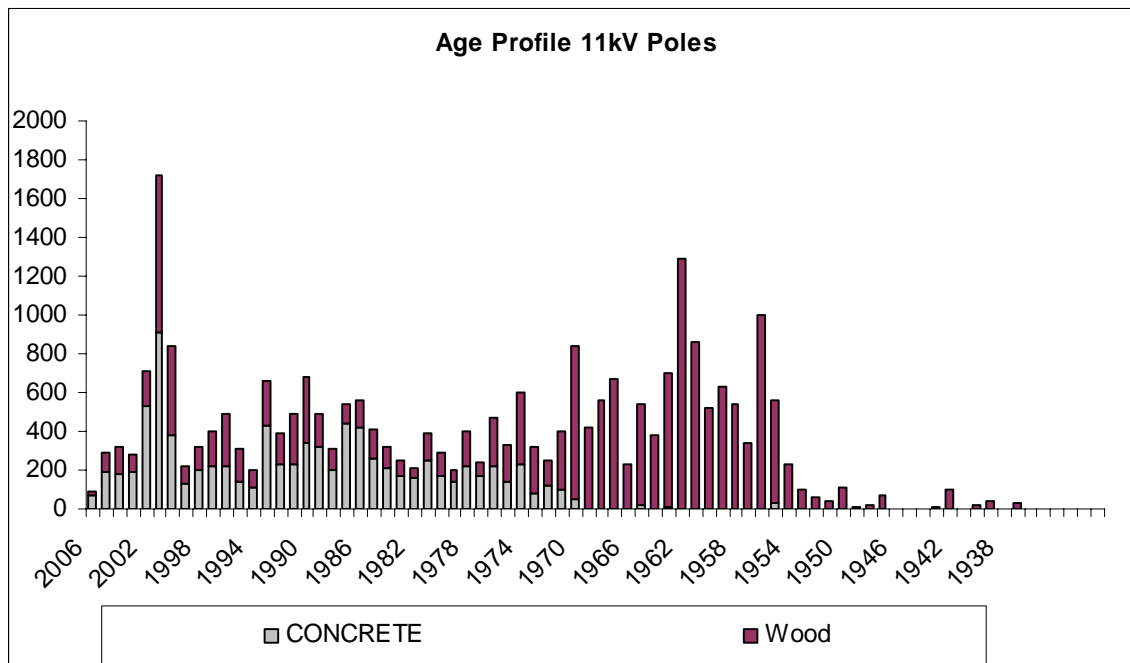

The age of 11kV conductor is as follows...

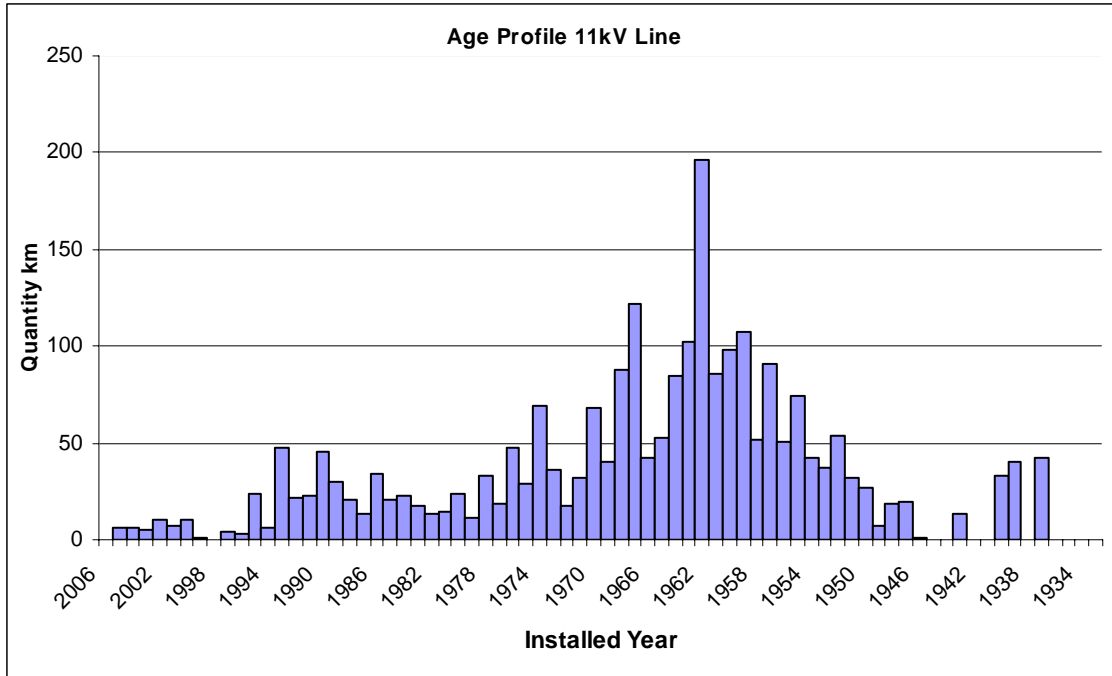

The profiles indicate that poles are well into a replacement program. The nominal 60-year life represents the end of the age failure period, which is more applicable to wooden poles, not the start.

The conductor population is older than the pole population, which is reflected in condition.

The installed 11 kV conductors consist of aluminum (22%), steel (27%) and copper (51%) construction.

Approximately 30% of conductor is in the failure portion of the life cycle.

78% of the conductor used is copper or steel. The conductor size is typically small due to lack of historical capacity upgrades.

There is 661km of galvanised steel conductor on the network. Approximately 130km is rusting badly to the point where regular breakages are occurring. Currently repair costs are below the replacement threshold however indications this conductor requires replacement over the next 10 years.

The pole renewal program has uncovered a high incidence of broken conductor strands under bindings due to fatigue on light copper lines. This is also evident in the fault statistics.

The age of 11kV cable is as follows...

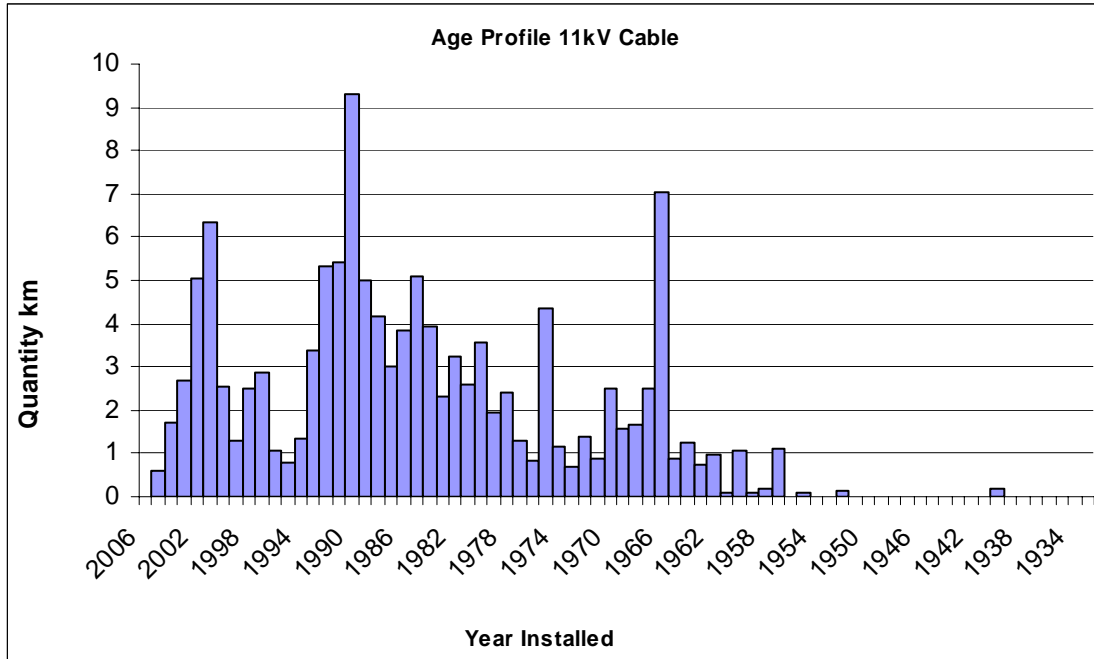

Due to sample size of cables and the relative new age of the asset the profile is showing a installation patterns rather than renewal. In general capacity upgrades are sufficient to mitigate age replacement

2.3.4 Zone Substation Transformers

The age of Zone Substation Transformers is tabulated as follows

Zone Substation Transformers				
Location	Type	KVA	Manufacture date	
01 Te Araroa Sub	50/11 - 3 Phase	2500	1/01/1998	
02 Ruatoria Sub	50/11 - 3 Phase	5000	1/01/1997	
03 Tokomaru Bay Sub	50/11 - 3 Phase	2500	8/08/1997	
04 Tolaga Bay Sub	50/11 - 1 Phase	1667	1/01/1965	
04 Tolaga Bay Sub	50/11 - 1 Phase	1667	1/01/1965	
04 Tolaga Bay Sub	50/11 - 1 Phase	1667	1/01/1965	
05 Kaiti Sub	50/11 - 3 Phase	12500	1/01/1987	
06 Carnarvon Sub	50/11 - 3 Phase	12500	1/01/2003	
06 Carnarvon Sub	50/11 - 3 Phase	12750	1/01/1995	
07 Parkinson Sub	50/11 - 3 Phase	12500	1/01/1986	
07 Parkinson Sub	50/11 - 3 Phase O/Hauled 2004	12500	1/01/1971	

08 Makaraka Sub	50/11 - 3 Phase	12750	1/01/2001
09 Patutahi Sub	50/11 - 1 Phase	1667	1/01/1948
09 Patutahi Sub	50/11 - 1 Phase	1667	1/01/1948
09 Patutahi Sub	50/11 - 1 Phase	1667	1/01/1948
09 Patutahi Sub	50/11 - 1 Phase	1667	1/01/1941
09 Patutahi Sub	50/11 - 1 Phase	1667	1/01/1941
09 Patutahi Sub	50/11 - 1 Phase	1667	1/01/1941
10 Pehiri Sub	50/11 - 3 Phase	2500	8/07/1996
11 Ngatapa Sub	50/11 - 3 Phase	500	1/01/1930
11 Ngatapa Sub	50/11 - 3 Phase	500	1/01/1930
12 Puha Sub	50/11 - 1 Phase	1667	1/01/1949
12 Puha Sub	50/11 - 1 Phase	1667	1/01/1949
12 Puha Sub	50/11 - 1 Phase	1667	1/01/1949
14 Matawhero Sub	50/11 - 3 Phase	5000	1/01/2001
14 Matawhero Sub	50/11 - 3 Phase	5000	14/08/2000
15 Port Sub	50/11 - 3 Phase	12750	1/01/2001
31 TPWairoa Sub	33/11 - 3 Phase	2500	1/01/2000
32 Kiwi Sub	50/11 - 3 Phase	6300	1/01/1983
33 Blacks Pad Sub	33/11 - 3 Phase	1500	14/05/2000
34 Tahaenui Sub	33/11 - 3 Phase	1500	14/05/2000
35 Waihi Sub	50/11 - 3 Phase	6300	1/01/1983

The general expectation for transformer life is 60 years if the load has generally been low and overhaul work has been undertaken at 30 years alternatively 45 year life is expected if no life extension work has been carried out.

Zone transformers are considered critical equipment as the lead-time for replacement or repair can be months and they are generally too expensive to warrant holding spares. For this reason it is important that they are replaced before there is any risk of in-service failure

Tap changers are the weak link in transformer reliability. ENL carries a spare OLTC unit for its IMP transformers, which have proven to be less reliable if full rebuild isn't undertaken on delivery to ensure quality of fitting. A range of other spares such as bushings are also carried.

There is a surplus of single phase units currently in service for the single phase transformer banks. Therefore a number of units can be allowed to fail in service before total replacement is required.

Dual transformer installations can also avoid early replacement due to the higher security provision.

Known performance issues and past events that have limited transformer life include the following: -

Ngatapa

The transformers at this substation are the oldest units still in service and test results indicate replacement is due.

Patutahi

Blue phase transformer on T2 bank has a low test, but it is to be removed from service if it fails.

Puha

The alternative to defer T1 replacement is to install a new transformer at Ngatapa, improving the security support to Puha and reducing the area affected in the event of an outage

Tolaga

The T1 transformer bank has had a major overhaul in 1996.

2.3.5 Circuit Breakers

The age of Circuit Breakers is as follows...

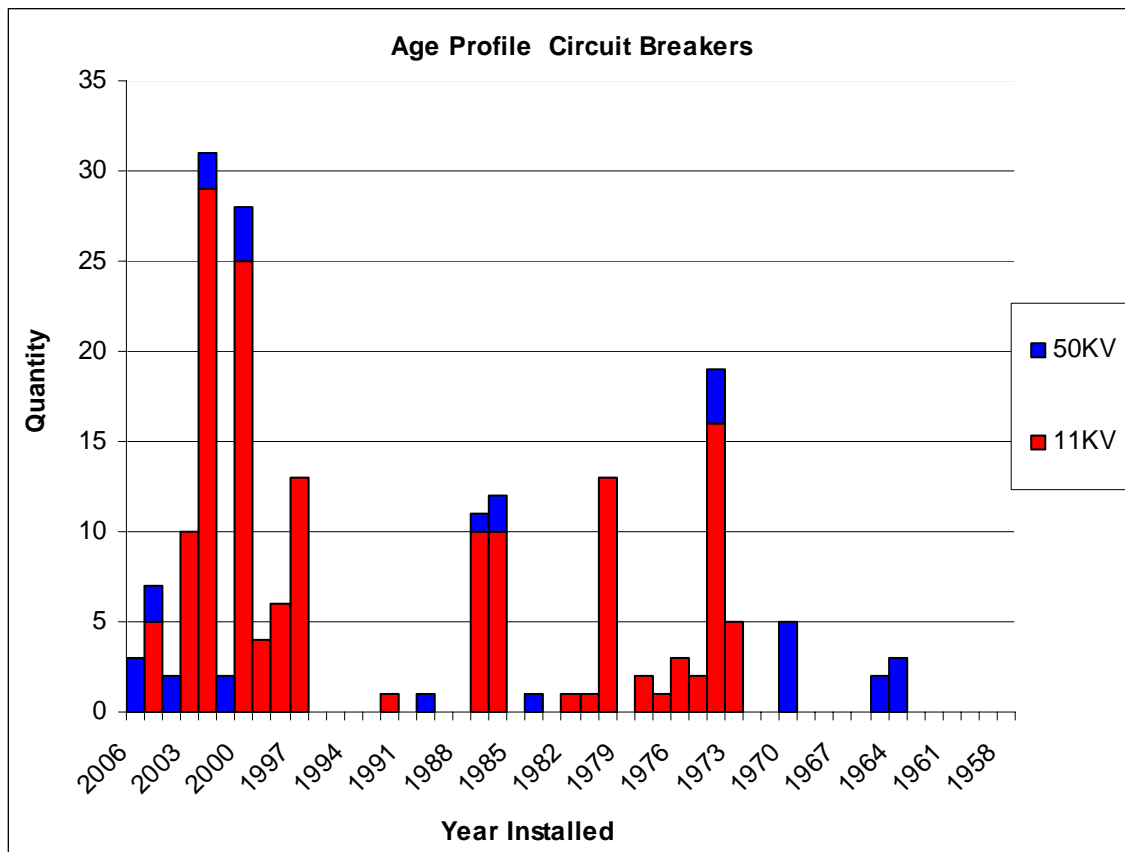

The data includes all 50kV, 11kV, indoor and pole mounted equipment located within Zone Substations and installed in the wider Network. There is insufficient population of any single type to draw conclusions. The period from 1999 to 2004 reflects rural CB installation and Zone substation upgrading programs.

11kV switchboard reliability is critical and therefore early replacement is desirable.

The 50kV Bulk Oil CB's were obtained 2nd hand from Transpower and refurbished. Prior to installation they were 40 to 50 years old and based on current assessment replacement of these units will be necessary within the planning period as the mechanisms become unreliable and the insulation of the equipment begins to fail. The refurbished units are used in locations where the peak load does not exceed 10MW, fault levels are low to ensure maximum life extensions are obtained, and slow clearing times are acceptable.

2.3.6 Pole Mounted Isolation Equipment

The age of 11kV fuses is as follows...

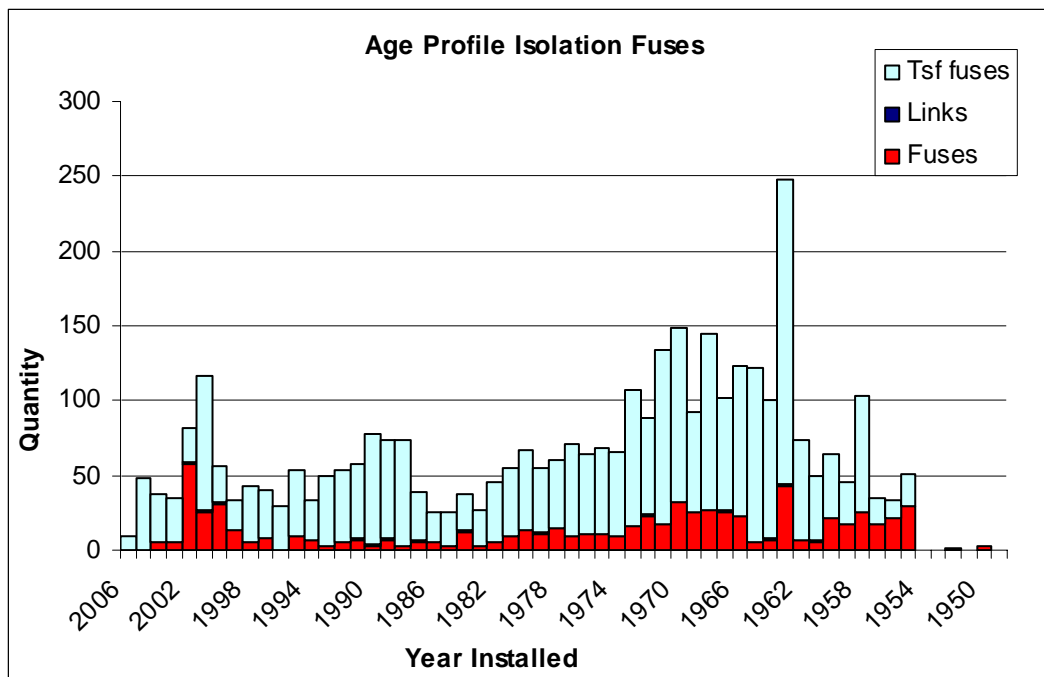

The transformer fuses are indicating a pattern which is into a replacement cycle which generally coincides with transformer replacement.

The age of 11kV pole mounted Switches is as follows...

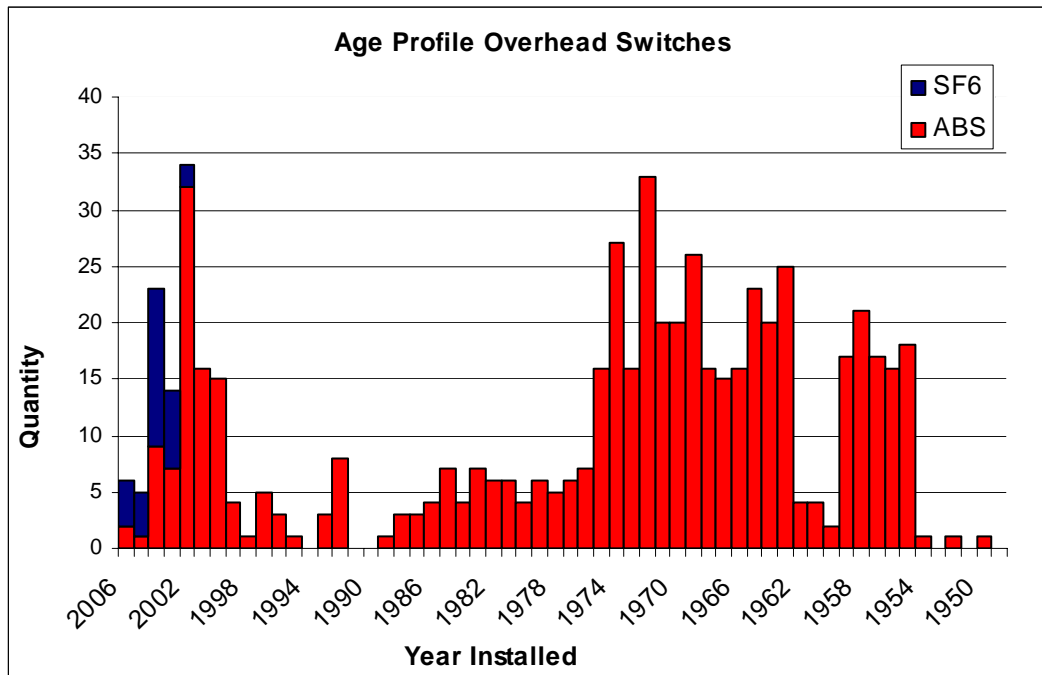

The ABS units have in general been installed during construction with minimal attention or operational/use since. The long service life with minimum maintenance is leading to high probability of failure if operated.

The total average installed age for 50kV switch types is 16 years. There are 78 switches on ENL's network. 5 are motorised.

50kV ABS's have been well maintained and are relatively new. Therefore they are expected to deliver a service life equivalent to the ODV life of 35 years despite criticality.

Quadrant ABS's have been identified by the Electrical Safety Service as a compliance concern. The proportion of 200Amp Quadrant wire operated Air break switches installed on the network is 65% exact quantities have not been captured. These switches have a priority for replacement. These ABS's are inadequate for the following reasons...

- Phase separation is too close. ENL's standard for phase separation is 900mm in order to reduce risk of arc over.

- Open contact spacing is too close to comply with minimum standards for air isolation. The requirement is a gap of 150mm minimum.
- The switches are not rated to break load (10A maximum). Controllers and operators risk making errors in identifying this limitation as it is not identified on site or on the system diagram.
- They are wire operated. The wire passes through live conductors without adequate clearance.
- The handle mechanism is not optimum for clean, swift, positive action.
- Earthing and isolation is inadequate.

Earthing and earth-mat condition is assessed as part of transformer earth inspection programs. (Refer Transformer section.)

2.3.7 Switchgear Ground Mounted

The age of 11kV Ground Mounted switches is as follows...

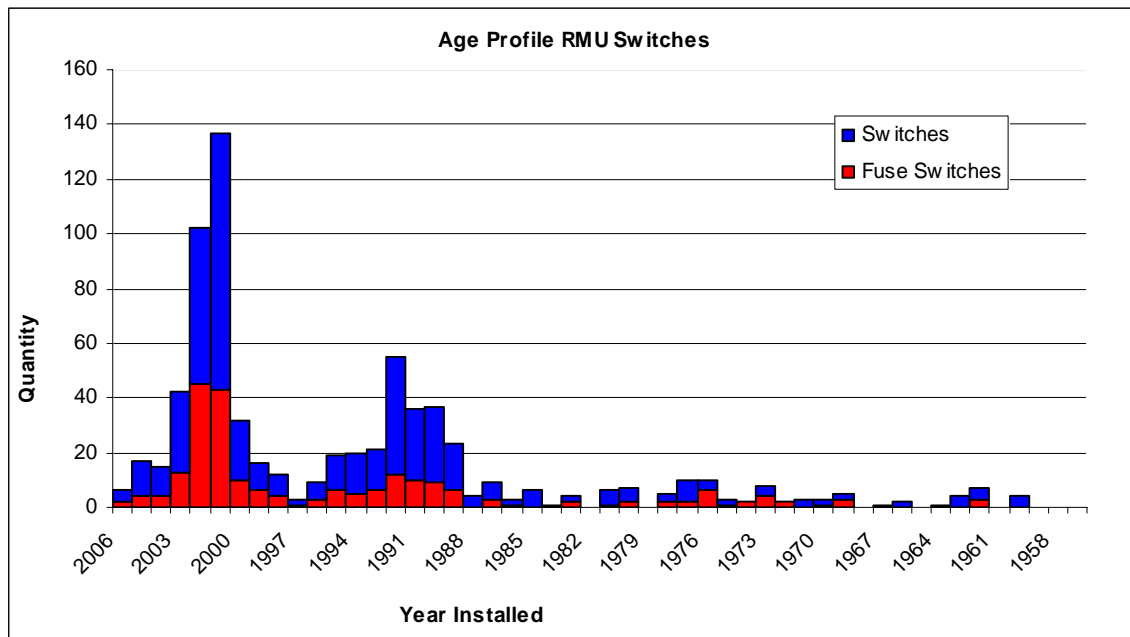

The quantities are based on individual switching units as opposed to complete assets containing multiple switching units.

The design deficiencies in older units have largely been eliminated by upgrades.

The population is relatively young largely due to early replacement due to older designs not meeting the necessary safety, performance and reliability requirements. These types included Magnefix, Rotary 'RTE' and series 1 Andelect units.

Installation quantities are generally dependent on other work such as under-ground reticulation or installation of new large transformers.

2.3.8 Distribution substations

The age of transformers rated at less than 100kVA is as follows...

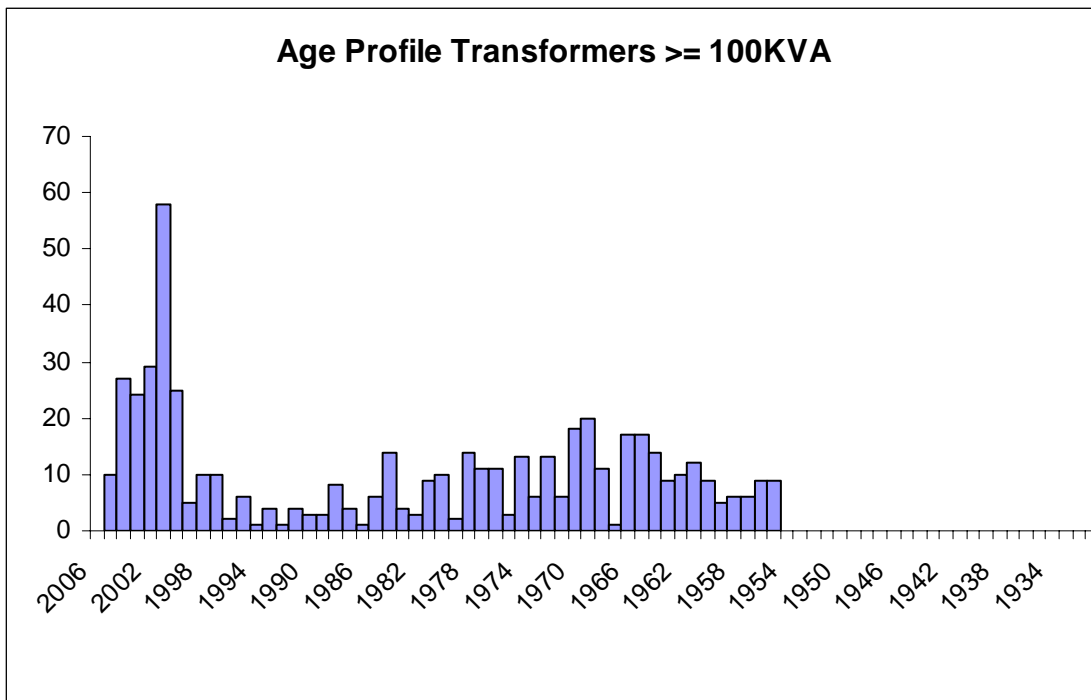

The age of transformers rated at 100kVA or greater is as follows...

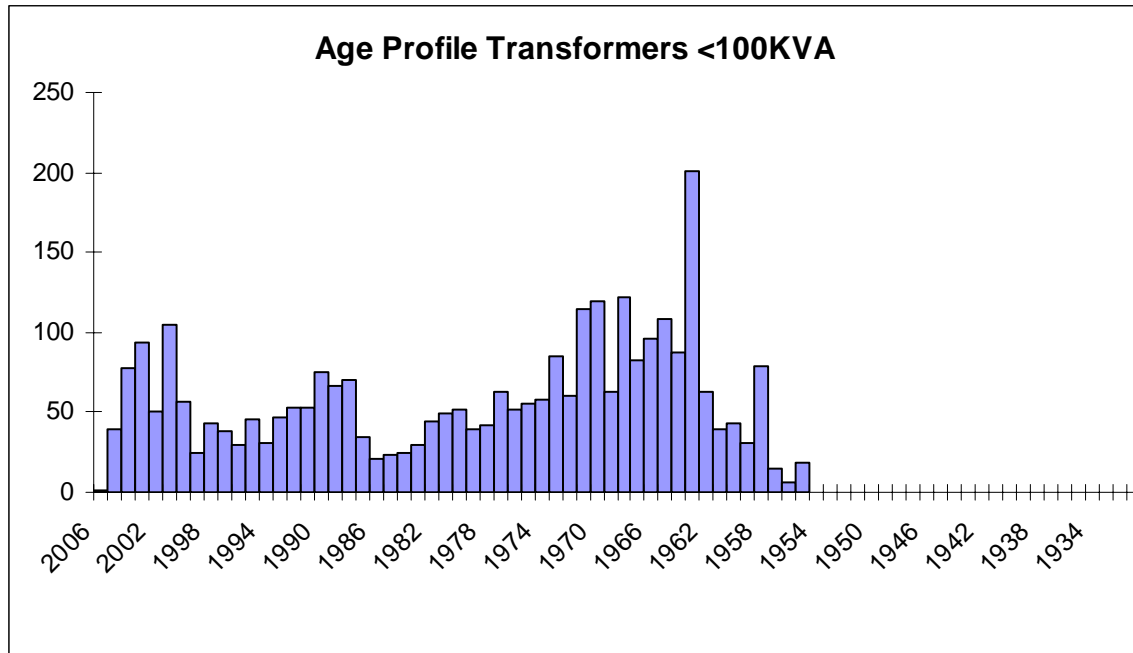

Transformers have a reasonably fast roll-off in survival spanning a 5-10 year period indicating sudden total failure mechanisms (e.g. tank rusting through)

A large installation of 200 small transformers remains installed in 1962. This peak is reducing as replacement continues.

Large transformers ($\geq 100\text{kVA}$) have an even installation profile. On average 12 were installed per year from 1960-1985, and 5/yr after 1985- 2000.

The Compliance program in 2000 eliminated the majority of the older group of pole mounted 250kVA units.

Transformers have been in a replacement cycle since 1988 at an average rate of around 60/yr.

Residual survival is considered negligible as it is only evident in large transformers which reflects the past maintenance attention they have received.

Ground-mount multi-fin transformers have been identified through inspections, to have rust issues and are developing leaks around the fins.

Failure analysis shows that the predominant cause of in service failure is tank life being reduced by rust. Re-tanking or repainting is not economic as a standalone action.

Older transformers with conductor leads through the bushings are failing as the conductor integrity deteriorates. The use of thicker PVC covered leads in past refurbishment and elimination of old transformers with downwards facing HT bushing will overcome this problem.

2.3.9 LV network

The age profile of LV poles is as follows...

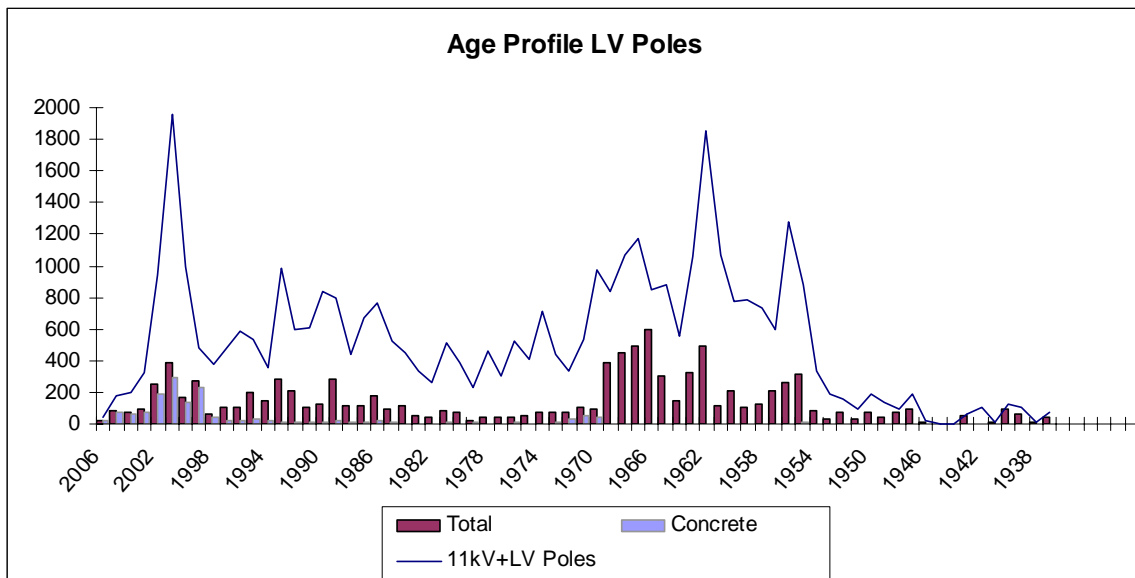

The age of LV conductor is as follows...

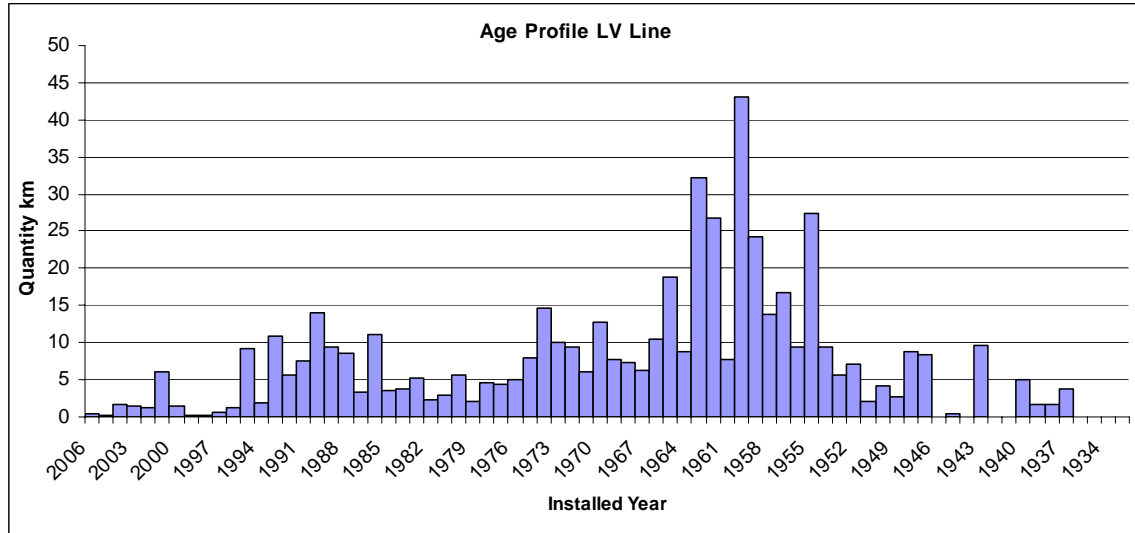

The LV overhead network generally is below design standards in terms of conductor size and length of circuit. This is visibly evident and likely to be the main contributor to a relatively high loss factor of on the network.

This low standard of LV construction has arisen due to a policy of not upgrading capacity unless age replacement is required. The historical reluctance to avoid capital renewal unless coordinated with under-grounding activity has also contributed. However it is a valid business strategy to trade off capital expenditure for increased losses but this becomes sub optimal in the long term. In urban networks where annual load growth in domestic installations is approximately 1%, the 20% security capacity contingency for overhead lines will be consumed in 20 years.

Conductor tends to be replaced far sooner than poles due to capacity upgrades.

Poles tend to be left until in-service failure or need for replacement associated with new connections or conductor upgrade.

The low pole installation in recent years has some correlation with under-grounding and use of 11kV under building.

Average span in urban area very short at 30m allowing more lea-way in deterioration before design criteria is compromised.

The main performance issues are related to age or condition and minimal maintenance practices. These issues include...

- Failing connectors causing conductor burning
- Breaking conductor
- Stretched and sagging conductor vulnerable to wire wraps and being caught by high vehicle loads

LV overhead lines are managed in a reactive mode when fuses overload and voltage complaints are received. LV conductor is fused to full duty rating. Often during faults this rating is exceeded for short periods, particularly on overhead open lines. Where this has occurred regularly there is evidence of conductor life being shortened due to annealing of HD Cu., i.e. loss of tensile strength resulting in breakages.

The age of LV cable is as follows...

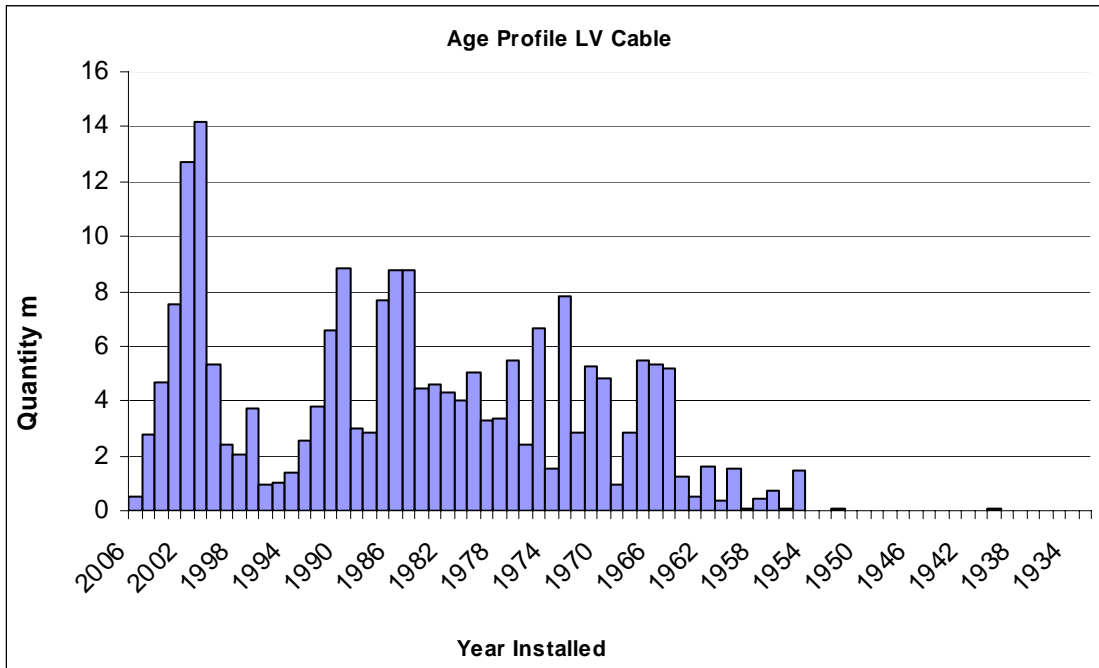

The cable installation rate shows a strong correlation with reduction in overhead line installation. Minimal replacement levels are evident but the age profile is driven more by capacity upgrade.

Generally transformers overload before cables and this is allowing issues to be overcome through increasing transformer density thus reducing LV run lengths. This approach will be adequate until transformer capacity is not needed for the load density it is more economic to re-conductor.

The average age of LV switches is as follows...

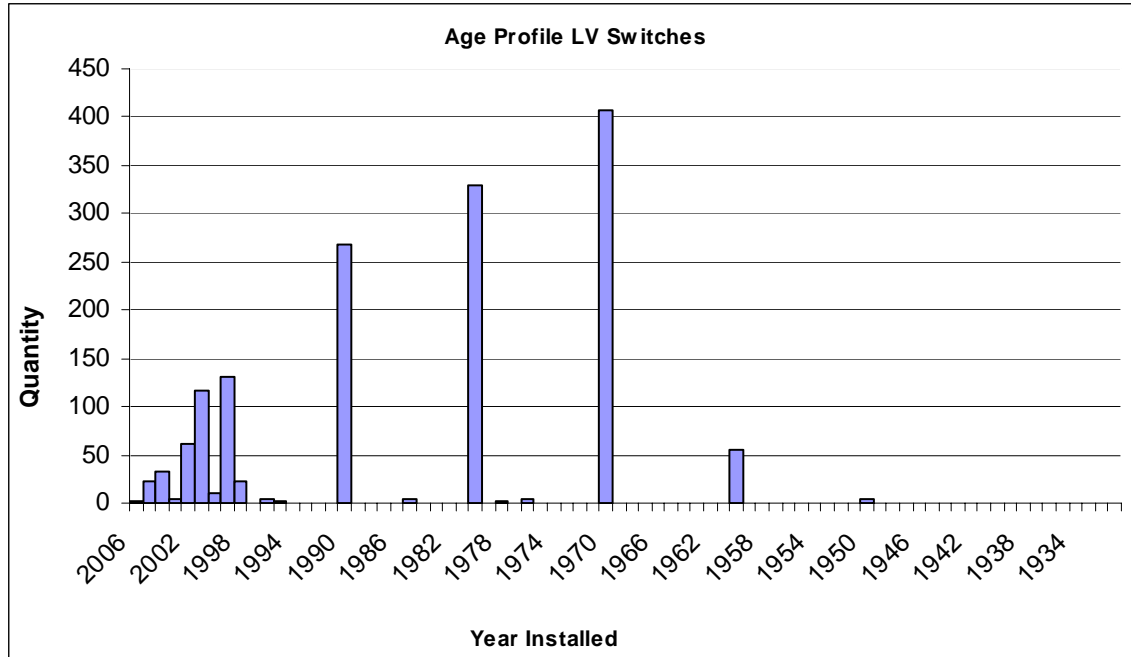

The dataset for LV switchgear including Transformer Frames, Link boxes and Distribution Boxes shows an incomplete pattern and approximate age as past documentation was not considered necessary. This equipment has a relatively young average age because its installation is associated with cables and ground mounting transformers. Therefore it has to be aged to the point where survival can be accurately assessed. Safety standards and performance of early installations is driving replacement. Most of this is undertaken in conjunction with other work such as transformer renewal.

2.3.10 Consumer connection assets

The age of consumer connections is as follows...

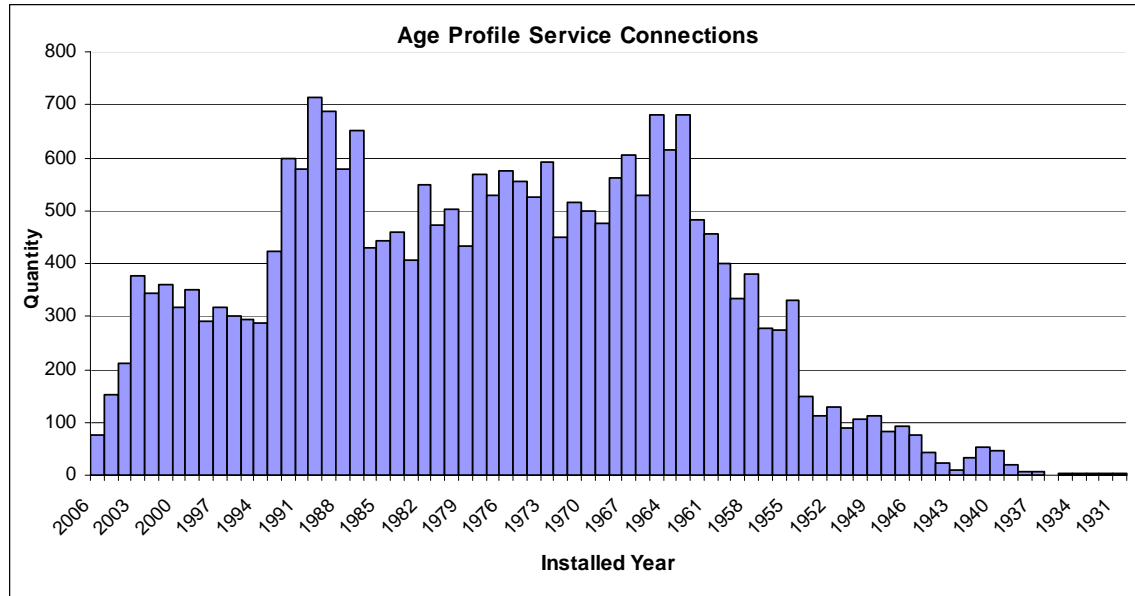

Failure of service fuses and connectors are the main faults. No preventive replacement programs are undertaken due to difficulty in predicting aging as this is dependent on loading conditions.

Approximately 25% of fuse bases require replacement when the fuse needs replacing. This is caused by burning on the terminal of loose jumper connections or corrosion. The problem is related to quality of the product and installation.

Service failures are treated as non-critical because they affect only one connection.

In some areas of the network service fuses are housed in metal clad meter boxes on the property boundary. As meter boxes they are owned by Contact Energy. Many of these boxes are damaged and in an unsafe state. ENL is removing its equipment from the meter boxes and relocating into new service fuse boxes. There is a similar issue with sun damaged fiberglass service fuse boxes.

Voltage drop in the customers' service main is the main reason for poor performance. ENL has not actively managed this in the past as it generally only affects the service of the consumer responsible for it. The higher losses however do reflect into the costs of the network and are ultimately shared by all customers.

Poor power factor also affects service connection performance driving the need to invest in transmission capacity. Offending installations will be notified to owners and failure to correct issues will result in penalty charges generally by way of increased kVA assessments.

Harmonic generation will be handled via penalty charging where it only affects ENL equipment. If it affects other consumers then disconnection and compensation to those consumers will be enforced.

2.3.11 Load control assets

Approximate numbers of remote load control devices are...

Description	Number
Ripple relays installed in Gisborne between 1990 and 2004.	8,875
Pilot-wire controlled loads in Gisborne.	4,755
TrustPower-owned installations in Wairoa.	Approx. 2,000
Total	

The Wairoa system operates at 1250 Hz, which is subject to high signal attenuation potentially resulting in unreliable control. As a result of this unpredictability TrustPower have removed the ripple control system in Mahia further reducing the effectiveness of the load control system for demand control of the Wairoa GXP.

The Gisborne frequency injection plant operates at 317HZ and signal attenuation issues at this frequency have proven to be less common.

As the age of the Injection plants increases the frequency of breakdown has increased. Performance of the Gisborne plant will be affected by the transformer upgrade project at the Gisborne GXP. To overcome the capacity increase required a new Injection transmitter facility will be required with a higher capacity rating.

The age profile of ENL's relays averages 12 years due to the recent replacement of the pilot wire contactors with ripple relays in the Gisborne city. Renewal programs for ripple relays are reactive in nature and are triggered by failure of the units to operate.

2.3.12 Protection & control

The protection and control equipment used predominantly at Zone Substation sites is varied in terms of functionality and performance characteristics for this reason condition and performance are assessed on a case by case basis. Due to the small population and variety of systems used age analysis provides an indication of the

appropriateness of technologies to provide the desired performance rather than condition.

2.3.12.1 Key protection systems

Protection equipment was traditionally expected to last the life of the device it protected. However newer electronic equipment is unlikely to perform adequately after 10 to 15 years. This equipment is required to co-ordinate across the network and therefore must maintain compatibility with ENL's and Transpower's latest technology. Generally technology upgrade is required before renewal.

Multilin 750/760 Protection relays have a history of issues relating to both firmware and circuitry defects. These defects have been corrected as solutions are identified. The solid-state relays at Kiwi, Kaiti and Parkinson Street substations have setting switches that have caused miss-operation.

The electro mechanical protection relays used at Carnarvon Street substation have been found to drift from setting values which is typical for equipment of this age. The Earth fault settings are inverse-time and do not coordinate well with down stream protection equipment.

2.3.12.2 Voltage control equipment

Tap change control relays provided by IMP with earlier transformer purchases have proved unreliable requiring 2 or 3 recalibrations or component replacements per year. Failure of the controls causes deviation from required voltage delivery parameters and in rare cases tripping of the transformers.

Older voltage regulators are currently fitted with mercury filled switch mechanisms. Replacement with PLC controls is planned when the existing units show signs of miss-operation due to mechanical wear.

2.3.12.3 DC power supplies

The DC power supplies have been progressively replaced from 1999 as older charges have become noisy and unstable. The equipment has an average age of 7 years

24 and 12 volt battery banks are generally less than 5 years old as renewal is more economic than regular testing due to the distances to sites. The condition of batteries installed in pole mounted automation installations deteriorates at a greater rate due to summer temperatures.

110V Battery banks are replaced at intervals of 6 to 10 years depending on condition testing hence the age of these installations averages around 8 years.

2.3.13 SCADA & Comms

As the Abbey Systems SCADA system was purchased in 1999 the average age of the components is approximately 4 years. The communications systems in place at the time of the SCADA system purchase were re-used for the new system.

2.3.13.1 Master station

SCADA systems have an ODV life of 15 years however as equipment ages beyond 10 years support becomes expensive and replacement technology becomes attractive.

Replacement systems generally cost less, are smarter, less proprietary, etc. Like other computer based systems replacement is frequent and continual.

2.3.13.2 Remote stations

To maintain functionality and compatibility with master station functionality the age of RTU's follows a similar pattern to the master station equipment influenced only by new rural automation sites.

2.3.13.3 Communications links

The age of communications equipment is tabulated as follows...

Repeater (Multipoint)	Description	Manufacture/ Install date
Whakapunaki	VHF Voice + Sys DO	1987/1990
Whakapunaki	VHF Abbey	2000/2000
Kinikini	VHF Voice + Sys DO	1987/1990
Kinikini	VHF Abbey	1993/2000
Carnarvon St	VHF Voice	1990/1990
Carnarvon St	UHF Abbey	1999/1999
Umakuri (Tokomaru)	VHF Voice	1993/1993
Umakuri	UHF Abbey (Tokomaru)	2001/2001
Tikitiki	UHF Abbey (Ruatoria)	2001/2001

Repeater (Multipoint)	Description	Manufacture/ Install date
Tikitiki	VHF Voice	1993/1993
Tikitiki	VHF Abbey	2002/2002
Hicks Bay Hill	UHF Abbey (TeAraroa)	2001/2001
Mata Rd	VHF Voice	1993/1993
Mata Rd	VHF Abbey	1993/2000
Makaretu	VHF Abbey	1993/2000
Makaretu	VHF Voice	1993/1993
Makaretu	UHF Abbey (Puha)	2001/2001
Makaretu	UHF Abbey (Ngatapa)	2001/2001
Arakihi	VHF Voice	1993/1993
Arakihi	UHF Abbey (Tolaga)	2001/2001
Arakihi	VHF Abbey	2001/2001
Waihi Stn on hill	VHF Abbey	2001/2001

Link (point to point)	Type	Manufacture Date
Gisborne - Makaretu	UHF 1+1 Data Voice	1993
Gisborne - Makaretu	4RF Digital Link	2003
Makaretu - Arakihi	UHF 1+1 Data Voice	1993
Arakihi – Mata Rd	UHF 1+1 Data Voice	1993
Mata Rd – Umakuri	UHF 1+1 Data Voice	1995
Mata Rd – Tikitiki	UHF 1+1 Data Voice	1993
Tikitiki – Hicks Bay Hill	UHF 1+1 Data Voice	1993
Gisborne - Whakapunaki	UHF 1+1 Data Voice	2000
Whakapunaki – Kini Kini	UHF 1+1 Data Voice	2000
Whakapunaki - Arakihi	UHF 1+1 Data Voice	2001
Waihi Power Station- Waihi Hill	UHF Data	2002

Communications cable (Note Significant circuits only)	Installed Date	
Carnarvon St - Gisborne	1987	
Gisborne - Kaiti	1986	
Carnarvon St - Makaraka	1986	
Carnarvon St – Bright St/ Plunket	1986	
Carnarvon St Reads Quay	1986	
Carnarvon St – Parkinson St / Birrel St	1986	
Fibre Optic Circuits		
Makaraka - Parkinson St	2005	
Parkinson St - JNL	2005	
Port-Kaiti	2006	
JNL - Matawhero	2005	
Carnarvon St - Port	2005	
Carnarvon St – Parkinson St	2005	
RT's	Quantity	Ave purchase date
Handheld	10	1995
Vehicle VHF Wide Band	9	1995
SCADA System DO VHF wide band	8	2002
Substation/Automation sites UHF	15	2001
Substation/Automation sites VHF Narrow Band	84	2003

Pilot Isolation Facilities	No. of Circuits	Service	Installed Year
Carnarvon Street	9	Voice(4)/Data(5)	1995
Valley Rd	3	Telecom/Voice/Data	1990's
Kaiti	2	Not Used	1990's
Parkinson St	2	Not Used	1990's
Makaraka	1	Not used	1990's

Wairoa	1	Telecom	2000
Kiwi	1	Telecom	1990's
Ngatapa	1	Telecom	1990's
Patutahi	1	Telecom	1990's
Pehiri	1	Telecom	1990's
Puha	1	Telecom	1990's
Ruatoria	1	Telecom	1990's
Te Araroa	1	Telecom	1990's
Tokomaru	1	Telecom	1990's
Tolaga	1	Telecom	1990's
Plunket Sub	1	Data	1980's
Bright St	1	Data	1980's
Reads Quay	1	Data	1980's
Birrel St	1	Data	1980's

The standard ODV maximum life assigned to communications equipment is 15 years. Modern equipment with more stable components and self tuning capability generally perform well during this life. Antennas and cables exposed to weather need more regular replacement (10 years). Usually technology advances make earlier system replacement desirable.

The isolation equipment is required to isolate telecom connections and ENL's communication circuits from earth potential rise in fault conditions at major substations. The isolation facilities are designed to ensure safety of personnel and protection of connected equipment. Use of this equipment will be phased out as fiber-optic circuits replace the need for copper communications circuits.

The wireless broadband 2.4G and 5G communications network was installed between 2005 and 2006 the relationship between age and performance of this system has not been determined at this stage.

2.3.14 Other assets

2.3.14.1 Generation

The age of standby generation assets is tabulated as follows...

Generators	Rating kVA	Manufacture Date
Carnarvon St	12	1960's
Makaretu	5	1960's
Arakihi	5	1960's
Mata Rd	5	1960's
Whakapunaki	5	1960's
Tikitiki	5	1960's
Te Araroa Gen 1	1250	2002
Ruatoria Gen 2	1250	2002
Tolaga Gen 4	1250	2002
Puha Gen 5	1250	2002
Matawhero Gen 6	1250	2002
Mahia Gen 3	1250	2002
Carnarvon Gen 7	600	1980's Rebuilt 2003

Condition is significantly influenced by usage patterns and maintenance undertaken.

The containers used for generator installations will need significant maintenance due to rusting before major work on the generator sets is required.

2.3.14.2 Software

The software assets are in a constant state of renewal and upgrade hence age and condition of these systems are difficult to determine. Currently all of the software systems in use are meeting the desired performance requirements.

2.3.15 Summary of assets

The assets are summarised in Table 2.3(a).

Table 2.3(a) – Summary of assets by category

Asset description	Quantity	Unit	Average age	Condition summary	ODRC	Percent of ODRC
Subtransmission line	327	km	27.8	Average	2470	2.86
Subtransmission Poles	2441	each	25	Average	4763	5.52
Subtransmission cable	2	km	1	Good	11	0.01
Other zone substation assets		total	6.4	New/good condition	4642	5.38
50/11kV and 33/11kV transformers	23	each		Average	2799	3.24
Distribution line	2453	Km	35	Condition Ageing	8786	10.18
Distribution Poles	26856	each	26	Condition Ageing	16404	19.01
Distribution cable	121	km	21	Above Average	8212	9.52
Voltage regulators	9	each		Average	299	0.35
Distribution Substations	3583	each	24	Average	2376	2.75
Distribution transformers	3509	each	24	Average	8831	10.23
Distribution Fuses	2856	each	26	Below Average	2032	2.35
Distribution switchgear	1820	each	21	Above Average	7747	8.98
LV lines	538	Km	35.4	Ageing	4011	4.65
LV Poles	9455	each	28	Ageing	3559	4.12
LV cable	187	km	25	Average	6455	7.48
Communications		total	3.7	Technology determines Condition	420	0.49
SCADA & system control		total	2.5	Technology determines Condition	679	0.79
Connection assets	24876	each	23	Customer Drives upgrades	1803	2.09
Total			22		86299	

Data source based on 2004 ODV

2.4 Justification for assets

ENL creates stakeholder service levels by carrying out a number of activities (described in Section 5) on its assets, including the initial step of actually building assets such as lines and substations. Some of these assets obviously need to deliver greater service levels than others e.g. Carnarvon substation in industrial Gisborne has a higher capacity and security level than Tahaenui substation in rural Wairoa. Hence a greater level of investment will be required that will generally reflect the magnitude and nature of the demand.

Matching the level of investment in assets to the expected service levels requires the following issues to be considered...

- It requires an intimate understanding of how asset ratings and configurations create service levels such as capacity, security, reliability and voltage stability.
- It requires the asymmetric nature of under-investment and over-investment to be clearly understood i.e. Over-investing creates service levels in excess of what is needed, but under-investing can lead to service interruptions (which typically costs about 10x to 100x as much as over-investing).
- It requires the discrete "sizes" of many classes of components to be recognised e.g. A 220kVA load will require a 300kVA transformer that is only 73% loaded. In some cases capacity can be staged through use of modular components.
- Recognition that the existing network has been built up over 80 years by a series of incremental investment decisions that were probably optimal at the time but when taken in aggregate at the present moment may well be sub-optimal.
- The need to accommodate future demand growth (noting that the ODV Handbook now prescribes the number of years ahead that such growth can be accommodated).

In theory an asset would be justified if the service level it creates is equal to the service level required. In a practical world of asymmetric risks, discrete component ratings, non-linear behavior of materials and uncertain future growth rates ENL considers an asset to be justified if its resulting service level is not significantly greater than that required

subject to allowing for demand growth and discrete component ratings.

A key practical measure of justification is level of optimisation required in the derivation of ENL's ODV. The ratio of ENL's ODRC to DRC based on ENL's 2004 ODV was 0.985, with a ratio close to 1 indicating a high level of justification.

3. Service levels

3.1 Consumer-oriented service levels

On an annual basis as part of both complying with regulatory quality threshold requirements and on-going engagement with its customers, ENL formally surveys and consults with stakeholder and customer representative groups. The primary required outcome of the consultation process is for ENL to receive feedback from customers on which attributes of supply are important to them, preferences for price and reliability and how well ENL is delivering those attributes and/or preferences. Responses received are then considered by ENL's management team and significantly influence the setting of service levels.

To ensure objectivity is maintained, every second year the consultation process is undertaken by an independent consultant.

Stakeholder/customer groups included in the latest consultation round completed in early 2006 were;

- . ENL's 24 largest customers, (by energy consumption)
- . GreyPower, (both Gisborne and Wairoa)
- . Federated Farmers, (East Cape)
- . District Council economic development units, (both Gisborne and Wairoa)
- . Gisborne Chamber of Commerce
- . Five largest energy retailers operating on ENL's network

The last five representative groups above are considered as proxies for ENL's 24,840 "mass market" customers and the community in general.

The following table summaries the responses received from the 2006 consultation round and how ENL has interpreted those responses.

Consumers responses	ENL's interpretation
Continuity is the most important supply attribute by far.	Out of all the things ENL does, the primary focus needs to be on supply interruptions and restoration times. Whether ENL improves or simply maintains these areas and whether line charges are increased to do so are addressed by other questions.
Restoration is the second most important supply attribute by far.	
Supply continuity is rated as Very Good	ENL should maintain continuity at about the

or Excellent by 78% of valid responses.	current levels, improve where it can without increasing line charges, but ENL definitely shouldn't let continuity decline.
Supply restoration is rated as Very Good or Excellent by 100% of valid responses.	ENL should maintain restoration performance at about the current levels, improve where it can without increasing line charges, but definitely shouldn't let restoration performance decline.
Customers are not overly happy with the levels of interference/ they experience – 71% of valid responses from large customers rate ENL's performance as only Average or Good.	Investigation & monitoring is undertaken on an individual customer and network wide basis to determine whether interference is actually a problem, (deviation from regulatory limits) or just "noticeable", and whether interference is due to network or customer owned asset performance issues.
Notification of planned shutdowns is rated as Very Good or Excellent by 85% of valid responses.	ENL should maintain its timeliness and addressing accuracy of planned shutdown notices, improve where it can without increasing line charges, but it definitely shouldn't let performance decline.
Almost all consumers would prefer to continue paying about the same line charges to receive about the same supply reliability.	ENL should keep its line charges about the same (notwithstanding the price path thresholds) and keep its supply reliability about the same, make creeping improvements where possible, but definitely shouldn't let reliability decline.
In addition the valid responses from large customers on interference/flicker 72%, these customers seem to have a good understanding of the causes.	This adds a degree of credibility to ENL's customers concerns.

3.1.1 Primary customer service levels

ENL's customers have clearly signaled that continuity and restoration are the two operational performance attributes that they value the most and at a minimum ENL needs to maintain current levels of performance without increasing its line charges.

Operational Performance

To measure operational performance with respect to continuity and restoration, ENL in accordance with industry standard practice and the

Information Disclosure and Electricity Distribution Threshold regimes, sets targets for the next five years against the following key indices;

- SAIDI – system average interruption duration index. The measure of how many system minutes of supply are interrupted per year.
- SAIFI – system average interruption frequency index. The measure of how many system interruptions occur per year.
- CAIDI – consumer average interruption duration index. This is a measure of how long the average connection is without supply per year.

Projections of the key operational performance targets for the next 10 years are;

Measure	2006/07	2007/08	2008/09	2009/10	2010-2016
SAIDI	285	285	285	285	285
SAIFI	2.0	2.0	2.0	2.0	2.0
CAIDI	142	142	142	142	142

In accordance with the Commerce Commission Targeted Control Regime for lines businesses ENL is required to comply with a quality threshold. This means its annual SAIDI and SAIFI performance cannot exceed the set 5 year averages of SAIDI = 366 and SAIFI = 3.34. These regulatory averages will be reset in 2009.

ENL has set the same SAIDI, SAIFI and CAIDI targets for the planning period as a driver to achieve a level of sustainable steady state performance that considers network asset age/location/configuration, financial implications and customer expectations. Investment to improve service beyond steady state and regulated levels is seen as over investment and as such cannot be justified.

In the longer term, (beyond 5 years), customer’s steady state performance expectations and regulatory performance targets may not be achieved because of constraints on ENL’s ability to invest in the network due to regulatory revenue control. A shortfall in achievable renewal investment versus required renewal rates will result in the average age of the network increasing and a backlog of asset renewal occurring.

Issues regarding levels of network investment and resulting operational performance are being further reviewed and will be updated as appropriate in future versions of ENL’s AMP.

Complimentary to key operational performance targets are targets for the restoration of faults which affect the supply to customers. ENL's targeted performance is to meet the targets as prescribed in current Use of System Agreements entered into with energy retailers. These minimum targets are;

Fault Restoration

Urban	4 hours
Rural	8 hours

The control operations staff and/or faults service contractor record response times and the causes for network outages in the System Outage database which facilitates analysis and internal and disclosure reporting. A delegated engineering officer is responsible for reviewing the recorded figures and implementing improvements or corrective action when necessary. Comparisons of the response times are made with benchmark values to indicate trends. Outage duration and repair time components are incorporated into the performance indices for industry benchmarking.

Line Function Services Charges

Customer consultation has determined that in general ENL's customers are satisfied with the current level of network operational performance and are unwilling to pay for improved performance.

ENL's service level with respect to lines charges is that it will comply with the requirement of the Commerce Commission's Targeted Price Control Regime, (CPI-X). Currently the X assigned to ENL is 2%. This will be reset in 2009.

3.1.2 Secondary customer service levels

Secondary service levels are the attributes of service that ENL's consumers ranked below the attributes of supply continuity and restoration, and line function services charges. A key point to note is that most of these service levels are process driven which has two implications...

- They tend to be cheaper than fixed asset solutions e.g. someone could work a few hours overtime to process a back log of new connection applications.

- There are heterogeneous in nature i.e. they can be provided exclusively to consumers who are willing to pay more in contrast to fixed asset solutions which will equally benefit all consumers connected to an asset regardless of whether they pay.

The attributes of service which customers have ranked as secondary in importance and which ENL sets and monitors performance against targets are;

- Shutdown notification and coordination.
To provide notification timing and shutdown advice in accordance with current Use of System Agreements, ENL has implemented the industry standard pro-forma email notification process. This process identifies affected ICPs and standardized information is emailed to relevant energy retailers. The energy retailers in turn advise their customers accordingly.
When organizing a shutdown, ENL directly contacts large and significant customers, (e.g. rest homes) to discuss and negotiate outage times which as much as possible are set to accommodate the preferences of those customers.
- How quickly ENL processes Network Alteration applications for new connections, changes in required capacity or total disconnection (only 17% of large consumers have recently applied for a new connection).
- How promptly and how well ENL provides technical advice to consumers on network asset related issues, (only 29% of large consumers have ever sought technical advice).
- How promptly and how well ENL responds to quality of supply issues. The quality of supply is measured in terms of voltage flicker complaints, low voltage complaints, harmonic content in supply, interference to telecommunication assets and radio interference complaints.
The legislation and regulations that determine ENL supply quality requirements include The Electricity Act 1992, Electricity Regulations 1997 and The Commerce Act 1986.
Deviations from regulatory limits and poor supply quality levels are recorded in the network defects database as soon as they are identified. Corrective actions are carried out as soon as practicable. Issues requiring longer term supply quality improvement to the network asset are incorporated into the company design standards and management plans for the affected asset categories.

- How prompt and effective ENL's Complaint and Dispute Resolution Process is.

ENL is an electricity company member of the complaints scheme administered by the Electricity & Gas Complaints Commission. Accordingly ENL is compliant with the Commission's Code of Practice for Electricity Companies and its Complaint and Dispute Resolution Procedure. ENL performance targets are aligned with those of the Commission.

ENL secondary customer service level performance targets for the next 10 years are;

Attribute	Measure	2006/07	2007/08	2008-2016
Notification of Planned Outages	Number of outages not notified to energy retailers at least 10 working days in advance.	0	0	0
	Number of individual ICP omissions or errors in outage notification to energy retailers.	0	0	0
	Number of large or significant customers not consulted directly during outage planning.	0	0	0
Processing of Network Alteration applications	Number of working days to process correctly completed applications for a new domestic or small commercial supply where infrastructure, capacity or resource consent issues do not exist.	5	5	5
	Number of working days to process correctly completed applications for load increases/decreases for existing domestic or small commercial ICPs where infrastructure, capacity or resource consent issues do not exist.	5	5	5
Provision of technical	Number of working days to acknowledge inquiry.	2	2	2

advice				
	Number of working days to investigate and respond to a customer inquiry.	20	20	20
Supply Quality issues	Number of working days to acknowledge a customer reported supply quality issue and initiate an investigation.	5	5	5
Complaints Procedure	Number of working days ENL has to acknowledgement that a complaint has been received from a customer.	2	2	2
	Number of working days to when an unresolved dispute is deemed deadlocked.	20	20	20
	Number of working days to when an unresolved dispute is deemed deadlocked. (with ENL having advised that additional investigation time is required)	40	40	40

3.1.3 Other Stakeholder service levels

In addition to the service levels that are of primary and secondary importance to consumers, ENL has safety and environmental management service levels that benefit stakeholders.

3.1.3.1 Safety

EIL is committed to providing and maintaining a safe and healthy environment for all of its employees, contractors, customers and the public.

EIL's regulatory and corporate responsibilities for health & safety management across the businesses it manages are described in the EIL Health & Safety Manual. This manual also determines for each business the health & safety management policies and procedures required to be implemented to meet those responsibilities.

With respect to ENL key regulations and industry codes of practice that it has a responsibility to comply with are;

- Health & Safety in Employment Act 1992.
- Electricity (Hazards from Trees) Regulations 2003.
- Maintaining safe clearances from live conductors (NZECP34:2001).
- Power system earthing (NZECP35:1993).
- Safety Manual –Electricity Industry 2004, Parts 1,2 &3

Key elements of the EIL Health & Safety Manual which ENL implements are;

- Workplace Hazard Management
- Contractor Health & Safety Management
- Public Safety – Asset Hazard Management

As drivers to achieve the highest standards of safety performance ENL has set the following targets for every year of the planning period and beyond;

- Zero accidents, events or incidents which involve the public and ENL assets
- Zero serious harm incidents involving employees or contractors;
Lost Time Injury Accidents = 0.

3.1.3.2 Environmental management

In planning and undertaking activities which have implications for the environment, EIL is committed to managing and operating its businesses in a manner which meets the community's environmental expectation. For ENL this requires a balance be met between the community's need for electricity and that of effective environmental management.

ENL has the environmental management performance target of full compliance with all laws, regulations, resource consent and local authority District Plan conditions.

3.2 Industry and Business performance targets

As a monopoly lines business ENL is required to disclose a range of internal performance and efficiency measures as required by the Electricity (Information Disclosure) Requirements 2004. ENL aligns future performance targets against the Disclosure measures. The measures which are applied to target asset management performance are described below;

3.2.1 Asset performance

Complimentary to the primary customer service levels for SAIDI, SAIFI and CAIDI, Section 3.1.1, ENL also forecasts and monitors network performance via the number of faults per 100km for both overhead and underground assets at per asset voltage category. This targeted performance for the next ten years is;

SERVICE PERFORMANCE TARGETS							
	2005/6 Actual	2006/07	2007/08	2008/09	2009/10	2010/11	2011-2016
Interruptions							
B Planned	89	72	72	72	72	72	72
C Unplanned	237	130	130	130	130	130	130
Faults/100km							
Total							
50 kV	3.72	3.0	3.0	3.0	3.0	3.0	3.0
33 kV	8.74	5.88	5.88	5.88	5.88	5.88	5.88
11 kV	7.49	6.6	6.6	6.6	6.6	6.6	6.6
Total	7.09	5.8	5.8	5.8	5.8	5.8	5.8
Underground							
50 kV	0.00	0.00	0.00	0.00	0.00	0.00	0.00
33 kV	0.00	0.00	0.00	0.00	0.00	0.00	0.00
11 kV	4.64	3.10	3.10	3.10	3.10	3.10	3.10
Total	5.00	3.08	3.08	3.08	3.08	3.08	3.08
Overhead							
50 kV	3.73	3.05	3.05	3.05	3.05	3.05	3.05
33 kV	8.74	5.88	5.88	5.88	5.88	5.88	5.88
11 kV	7.54	6.6	6.6	6.6	6.6	6.6	6.6
Total	7.00	5.8	5.8	5.8	5.8	5.8	5.8
SAIDI							
Total	349.36	285	285	285	285	285	285
B Planned	27.50	43	43	43	43	43	43
C Unplanned	321.86	242	242	242	242	242	242
SAIFI							
Total	2.62	2.00	2.00	2.00	2.00	2.00	2.00
B Planned	0.15	0.30	0.30	0.30	0.30	0.30	0.30
C Unplanned	2.47	1.70	1.70	1.70	1.70	1.70	1.70
CAIDI							
Total	133	142	142	142	142	142	142

B Planned	187	143	143	143	143	143	143
C Unplanned	130	142	142	142	142	142	142

Notes

1. 2005/06 Actual for Information Disclosure not yet audited & exclude Transpower outages.
2. Planned SAIDI = 15% of Total
3. Targeted Control Regime 5 Year Average SAIDI = 366 , SAIFI = 3.34

3.2.1 Financial efficiency measures

ENL's projected financial efficiency measures are shown below. These measures are...

- Direct costs per km of line – [direct expenditure as defined in the disclosure requirements] / [system length at year end].
- Indirect costs per ICP – [indirect expenditure as defined in the disclosure requirements] / [number of ICPs at year end].

Measure	2006/07	2007/08	2008/09	2009/10	2010/11	2011 - 2016
Direct costs \$/km	675	675	675	675	675	675
Indirect costs \$/ICP	70	70	70	70	70	70

2004/05 Information Disclosure industry averages, Direct Cost = \$1,196/ICP; Indirect Costs = \$69/km.

3.2.2 Energy delivery efficiency measures

ENL's projected energy efficiency measures are shown below. These measures are...

- Load factor – [kWh entering the network during the year] / [[max demand for the year] x [hours in the year]].
- Loss ratio – [kWh lost in the network during the year] / [kWh entering the network during the year].
- Capacity utilisation – [max demand for the year] / [installed transformer capacity].

It should be noted that the energy delivery efficiency parameter values achieved are predominately determined by the network configuration

and assets required to supply the demand profiles of customers. Over the next ten years ENL expects to maintain a sustainable steady state position with respect to energy delivery efficiency delivery. Tactics to achieve this are described in Section 5.0.

Measure	2006/07	2007/08	2008/09	2009/10	2010/11	2011-2016
Load factor	62.6%	62.6%	62.6%	62.6%	62.6%	62.6%
Loss ratio	6.2%	6.2%	6.2%	6.2%	6.2%	6.2%
Capacity utilization	28.2%	28.2%	28.2%	28.2%	28.2%	28.2%

2004/05 Information Disclosure industry averages, Load Factor = 64.4%; Loss Ratio = 6.3%; Capacity Utilization = 32.7%.

3.3 Justification of service levels

ENL’s service levels are justified through consideration of the following;

- By what is achievable and sustainable within current revenue boundaries. This is the primary consideration affecting the ability to set and achieve marked improvement in future performance.
- By the physical characteristics and configuration of the assets which comprise the network and which are difficult and expensive to significantly alter (but which can be altered if a consumer or group of consumers agrees to pay for the alteration). As with other lines businesses ENL has legacy decisions which have established service levels that would require significant additional investment to alter. Examples include the use of second hand 50kV insulators in the 1960’s that are now impacting on reliability and the construction of distribution lines across country as opposed to alongside accessible roads.
- Through consideration of customer consultation results and the subsequent analysis to determine the customer’s primary service level requirements and their agreement to pay.
- Achieving compliance with all legislative and regulatory requirements applicable to the ownership and operation of the network. This includes when an external agency imposes a service level on ENL (or in some cases an unrelated condition or restriction

that manifests as a service level such as requirement to place new lines underground

When establishing performance levels ENL carried out a comparison against 3 benchmarking groups for the purpose of determining its desired position in the market. Information has been derived from analysis of 2004/05 information disclosures. The benchmarking groups are as follows:

- All New Zealand lines companies: If the long term expectation is that only a quarter of the existing companies will exist then it is logical that ENL targets being in the top quartile in terms of performance to justify its existence.
- Rural line companies i.e. those with a customer density of less than 10 connections/km of network. ENL is a network of rural nature despite a large urban centre. This benchmark group helps identify what characteristics of rural networks are performance disadvantages and what are commonly held myths.
- A selected benchmark group of similar size, customer density, urban/rural split, and transmission remoteness. This group provides the most accurate measure of our existing performance.

Based on the criteria above and appropriate benchmarking, service levels have been set to place ENL in an average industry position. Further previous annual improvement targets have been smoothed to reflect steady state performance targets for the immediate future.

4. Development plans

ENL's development plans are driven almost totally by demand but on occasions may be influenced by other drivers, primarily security of supply.

At the most fundamental level, demand is created by each individual consumer drawing energy across their individual connection. The demand at each connection aggregates "up the network" to the distribution transformer, then to the distribution network, the zone substation, the sub-transmission network back to the GXP and ultimately through the grid to a power station.

4.1 Planning approach & criteria

4.1.1 Planning unit

ENL has adopted the 11kV distribution feeder as its fundamental planning unit which typically represents one or perhaps two of the following combinations of consumer connections...

- An aggregation of up to 1,000 urban domestic consumer connections.
- An aggregation of up to 300 urban commercial consumer connections.
- An aggregation of up to 20 or 30 urban light industrial consumer connections.
- An aggregation of anywhere from 20 to 100 rural domestic or farm consumer connections.
- A single large industrial consumer connection.
- Injection of up to 5MW of generation (Waihi and the diesel generators).

Physically this planning unit will usually be based around the lines or cables emanating from an 11kV board.

4.1.2 Planning approaches

ENL tends to plan its assets in three different ways (strategically, tactically and operationally) as shown below...

Planning approaches

Attribute	Strategic	Tactical	Operational
Asset description	<ul style="list-style-type: none"> Assets within GXP. Sub-transmission lines & cables. Major zone substation assets. Load control injection plant. Central SCADA & telemetry. Distribution configuration e.g. Decision to upgrade to 22kV. 	<ul style="list-style-type: none"> Minor zone substation assets All individual distribution lines (11kV) All distribution line hardware. All on-network telemetry and SCADA components. All distribution transformers and associated switches. All HV consumer connections. 	<ul style="list-style-type: none"> All 400V lines and cables. All 400V consumer connections. All consumer metering and load control assets.
Number of consumers supplied.	<ul style="list-style-type: none"> Anywhere from 500 to about 7,500 	<ul style="list-style-type: none"> Anywhere from 1 to about 500. 	<ul style="list-style-type: none"> Anywhere from 1 to about 50.
Impact on balance sheet and asset valuation.	<ul style="list-style-type: none"> Individual impact is low. Aggregate impact is moderate. 	<ul style="list-style-type: none"> Individual impact is moderate. Aggregate impact is significant. 	<ul style="list-style-type: none"> Individual impact is low. Aggregate impact is moderate.
Degree of specificity in plans.	<ul style="list-style-type: none"> Likely to be included in very specific terms, probably accompanied by an extensive narrative. 	<ul style="list-style-type: none"> Likely to be included in specific terms, and accompanied by a paragraph or two. 	<ul style="list-style-type: none"> Likely to be included in broad terms, with maybe a sentence describing each inclusion.
Level of approval required.	<ul style="list-style-type: none"> Approved in principal in annual business plan. Individual approval by board and possibly shareholder. 	<ul style="list-style-type: none"> Approved in principal in annual business plan. Individual approval by chief executive. 	<ul style="list-style-type: none"> Approved in principal in annual business plan. Individual approval by GM - Operations.
Characteristics of analysis.	<ul style="list-style-type: none"> Tends to use one-off models and analyses involving a significant number of parameters and extensive sensitivity analysis. 	<ul style="list-style-type: none"> Tend to use established models with some depth, a moderate range of parameters and possibly one or two sensitivity analyses. 	<ul style="list-style-type: none"> Tends to use established models based on a few significant parameters that can often be embodied in a "rule of thumb".

To further guide its thinking ENL has developed the following “investment strategy matrix” shown in Figure 4.1.2(b) which broadly defines the nature and level of investment and the level of investment risk implicit in different circumstances of growth rates and location of growth.

Figure 4.1.2(b) – Investment strategy matrix

Location of demand growth	Outside of existing network footprint	<p>Quadrant 3</p> <ul style="list-style-type: none"> • CapEx will be dominated by new assets that require both connection to existing assets and possibly upstream reinforcement. • Likely to absorb lots of cash – may need capital funding. • Easily diverts attention away from legacy assets. • Likely to result in low capacity utilisation unless modular construction can be adopted. • May have high stranding risk. 	<p>Quadrant 4</p> <ul style="list-style-type: none"> • CapEx will be dominated by new assets that require both connection to existing assets and possibly upstream reinforcement. • Likely to absorb lots of cash – may need capital funding. • Easily diverts attention away from legacy assets. • Need to confirm regulatory treatment of growth. • May have a high commercial risk profile if a single customer is involved. 	
	Within existing network footprint	<p>Quadrant 1</p> <ul style="list-style-type: none"> • CapEx will be dominated by renewals (driven by condition). • Easy to manage by advancing or deferring straightforward CapEx projects. • Possibility of stranding if demand contracts. 	<p>Quadrant 2</p> <ul style="list-style-type: none"> • CapEx will be dominated by enhancement rather than renewal (assets become too small rather than worn out). • Regulatory treatment of additional revenue arising from volume thru' put as well as additional connections may be difficult. • Likely to involve tactical upgrades of many assets 	
		Lo	Prevailing load growth	Hi

ENL’s current demand growth falls mainly in Quadrants 1 and 2 as follows...

Quadrant 1

Areas such as Matawai, Raupunga, Waikaremoana and the semi-rural areas around Wairoa are quite clearly in this quadrant – there is little if any growth so investment tends to be dominated by Renewal i.e. assets “wear out” rather than get “too small”. Declining population particularly in the Wairoa District increases the risk of stranding.

Quadrant 2

Areas such Makaraka, Matawhero, the Gisborne industrial estate, the Kaiti / Port area of Gisborne and the Mahia Peninsula are clearly in this quadrant – growth is high but it is largely within or very close to the existing network footprint. As ENL further examines in section 4.3.2 the impending forestry maturity cycle could drive very significant growth around Matawhero over the next 5 to 20 years if the logs are processed in the district instead of simply exported.

Investment in this quadrant tends to be dominated by Up-sizing rather than Renewal i.e. Assets get “too small” rather than “wear out”.

4.1.3 Trigger points for planning new capacity

Because new capacity has ODV, balance sheet, depreciation and ROI implications, ENL will meet demand by other, less investment-intensive means. This discussion also links strongly to the discussion of asset life cycle in section 5.1.

The first step in meeting future demand is to determine if the projected demand will exceed any of the defined trigger points for asset location, capacity, reliability, security or voltage. These points are outlined for each asset class in Table 4.1.3(a).

If and only if a trigger point is exceeded does ENL then move to identify a range of options to bring the assets’ operating parameters back to within the acceptable range of trigger points. These options are described in section 4.2 which also defines a preference for avoiding new investment unless a commercial return is certain.

Table 4.1.3(a) – Summary of planning “trigger points”

Asset category	Location trigger	Capacity trigger	Reliability trigger	Security trigger	Voltage trigger
LV lines & cables	<ul style="list-style-type: none"> Existing LV lines and cables don't reach the required location. 	<ul style="list-style-type: none"> Not applicable – tends to manifest as voltage constraint. 	<ul style="list-style-type: none"> Operational performance/reliability outside industry stds. 	<ul style="list-style-type: none"> Not applicable. 	<ul style="list-style-type: none"> Voltage at consumers' premises consistently drops below 0.94pu.
Distribution substations	<ul style="list-style-type: none"> Substation is not efficiently located in relation to load. 	<ul style="list-style-type: none"> Where fitted, MDI reading exceeds 80% of nameplate rating. 	<ul style="list-style-type: none"> Operational performance/reliability outside industry stds. 	<ul style="list-style-type: none"> Excursion beyond triggers specified in section 4.2.2 	<ul style="list-style-type: none"> Voltage at LV terminals consistently drops below 1.0pu.
Distribution lines & cables	<ul style="list-style-type: none"> Load cannot be reasonably supplied by LV configuration therefore requires new distribution lines or cables and sub. 	<ul style="list-style-type: none"> Conductor current consistently exceeds 66% of thermal rating for more than 3,000 half-hours per year. Conductor current exceeds 100% of thermal rating for more than 10 consecutive half-hours per year. 	<ul style="list-style-type: none"> Operational performance/reliability outside industry stds. 	<ul style="list-style-type: none"> Excursion beyond triggers specified in section 4.2.2 	<ul style="list-style-type: none"> Voltage at HV terminals of transformer consistently drops below 10.5kV and cannot be compensated by local tap setting.
Zone substations	<ul style="list-style-type: none"> Substation is not efficiently located in relation to load. 	<ul style="list-style-type: none"> Max demand consistently exceeds 100% of nameplate rating. 	<ul style="list-style-type: none"> Operational performance/reliability outside industry stds. 	<ul style="list-style-type: none"> Excursion beyond triggers specified in section 4.2.2 	<ul style="list-style-type: none"> Distribution voltage depression cannot be compensated for locally
Sub-transmission lines & cables	<ul style="list-style-type: none"> Load cannot be reasonably supplied by distribution configuration therefore requires new sub-trans lines or cables and zone sub. 	<ul style="list-style-type: none"> Conductor current consistently exceeds 66% of thermal rating for more than 3,000 half-hours per year. Conductor current exceeds 100% of thermal rating for more than 10 consecutive half-hours per year. 	<ul style="list-style-type: none"> Operational performance/reliability outside industry stds. 	<ul style="list-style-type: none"> Excursion beyond triggers specified in section 4.2.2 	<ul style="list-style-type: none"> Voltage depression that cannot be compensated for at GXP.

4.2 Prioritisation methodology

4.2.1 Options for meeting demand

Table 4.1.3(a) defines the trigger points at which the capacity of each class of assets needs to be increased. Exactly what is done to increase the capacity of individual assets within these classes can take the following forms (in a broad order of preference)...

- Do nothing, and simply accept that one or more parameters have exceeded a trigger point. In reality, do nothing options would only be adopted if the benefit-cost ratio of all other reasonable options were unacceptably low and if assurance was provided to the chief executive that the do nothing option did not represent an unacceptable increase in risk to ENL. An example of where a do nothing option might be adopted is where the voltage at the far end of a remote rural feeder is unacceptably low for a short period at the height of the holiday season – the benefits of correcting such a constraint are simply too low.
- Operational activities, in particular switching on the distribution network to shift load from heavily-loaded to lightly-loaded feeders to avoid new investment or winding up a tap changer to mitigate a voltage problem. The downside to this approach is that it may increase line losses, reduce security of supply, or compromise protection settings.
- Influence consumers to alter their consumption patterns so that assets perform at levels below the trigger points. Examples might be to shift demand to different time zones, negotiate interruptible tariffs with certain consumers so that overloaded assets can be relieved, or assist a consumer to adopt a substitute energy source to avoid new capacity.
- Construct distributed generation so that adjacent assets performance is restored to a level below their trigger points. Distributed generation would be particularly useful where additional capacity could eventually be stranded or where primary energy is going to waste e.g. Waste steam from a process.
- Modify an asset so that the assets trigger point will move to a level that is not exceeded e.g. by adding forced cooling. This is

essentially a sub-set of the above approach, but will generally involve less expenditure. This approach is more suited to larger classes of assets such as 50/11kV transformers.

- Retrofitting high-technology devices that can exploit the features of existing assets (including the generous design margins of a bygone era). Examples might be using remotely switched air-breaks to improve reliability, or using advanced software to thermally re-rate heavily-loaded lines.
- Install new assets with a greater capacity that will increase the assets trigger point to a level at which it is not exceeded. An example would be to replace a 200kVA distribution transformer with a 300kVA so that the capacity criteria is not exceeded.

In identifying solutions for meeting future demands for capacity, reliability, security and voltage ENL considers options that cover the above range of categories. The benefit-cost ratio of each option is considered (including estimates of the benefits of environmental compliance and public safety) and the option yielding the greatest benefit is adopted. ENL uses the model in figure 4.2.1(a) to broadly guide ENL's adoption of various approaches...

Figure 4.2.1(a) – Options for increasing capacity

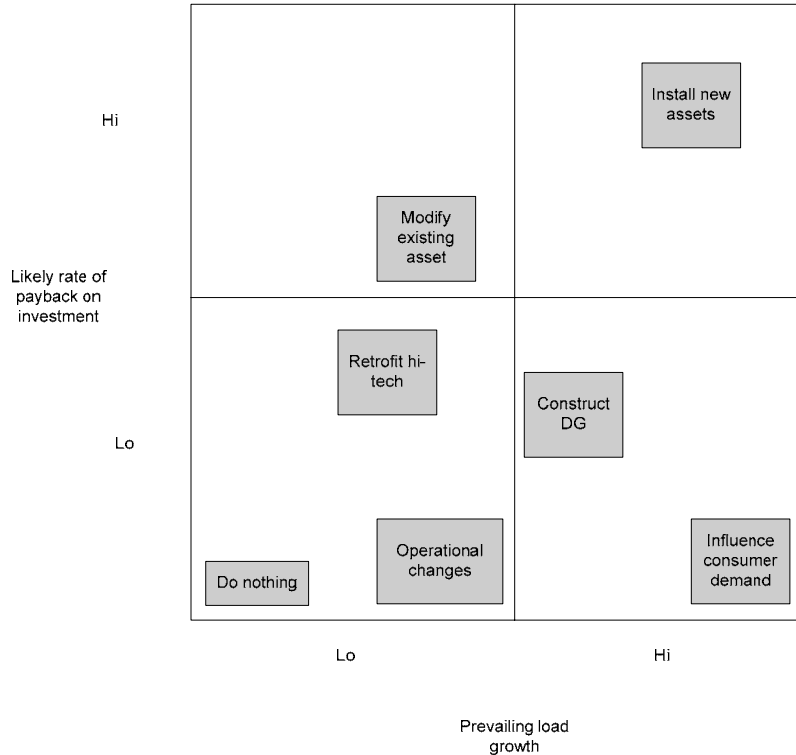

4.2.2 Meeting security requirements

A key component of security is the level of redundancy that enables supply to be restored independently of repairing or replacing a faulty component. Typical approaches to providing security to a zone substation include...

- Provision of an alternative sub-transmission circuit into the substation, preferably separated from the principal supply by a bus-tie.
- Provision to back-feed on the 11kV from adjacent substations where sufficient 11kV capacity and interconnection exists. This obviously requires those adjacent substations to be restricted to less than nominal rating.
- Use of local generation.

The most pressing issue with security is that it involves a level of investment beyond what is obviously required to meet current demand.

4.2.2.1 Prevailing security standards

The commonly adopted security standard in New Zealand is the EEA Guidelines which reflect the UK standard P2/5 that was developed by the Chief Engineer’s Council in the late 1970’s. P2/5 is a strictly deterministic standard ie. it states that “this amount and nature of load will have this level of security”.

Deterministic standards are beginning to give way to probabilistic standards in which the value of lost load and the failure rate of supply components is estimated to determine an upper limit of investment to avoid interruption.

4.2.2.2 Issues with deterministic standards

A key characteristic of deterministic standards such as P2/5 and the EEA Guidelines is that rigid adherence generally results in at least some degree of over investment.

4.2.2.3 Contribution of local generation to security

To be of any use from a security perspective, local generation would need to have 100% availability which is unlikely from a reliability perspective and even less likely from a primary energy perspective such as run-of-the-river hydro, wind or solar. For this reason the emerging UK standard P2/6 provides for minimal contribution of such generation to security.

4.2.2.4 ENL’s security standards

ENL’s security standards were derived during a detailed review undertaken in August 2001, which also identified preferred solutions to security upgrades. The base security criteria apply to all network design and are as follows...

Class	Range of group peak demand (GPD) MVA	No. of customers effected	Security Level	Contingent Capacity	Time to restore after 1 st event	Time to restore after 2 nd event
-------	--------------------------------------	---------------------------	----------------	---------------------	---	---

D	More than 25MVA i.e. transmission, GXP or sub-transmission rings .	15,000 or more	n-1	100%	Maintain 100% GPD less 12MVA. Remaining 12MVA restored within 3 hours.	Repair time.
C	Between 12 and 25 MVA ie. small GXP, primary CBD & urban substations	7,000 to 15,000	n-1	100%	Maintain 100% of GPD.	Restore 90% of GPD within 3 hours and remaining 10% in time to repair.
B1	Between 6 and 12 MVA ie. Primary urban or industrial substations.	3,500 to 7,000	n	100%	Restore 75% of GPD within 15 min, restore 90% within 3 hours, and remaining 10% in time to repair.	Within 3 hrs restore 90%, repair time 100%
B2	Between 3 and 6 MVA ie. single transf subs and urban meshed feeders	1,750 to 3,500	n	80%	Restore 75% of GPD within 30 minutes, 90% within 3 hours and remaining 10% in time to repair.	Restore 100% in time to repair.
B3	Between 1 and 3 MVA ie. rural zone substation, meshed feeders.	500 to 1,750	n	67%	Restore 50% of GPD within 1 hour, 90% within 3 hours, remaining 10% in time to repair.	Restore 100% in time to repair.
A	Less than 1MVA ie. rural feeders, urban spurs, distribution transformers	Less than 500	n	Note 1	Restore 100% in time to repair.	Restore 100% in time to repair.

Note 1 - refer to ENL's Customer Service Standards for LV Network backup, dual distribution transformer capacity or temporary supply criteria. Temporary options include construction of prefabricated OH lines, HV or LV flexible surface jumpers or 300kVA generator supplies.

The following table confirms that ENL's target security levels are being met at zone substation level...

Sub.	Target security	Projected 2015/16 load	Additional provision for security
Carnarvon	C	Expected load well within 11kV back-feeding capacity from Parkinson & Port.	None required
JNL	B1	New substation to take up predicted shortfall at Matawhero	None required
Kaiti	C	Expected to be about 95% of nominal capacity, so will off-load a few MW to Port.	Possibility that in the long term not all Kaiti load could be back-fed on the 11kV from Port. Single transformer is a recognised point of weakness.
Makaraka	B1	Expected load not expected to	None required

		exceed transformer capacity	
Matawhero	C	Expected load well within capacity	None required
Ngatapa	B3	Expected load well within capacity	None required
Parkinson	C	Expected load well within capacity	None required
Patutahi	B1	Expected load well within capacity of either transformer.	None required.
Pehiri	B3	Expected load well within capacity	None required.
Port	C	Expected load well within capacity	None required.
Puha	B2	Expected load within capacity but only 1 transformer	Security provisions will be required
Ruatoria	B3	Expected load well within capacity of diesel generator and 11kV back-feeding capability.	None required.
Te Araroa	B3	Expected load could be totally supplied by diesel generator.	None required.
Tokomaru	B3	Expected load well within capacity of diesel generator and 11kV back-feeding capability.	None required.
Tolaga	B3	Expected load well within capacity of diesel generator and 11kV back-feeding capability.	None required.
Blacks Pad	B3	New substation planned	Sub-transmission development
Kiwi	B2	Expected load will require reconfiguration	Upgrade feeder assets
Tahaenui	B3	Expected load well within capacity	None required
Waihi	B2	Expected load within capacity	None required
Tuai	A	Expected load will never merit any alternative supply other than the possibility of re-locating a diesel generator if an outage looked prolonged.	None required.

The key contingency methods to achieve the zone substation security levels are as follows...

Zone Substation Support Capacity

Location	% Load Support	Contingency Method
Te Araroa Sub	100%	Generator or Ruatoria 30% via 11kV
Ruatoria Sub	100%	Generator or TeAraroa 30% and Tokomaru 35% via 11kV
Tokomaru Bay Sub	100%	Ruatoria 50% and Tolaga 50% via 11kV
Tolaga Bay Sub	100%	Generator or Tokomaru Bay 40% and Kaiti 40%
Kaiti Sub	100%	Load supplied from Port Substation and Carnarvon St via 11kV
Carnarvon Sub	100%	Dual Transformers or Port 50% and Parkinson 50%
Parkinson Sub	100%	Dual Transformers or Carnarvon 50% ,Matawhero 20% and Makaraka 30%

Makaraka Sub	100%	Carnarvon 50% ,Matawhero 20% Patutahi 10% and Parkinson 20%
Patutahi Sub	100%	Matawhero 50%, Pehiri 20%,Makaraka 20% and Puha 10%
Pehiri Sub	100%	Patutahi 100% (Uses Voltage Regulator)
Ngatapa Sub	100%	Patutahi 100% (Uses Voltage Regulator)
Puha Sub	100%	Generator 80% and Makaraka/Patutahi 20%
Matawhero Sub	100%	Dual Transformers or JNL (in progress 100%)
Port Sub	100%	Carnarvon 50% and Kaiti 50%
Kiwi Sub	100%	Waihi 50% or Dual supplies at 11kV
Blacks Pad Sub	100%	Generator 100%
Tahaenui Sub	100%	Kiwi Sub 100%

4.2.2.5 Guiding ENL's security policy

The following philosophies are fundamental to meeting ENL's security standards in the design of any network component...

- ENL's network is a low density, lightly loaded, distribution network. In a network of this character the provision of security via full redundancy can rarely be justified, is not cost efficient, and does not offer the best fault tolerance.
- Having said that, the preferred method of providing contingency supply will be via excess capacity in adjacent network components.
- Transformer loading for both zone and distribution transformers shall comply with IEC 354 which permits short duration overloads beyond nominal ratings under specified ambient and cyclical conditions.
- Alternative supply options will be built at the lowest voltage practical due to better inherent fault tolerance and flexibility with respect to interconnection.
- Cables will not be loaded into duty cycle levels of loading. Legacy jointing practices and installation design do not provide for this mode of operation.
- Preference will be given to ring design for an alternative route instead of double spur circuits.
- In rural spur networks the density of isolation points will be used to localize the effects of faults, to achieve customer service standards.

4.2.2.6 Specific security provisions

Transmission and Sub-transmission

- (n-1) security will be provided for all lines, cables, and equipment where loading exceeds 12MVA.
- Breakers' will be rated at 2x expected max demand to enable carrying of adjacent feeder loads.
- 33kV and 50kV CB's shall only be fitted with bypassing arrangements when supplying a spur line. This is to allow maintenance or repairs with the substation(s) on-line.

Zone Substations

- Transformer loading is to comply with IEC354. This permits overloading beyond nominal ratings under specified ambient and cyclical conditions. Thus the duration of restoration following a first interruption will result in no ageing beyond design provisions. Overloading of transformers such that ageing occurs will only be permitted for a second contingent event of up to 1 hour.
- Loading shall never exceed 150% of the transformers design rating.
- All connections and auxiliary equipment shall be rated for continuous operation at maximum load levels.
- Zone transformers will be rated to support a minimum of half the loading of neighboring zones.
- Installation of forced or assisted cooling will be used in preference to dual transformer installations or capacity upgrades where overload is required beyond IEC354 for contingent events.
- Zone substations carrying normal load in excess of 12MVA will be of dual transformer designs if it is unlikely that neighboring substations or feeder circuits will be able to support that substation after allowing for 10 years growth.
- 11kV switch panels will have a split bus arrangement where maximum demand is likely to exceed 6MVA. In single transformer

substations the incomer and the tie line to the adjacent substation shall be connected on opposite sides of the bus-tie. This ensures that at least one side of the 11kV bus can be energised.

- Urban 11kV feeder CB's shall not be normally loaded beyond 4MVA to allow sufficient capacity to pick up 2MVA from an adjacent feeder. The tie feeder between Carnarvon St and the Port area requires an 8MVA rating.
- Feeder cables from CB's must be rated to match CB excess capacity requirements which will typically be 6MVA in the urban, CBD or industrial area. In rural areas feeder cables shall be rated to 3MVA.
- All feeder circuits must have a tie switch external to the substation to another circuit from the opposite side of the bus or ties to a feeder from an adjacent substation.

Distribution

- 11kV circuits provide security via excess capacity, interconnection and isolation ability ie. the focus is on restoration speed and contingency provision as opposed to un-interruptible supply. Generally excess capacity and provision of mobile generation provide LV circuit security. In key commercial and industrial areas LV interconnection may be appropriate. Generally the installation of remote or automatically operated equipment shall be governed by the response times determined in section 4.2.2.4.
- 11kV pad mounted switchgear provisions...
 - No more than 3 transformers supplied from 1 switchboard without bus section.
 - Not more than 1MVA fed from switchgear supplied from a single cable circuit (excluding industrial situations).
 - No more than 1MVA of installed transformers and associated switchgear cascaded with no back feed.
- Not more than 1 cable circuit connected directly to the bus of a switchboard arrangement.
- In rural areas an air break switch will be installed as an isolation point every 50 customers or 25km of downstream circuit.

- Cables will be designed with 33% excess capacity to enable sharing of half the load of the connecting circuit where there are two alternative supply routes.
- Where overhead lines have tie capability (except ABC) they will be permitted to operate to 120% capacity in emergencies. Therefore they will be designed for sag and clearances appropriate to the maximum conductor operating temperature rather than 50^oC provided this does not exceed 75^oC.
- Lines will not be permitted to have more than 2% losses at installation.
- Spur assets (lines, cables, transformers) that cannot be supported via the LV network will have provisions for quick connect standby generation if normal loading exceeds 200kVA.
- Distribution transformers (less than 1,000kVA) will be permitted to overload to the ratings of IEC354.
- In commercial and industrial areas...
 - General distribution transformers will normally be 500kVA units. All cables shall be rated to allow loading of the transformer to 120%. This would provide overload capacity for 6 hours in winter peak areas at 20^oC (10 hours at 10^oC) and for 3 hours in summer peak areas at 30^oC given an initial loading at 80%. Actual load profiles for a given transformer where initial loading is less than 80% will enable extension to the period of overload.
 - LV interconnection shall normally be specified to allow for an out of service condition of an intermediate transformer. Where LV-interconnected, transformers should not exceed (other than for short duration's of less than 1 hour) 80% of their rating under normal operating conditions.
 - LV runs from transformer to an open tie point should not exceed 200m (400m from transformer to transformer).
 - Loads in industrial areas greater than 50kVA should have a dedicated LV feed.

- In urban domestic supply areas including small commercial areas located predominantly within an urban area...
 - Transformer size should be standardised to 200kVA in winter peak areas with cables rated to allow loading of the transformer to 133% and to 300kVA in summer peak areas with cables rated to allow loading of the transformer to 100%.
 - Each LV feeder should not be supporting more than 25 domestic supplies assuming an ADMD of 3kVA.
 - LV interconnection would normally only be provided where a small commercial shopping centre is located within a predominately urban area. 300kVA transformers may be required.
 - Provision of quick mobile substation connections to the LV is preferred to the provision of LV interconnection.
- Transformers must be able to be isolated from LV bus bars via incomer links where LV interconnection to another transformer is provided.

4.2.3 Choosing the option

The level of analysis is guided by the bottom row of Table 4.1.2(a). In particular, the underlying principles will be reused for sufficiently similar circumstances, whilst for new situations previous principles with suitable modifications are applied.

Broadly the cheapest option that meets minimum consumer needs, safety and environmental standards and revenue constraints will be chosen and modified to suit particular circumstances such as likely future load growth.

4.3 Demand forecast

4.3.1 Current demand

4.3.1.1 Gisborne Region

ENL's current after diversity maximum demand (ADMD) at Massey Rd GXP is 40.912MW, which is disaggregated in Figure 4.3.1.1(a).

**Figure 4.3.1.1(a) – Gisborne Region
Maximum Demand**

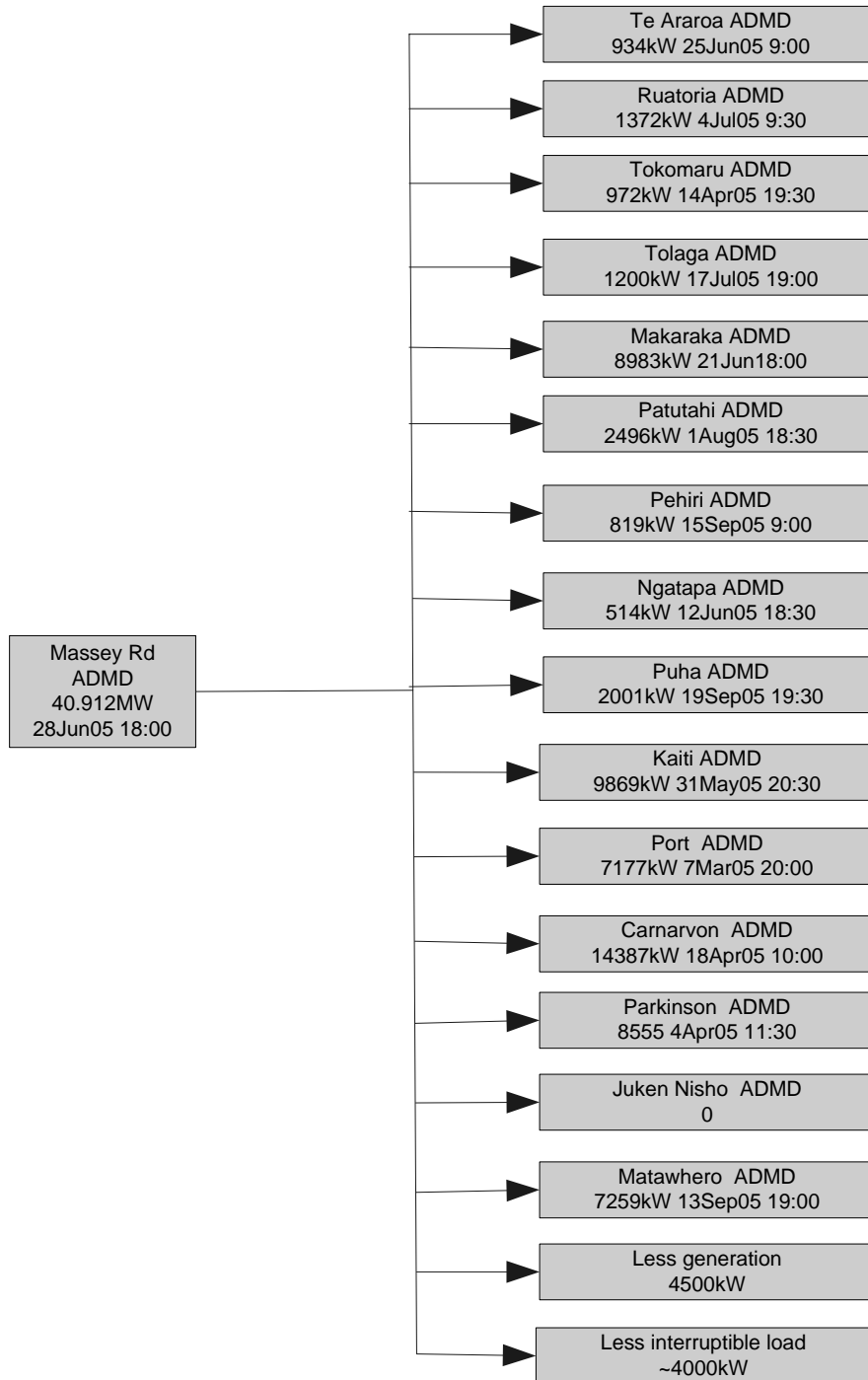

4.3.1.2 Wairoa

ENL’s current after diversity maximum demand (ADMD) at Wairoa GXP is 9.376MW and for the Tuai GXP is 0.622MW, which is disaggregated in Figure 4.3.1.2(a).

Figure 4.3.1.2(a) – Wairoa Region Maximum Demand

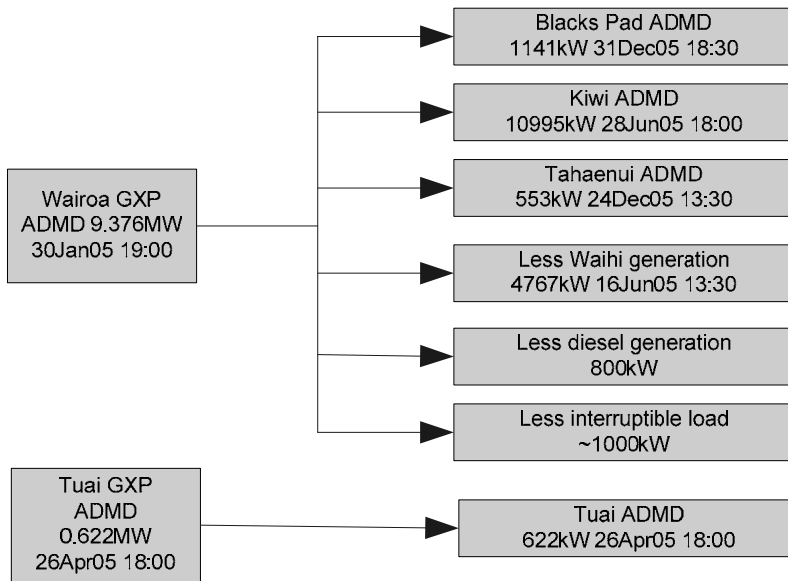

The system demand figures excluding embedded generation are-

Gisborne Region	44.844MW	28 June 2005 18:00
Wairoa Region	11.665MW	16 December 2005 23:00
System Total	55.894MW	28 June 2005 18:00

4.3.2 Drivers of future demand

Key drivers of demand growth (and contraction) are likely to include the issues depicted in Figure 4.3.2(a) below.

Figure 4.3.2(a) – Drivers of demand

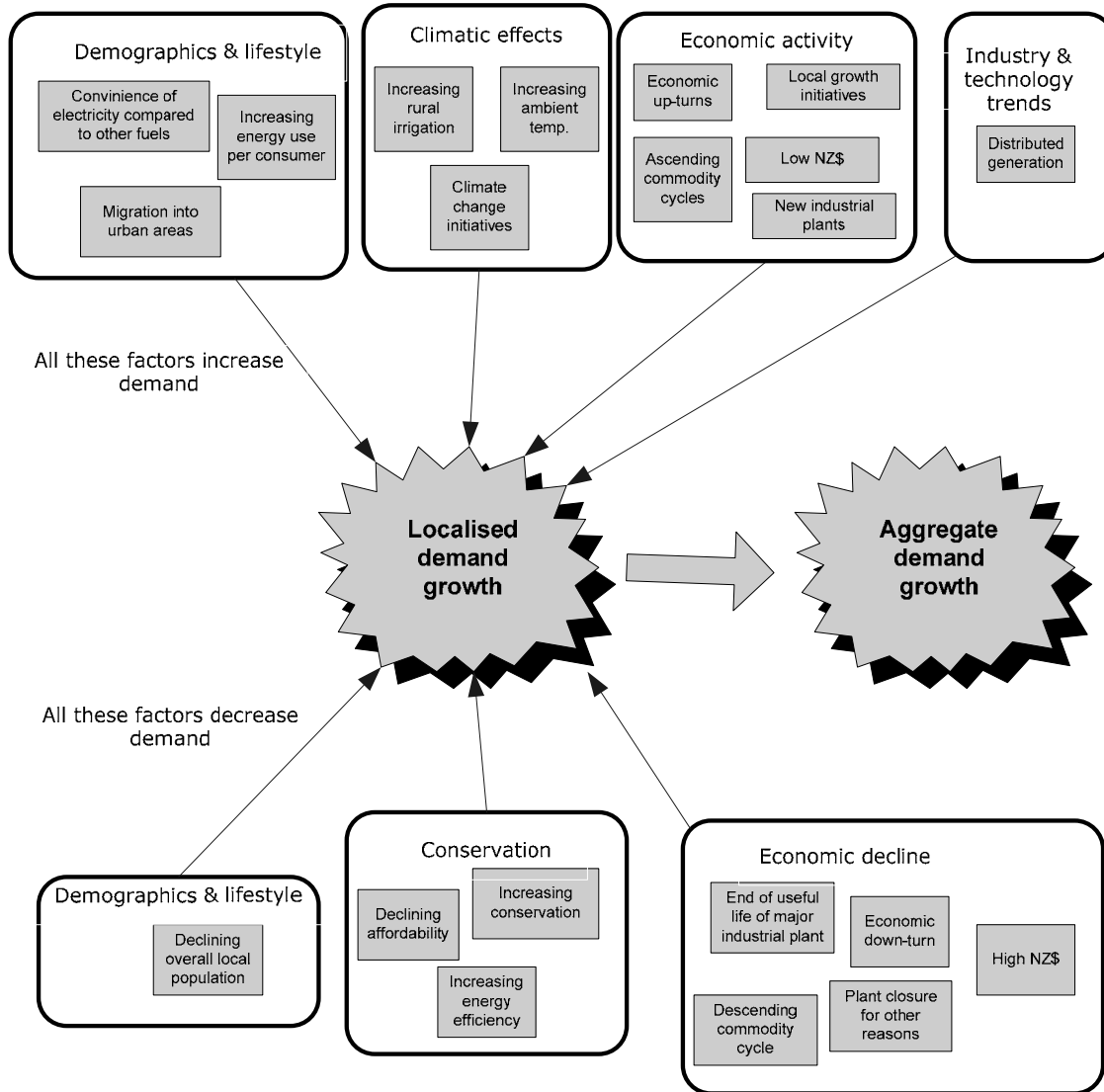

At a localised level (11kV feeder) one or two of these issues will generally predominate, will be predictable and manageable, and can be aggregated into a reasonably reliable feeder demand forecast. The precise estimates of future demand are very detailed, and are described in section 4.3.3 below.

The following section examine in detail what ENL believes will be the most significant drivers of its network capacity and configuration over the next 15 to 20 years...

4.3.2.1 Maturing forestry

Expected processing volumes

A very large increase in forest harvesting is predicted for the East Coast area. The Ministry of Agriculture and Forestry's *National Exotic Forest Description 2000* provides forecasts of the total recoverable volume of logs through to 2040. Current log volumes are expected to approximately triple to around 2.5 million m³ within 5 years, and increase still further to around 3.5 million m³ approximately 10 years after that.

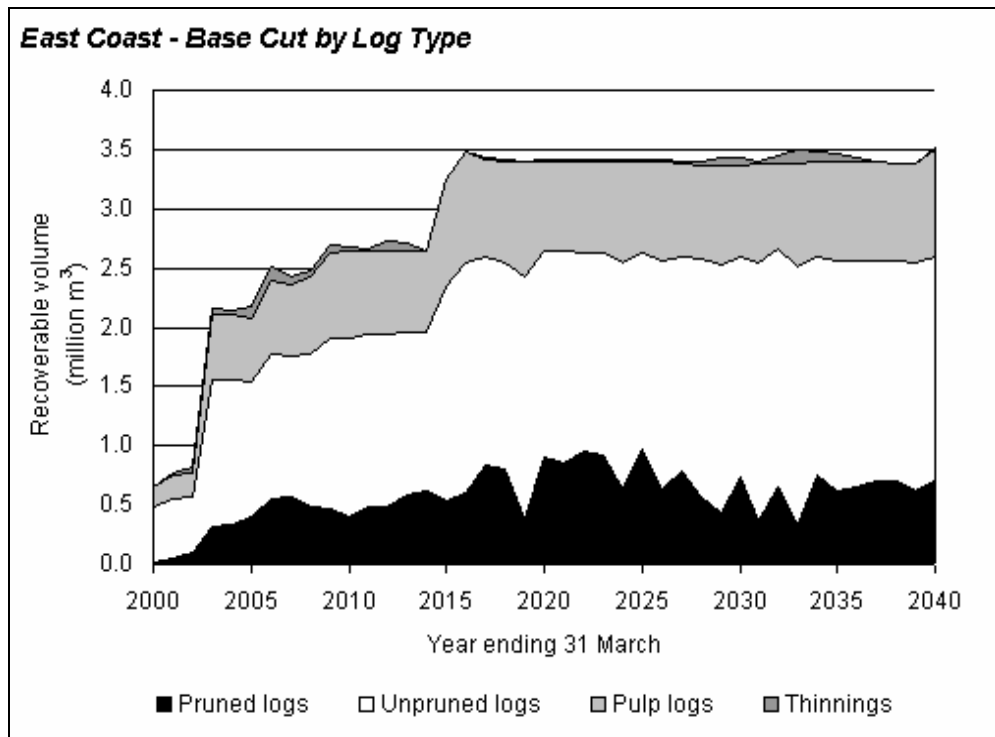

Source - National Exotic Forest Description: National and Regional Wood Supply Forecasts 2000

Likely distribution requirements

The existing JNL mill can be expanded to accommodate approximately 36% additional throughput but beyond that additional harvest volumes will require additional mills. This forecast growth in harvest would require at least two additional mills by 2010 and one further mill by 2015 on the assumption that the ratio of raw log exports to the total harvest volume remains approximately the same. Further mills may also be required, including less energy-efficient smaller mills. Like the existing JNL plant, a large mill would probably have a combined heat & power (“CHP”) unit fuelled primarily by waste wood and boosted by gas to deliver the larger part of its gross energy requirements.

Hence the electricity load requirements associated with two new plants in close proximity would be between 7 to 10 MW if they are similar to

the existing JNL mill. The network around Matawhero (where processing plants are most likely to locate) will therefore need to supply about an additional 10 MW by 2010.

Likely sub-transmission requirements

Impacts on the sub-transmission network would of course be greater and reflect the aggregated regional load increase, perhaps in the order of 25 to 30MW by 2016. This additional demand could be minimised through embedded CHP plants exporting surplus power to the distribution network.

Knock-on community economic growth

The Tarawhiti Development Taskforce report estimates that forest harvesting and processing could generate 15,000 – 20,000 additional jobs in the region. Additional connections and community prosperity would be almost certain to drive increased domestic consumption.

Possible investment risks

On a final note, the regional benefits and anticipated increases in load will be limited if most logs are exported unprocessed, and this constitutes a real investment risk to ENL given that historically the New Zealand forestry sector has exported raw logs.

4.3.2.2 Regional natural gas reserves

Undeveloped gas resources existing in the region could be a source of relatively cheap electricity generation in the Gisborne and Wairoa regions and radically alter net power flows. New gas-fired generation could also significantly reduce net power imports at Massey Rd. Given the high costs of augmenting the double circuit 110kV line supplying Massey Rd or the Vector high-pressure gas main from Opotiki, local gas supplying local generation could provide cheap and stably-priced electricity. ENL notes that the current EIRA 1998, EIRAA 2001 and EIRAA 2004 prohibitions on lines companies being practically involved in generation are the sole barrier to us providing cheap reliable electricity to ENL's consumers.

4.3.2.3 Changes In Technology

Advances in generation technology that replace the need for network capacity are already emerging and will almost certainly be a

commercial reality by 2016. The need for investment in network assets with an economic 40 year life (but a practical life of about 70 years) is therefore clearly subject to challenge. This is particularly true of capacity investment in the remote rural network, where small scale distributed generation is potentially a more economic alternative.

Transmission and distribution lines exist for the sole purpose of transporting electricity from where it is generated to where loads are located. Logically, if generation could be moved closer to loads, then there would be less need for transmission and distribution. In this sense, new generation “competes” with electricity lines businesses/investments. This is particularly true of distributed generation (and direct substitutes such as direct solar water heating). Larger embedded generation plants are less of a threat for distribution networks, but pose a significant risk of bypass for transmission networks. These technologies can also be used as substitutes for network upgrades.

Potential new generation around Gisborne includes new biomass generation to accompany additional forestry mills, larger biomass plant(s) that would produce more power than required by the mills, gas generation plant to take advantage of surplus capacity in the Vector pipeline or new gas discoveries, small gas turbines and hydro that could be operated as peaking plant to reduce peak demand, and other renewables such as the high wind and solar resources in the region.

ENL has the opportunity to use embedded and distributed generation to reduce the need for transmission and distribution upgrades, and can also re-engineer its network during the current upgrade program so that it is more suitable for a distributed generation environment. These issues are the subjects of a development strategy in preparation to minimise investment risk and lower electricity supply costs.

4.3.3 Estimated zone sub demands

As outlined in detail in the remainder of section 4, ENL expects its future demand to vary from the current demand as follows...

- A moderate to high rate of growth within the existing network footprint in the Kaiti / Port area, the Gisborne industrial estate and the Mahia Peninsula.

- A very high rate of growth within or very close to the existing network footprint at Matawhero if the impending forest harvest is processed locally.
- A low rate of growth along the east coast north of Gisborne.
- Possible contraction of demand in the rural parts of the Wairoa District other than Mahia.

ENL’s collective experience strongly indicates that it would be rare to ever get more than a few months confirmation (sufficient to justify significant investment) of definite changes in an existing or new major consumers demand. This is because most of these consumers operate in fast-moving consumer markets and often make capital investment decisions quickly themselves, and they generally keep such decisions confidential until the latest possible moment. Probably the best that ENL can do is to identify in advance where the network has sufficient surplus capacity to supply a large chunk of load, but as experience shows industrial location decisions rarely if ever consider the location of energy supply – they tend to be driven more by land-use restrictions, raw material supply and transport infrastructure.

This section examines each of ENL’s zone substations at a feeder level in regard to the issues identified above and provides a 10 year projection of demand for each sub and what provision for growth if any is required.

4.3.3.1 Gisborne Region

Carnarvon St

Feeder	Rate & nature of growth	Provision for growth
Aberdeen	Typical domestic commercial mix Medium	None required
Anzac	Typical domestic commercial mix Medium	None required
Awapuni	Typical domestic commercial mix Medium	None required
Childers	Typical domestic commercial mix Medium	None required other than for security
City	Swings in growth due to cyclic prosperity in CBD	None required other than for security
Gladstone	Typical domestic commercial mix Medium	None required other than for security
Kahutia	Swings in growth due to cyclic prosperity in CBD	None required
Palmerston	Typical domestic commercial mix	None required other than for security

	Medium	
Watties	Commercial subject to lumpy change	None required
Sub	High, less lumpy than industrial subs but still dependent on retail cycles. Likely to exhibit load shifts between feeders.	None required – projected 10 year load is expected to be only 65% of capacity.

JNL

Feeder	Rate & nature of growth	Provision for growth
JNL	Large step changes Moderate	Non required
Matawhero Tie	Provides for security only	Non required
Sub	Moderate	New installation non required

Kaiti

Feeder	Rate & nature of growth	Provision for growth
Dalton	Domestic Medium	Non required
Delatour	Domestic load increases rather than new load	Recently upgraded Non required
Hershell	Domestic Medium	Non required rationalised with port
Tamarau	Domestic Medium	Non required rationalised with port
Wainui	Domestic Medium	Recently upgraded Non required
Whangara	Domestic Rural Low to Medium	Growth constrained intermediate zone sub considered
Sub	Moderate, reasonably diverse and predictable as this is largely domestic.	Projected 10 year load is expected to be about 95% of capacity, Expect to off-load 3MW or 4MW to Port.

Makaraka

Feeder	Rate & nature of growth	Provision for growth
Bushmere	Lifestyle Rural medium	Built 2002 with provision for planning period
Campion	Lifestyle domestic High	Built 2002 with provision for planning period
Haisman	Lifestyle domestic High	Built 2002 with provision for planning period
Nelson	Lifestyle domestic High	Built 2002 with provision for planning period
Sub	High	Projected 10 year load just exceeds 100% of capacity. Off-loading 2MW or 3MW to Patutahi is an option.

Matawhero

Feeder	Rate & nature of growth	Provision for growth
--------	-------------------------	----------------------

Bell	Industrial Rural medium	None required
Dunstan	Industrial Rural medium	None required
JNL A	Security Tie	None planned
Manutuke	Industrial load new load forecast	Requirements under consultation Unknown
Waipoa	Industrial load new load forecast	Requirements under consultation Unknown
Sub	Very high	Projected 10 year load is expected to be 85% of capacity. Offset by and secures JNL sub.

Ngatapa

Feeder	Rate & nature of growth	Provision for growth
Ngatapa	Rural minimal	Upgrade for security an option
Taharoa	Rural minimal	Upgrade for security planned
Totangi	Rural minimal	None planned
Sub	Low, vulnerable to single large load being a high percent of existing surplus capacity.	Security Provision planned – projected 10 year load is expected to be only 60% of capacity under existing normal conditions

Parkinson

Feeder	Rate & nature of growth	Provision for growth
Cedenco	Industrial High	No needs identified
Chalmers	Domestic Medium	None required
Elgin	Domestic Medium	None required
Innes	Industrial Steady but Lumpy increases	No needs identified
Lytton	Domestic Medium	None required
Solandis	Domestic Medium	None required
Willows	Security Tie Low	No needs identified
Sub	High, potentially lumpy and uncertain due to medium sized industrial loads.	None required – projected 10 year load is expected to only be 65% of capacity.

Patutahi

Feeder	Rate & nature of growth	Provision for growth
Lavenham	Rural Mix Medium	None required
Muriwai	Rural Mix Medium	None required
Te Ari	Rural Mix Medium with large load	No needs identified
Waimata	Rural Mix Medium	None required
Sub	Moderate.	None required – projected 10 year load is expected to be only 33% of capacity. Could take about 3MW of load from Makaraka and Matawhero if necessary.

Pehiri

Feeder	Rate & nature of growth	Provision for growth
Parikania	Rural Mix Medium	None required
Tahunga	Rural minimal Rural Mix Medium	None required
Tiniroto	Rural Mix Medium	None required
Warenga	Rural minimal	None required
Sub	Low.	None required – projected 10 year load is expected to be only 30% of capacity.

Port

Feeder	Rate & nature of growth	Provision for growth
Crawford	Domestic Medium	None required
Esplanade	Commercaill load new load forecast	None required
Harris	Domestic Medium	None required
Port	Industrial load new load forecast	None required
Sub	Moderate.	None required – projected 10 year load is expected to be only 15% of capacity, so there is scope to shift about 9MW on to Port from Kaiti or Carnarvon.

Puha

Feeder	Rate & nature of growth	Provision for growth
Kanikania	Rural growth generally low. Small increases significant in terms of total load one significant load at end of line.	None Required
Matawai	Stable Township no growth	None Required
Te Karaka	Stable township possible decrease offset by outlying lifestyle blocks	None Required
Whatatutu	Rural growth generally low. Small increases significant in terms of total load	None Required
Sub	Moderate.	None required – projected 10 year load is expected to be only 45% of capacity.

Ruatoria

Feeder	Rate & nature of growth	Provision for growth
Makariaka	Rural growth generally low. Small increases significant in terms of total load	None Required However security support limited.
Ruatoria	Stable Township. Growing slowly	None Required
Tikitiki	Rural growth generally low. Small increases significant in terms of total load	None Required
Sub	Low.	None required – projected 10 year load is

		expected to be only 33% of capacity.
--	--	--------------------------------------

Te Araroa

Feeder	Rate & nature of growth	Provision for growth
Awatere	Rural growth generally low. Small increases significant in terms of total load	None Required
Hicks	Rural growth generally low. Small increases significant in terms of total load	None Required
Te Araroa	Stable Township	None Required
Sub	Low, vulnerable to single large load being a high percent of existing surplus capacity.	None required – projected 10 year load is expected to be only 35% of capacity.

Tokomaru Bay

Feeder	Rate & nature of growth	Provision for growth
Inland	Rural growth generally low. Small increases significant in terms of total load	None Required however security support necessary.
Mata	Rural growth generally low. Small increases significant in terms of total load	None Required however security support necessary.
Seaside	Rural growth generally low. Small increases significant in terms of total load	None Required
Sub	Low, vulnerable to single large load being a high percent of existing surplus capacity.	None required – projected 10 year load is expected to be only 45% of capacity.

Tolaga Bay

Feeder	Rate & nature of growth	Provision for growth
Rototahi	Rural growth generally low. Small increases significant in terms of total load	None Required
Tauwhare	Rural growth generally low. Small increases significant in terms of total load	None Required
Tokitie	Rural growth generally low. Small increases significant in terms of total load	None Required however security support necessary.
Town		
Sub	Low.	None required – projected 10 year load is expected to be only 37% of capacity.

4.3.3.2 Wairoa Reigon

Blacks Pad

Feeder	Rate & nature of growth	Provision for growth
Sub and feeder	High, spread amongst life-style blocks, holiday homes and dairy conversions. Holiday homes add a peaky aspect to the load which makes recovery of investment awkward.	Already using one 1MWe diesel generator to support both load and voltage. First step to provide additional network capacity has been to move Blacks Pad closer to the Mahia load, next step will be install a larger 33/11kV transformer.

Kiwi

Feeder	Rate & nature of growth	Provision for growth
AFFCO	Unpredictable	At limit
Borough 1	Medium Growth Township	Approaching secure limit
Borough 2	Medium Growth Township with industry	Approaching secure limit
Brickworks	Little if any	Voltage constrained at far end, so any remote growth would require either re-conductoring or adopting of 22kV.
Kiwi A	Incomer	At capacity 33kV upgrade necessary
Kiwi B	Incomer	At capacity 33kV upgrade necessary
Kiwi C	Incomer	At capacity 33kV upgrade necessary
Nuhaka	Little if any	Voltage constrained at far end, so any remote growth would require either re-conductoring or adopting of 22kV.
Waihi	Generator no increase expected	None Required
Sub	Likely growth is almost totally big industrial and therefore lumpy and difficult to forecast.	Transformer required in future

Tahaenui

Feeder	Rate & nature of growth	Provision for growth
Sub and feeder	Minimal if any growth. Load can peak if used to back feed Blacks Pad or the Nuhaka feeder.	None required

Tuai GXP

Feeder	Rate & nature of growth	Provision for growth
Lake	Little if any	None required
Ruatikuri	Little if any	Distance main issue Voltage regulator or capacitors beyond current planning period
Sub	Minimal if any.	Non required. Option of relinquishing Transpower supply and taking supply from the Tuai generation bus does not present any growth constraints.

Waihi

Feeder	Rate & nature of growth	Provision for growth
Sub	Nil – takes injected generation from Waihi hydro.	None required.

4.3.4 Estimated demand aggregated to GXP level

4.3.4.1 Gisborne Region

Sub.	Rate & nature of growth	Provision for growth
Carnarvon	High, less lumpy than industrial subs but still dependent on retail cycles. Likely to exhibit load shifts between feeders.	None required – projected 10 year load is expected to be only 65% of capacity.
JNL		
Kaiti	Moderate, reasonably diverse and predictable as this is largely domestic.	Projected 10 year load is expected to be about 95% of capacity, so expect to off-load 3MW or 4MW to Port.
Makaraka	High	Projected 10 year load just exceeds 100% of capacity. Off-loading 3MW or 4MW to Patutahi would be a key option.
Matawhero	Very high	Projected 10 year load is expected to be 85% of capacity. JNL new sub
Ngatapa	Low, vulnerable to single large load being a high percent of existing surplus capacity.	None required – projected 10 year load is expected to be only 60% of capacity.
Parkinson	High, potentially lumpy and uncertain due to medium sized industrial loads.	None required – projected 10 year load is expected to only be 65% of capacity.
Patutahi	Moderate.	None required – projected 10 year load is expected to be only 33% of capacity. Could take about 6MW of load from Makaraka and Matawhero if necessary.
Pehiri	Low.	None required – projected 10 year load is expected to be only 30% of capacity.
Port	Moderate.	None required – projected 10 year load is expected to be only 15% of capacity, so there is scope to shift about 9MW on to Port from Kaiti or Carnarvon.
Puha	Moderate.	None required – projected 10 year load is expected to be only 45% of capacity.
Ruatoria	Low.	None required – projected 10 year load is

		expected to be only 33% of capacity.
Te Araroa	Low, vulnerable to single large load being a high percent of existing surplus capacity.	None required – projected 10 year load is expected to be only 35% of capacity.
Tokomaru	Low, vulnerable to single large load being a high percent of existing surplus capacity.	None required – projected 10 year load is expected to be only 45% of capacity.
Tolaga	Low.	None required – projected 10 year load is expected to be only 37% of capacity.
GXP	High, expected to double by 2020	Need another 110kV circuit from Tuai to provide (n-1) security at current demand, and will require a second additional 110kV circuit to meet demand growth. Would be useful to build a new GXP near Matawhero or Makaraka instead of terminating any new lines at Massey Rd.

4.3.4.2 Wairoa Region

Sub.	Rate & nature of growth	Provision for growth
Blacks Pad	High, spread amongst life-style blocks, holiday homes and dairy conversions. Holiday homes add a peaky aspect to the load which makes recovery of investment awkward.	Already using one 1MWe diesel generator to support both load and voltage. First step to provide additional network capacity has been to move Blacks Pad closer to the Mahia load, next step will be install a larger 33/11kV transformer.
Kiwi	Likely growth is almost totally big industrial and therefore lumpy and difficult to forecast.	Additional growth complication is that the Nuhaka - Frasertown and Brickworks - Raupunga feeders are very long (and hence voltage constrained) so any significant load growth on either of these feeders would require 11kV reinforcement as well as augmenting Kiwi.
Tahaenui	Minimal if any growth. Load can peak if used to back-feed Blacks Pad or the Nuhaka feeder.	Non required.
Waihi	Nil – takes injected generation from Waihi hydro.	None required.
Wairoa GXP	Likely growth is almost totally big industrial and therefore lumpy and difficult to forecast.	Will ultimately require upgrade to 110/33kV
Tuai GXP	Minimal if any.	Non required. Option of relinquishing Transpower supply and taking supply from the Tuai generation bus does not present any growth constraints.

4.3.4.2 Zone Substation Growth

Zone substation capacities and present loads are shown in the following table. The loads shown are half hour maximum 2005/06 demands with normal load control policy in effect. Reductions at some sites compared with previous years are caused by imbedded generation reducing the burden on the Zone substation Transformer assets. As the expected life of the generation assets is shorter than that of the Transformer assets and the reliability/availability is lower the capacity of the transformers is set to provide for peak demands should the generators be unavailable.

Forecast peak power demands for the installed transformer capacity by the end of the planning period are also indicated.

Growth forecasts have been averaged on a 10-year prediction to smooth out step increments introduced by new loads.

Substation	Transformer Capacity (MVA)	Maximum 2005/06 (MW)	%of Installed Capacity	Growth (%)	Load 2018 (MW)	%of Installed Capacity
TE ARAROA	1 x 2.5	0.93	37%	1%	1.04	42%
RUATORIA (5/7MVA)	1 x 5.0/7.5	1.37	27%	1%	1.53	31%
TOKOMARU	1 x 2.5	0.97	39%	1%	1.08	43%
TOLAGA	1 x 5.0	1.20	24%	4%	1.64	33%
KAITI	1 x 12.5	9.80	82%	2%	12.19	102%
PORT	1 x 12.5	7.17	60%	2%	8.91	74%
CARNARVON	1 x 12.5, 1 x 12.75	14.30	60%	3%	18.67	78%
PARKINSON	2 x 12.5	8.55	71%	4%	11.71	98%
MAKARAKA	1 x 12.75	8.98	75%	3%	11.72	98%
PATUTAHI	2 x 5.0	2.49	25%	2%	3.10	31%
PEHIRI	1 x 2.5	0.82	32%	1%	9.14	36%
NGATAPA	2 x 0.5	0.51	51%	1%	5.73	57%
PUHA	1 x 5.0	2.00	40%	2%	2.49	50%
JNL	1 x 12.75	0.00	0%	5%	6.52	50%

Substation	Transformer Capacity (MVA)	Maximum 2005/06 (MW)	% of Installed Capacity	Growth (%)	Load 2018 (MW)	% of Installed Capacity
MATAWHERO (5/7MVA)	2 x 5.0/7.5	7.20	72%	2%	8.95	90%
TUAI		0.62	0%	0%	0.62	-
KIWI		11.00	-	2%	13.68	-
BLACKS PAD	1 x 1.5 (33/11)	1.14	76%	7%	2.40	160%
TAHAENUI	1 x 1.5 (33/11)	0.53	36%	2%	0.66	44%

4.3.5 Overall System Growth

By projecting growth trends forward, coincident system peak demand has been forecast to grow from 56 MW in 2005/06 to 75 MW by the horizon year, 2018. The moderate overall growth rate of approximately 2% reflects anticipated levels of economic activity in the Eastland Region.

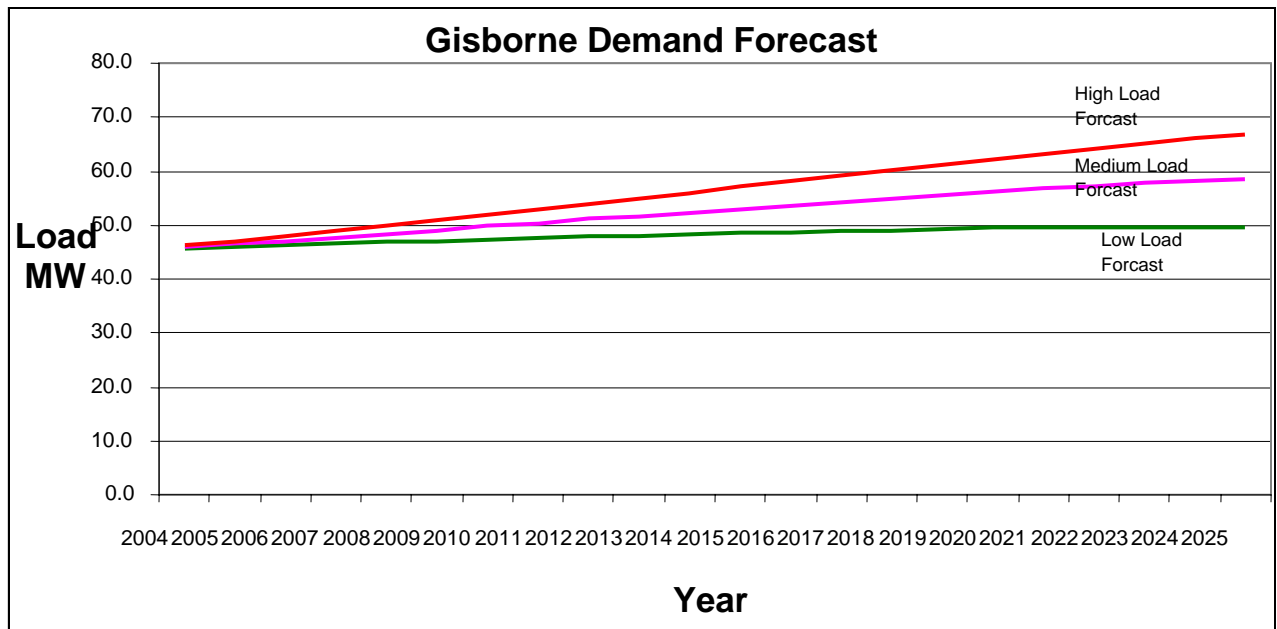

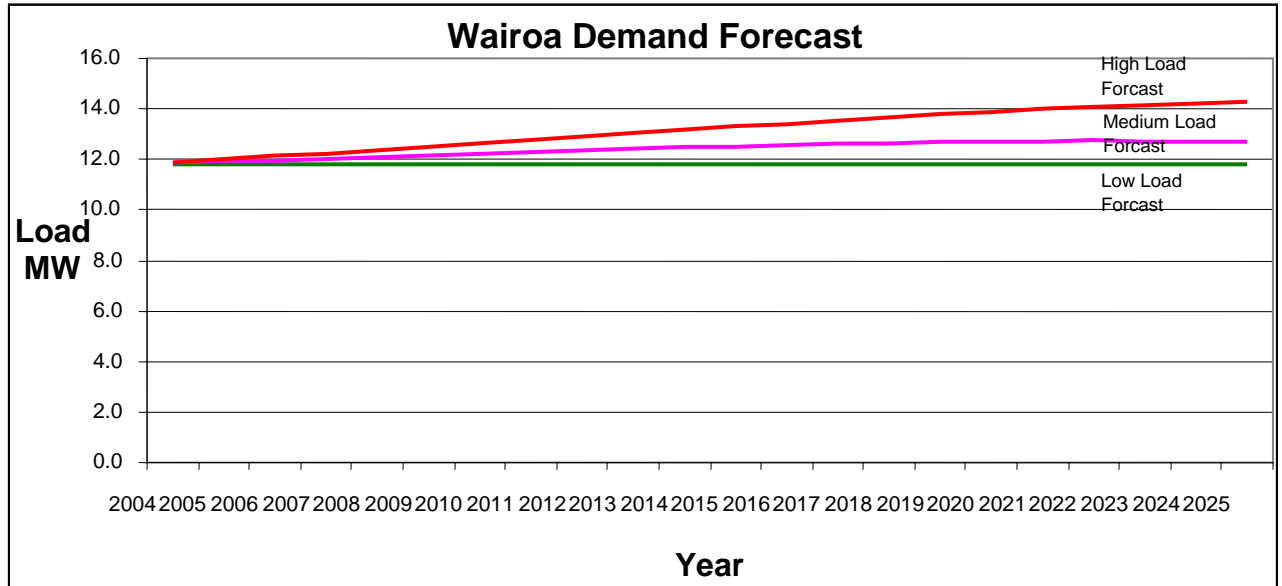

While the forecast demand growth trends are in the order of 2% p.a. the historical trend does not reflect this largely due to changing factors such as load control strategies, and past energy saving drives arising out of national energy shortages.

4.3.6 Forecast Accuracy and Variations

ENL has used a Load Forecasting Model to help predict the impact of accumulated load growth on its capacity requirements and security standards. The model allows scenario planning for investigating the impact of large loads associated with new processing plants and other industrial loads when applied at specific locations in the network.

The model achieves this via the following method...

- Profile Builder: Feeder load data is obtained from the SCADA system. Load profiles are created for domestic, non-domestic, and specific industrial consumers and reconciled so that they sum to known feeder level data. Zone substation, sub transmission line, and GXP profiles can then be built up which take into account diversity.
- Load Forecasting: The number of connections and an assumed annual growth rate can vary each profile for each class of consumer.

- Scenario planner: Large loads and generation can be inserted at any sub-transmission node. i.e. Zone substation. Resulting loads and their profile can be applied to PSSU load flow analysis to determine voltage, loss and security issues.

ENL has also considered historical and national trends and has found that they provide the most effective method for load forecasting. Consideration is made of regional developments via use of the Load model however past experience has shown that load forecasts provided by end users do not take diversity into account. Only a small proportion of the developments eventuate and in general the forecasts have proven to be inaccurate.

All demand forecasts are subject to variation as a result of externalities such as weather and economic growth. Annual variations in these factors will create demand variations in the short term, whilst sustained trends are likely to cause more persistent departures from the forecast.

Varying the timing of planned work can accommodate forecast variances. Lower than expected load growth can be accommodated by deferral and faster than expected load growth by acceleration. Adequate notice is generally available for the type of work involved to undertake such acceleration, although major items of equipment can have long lead times and constrain the extent to which work can be performed 'just in time'. ENL's basis for network planning and operations is sufficiently rigorous and conservative to avoid serious capacity shortages and un-served demand.

ENL does not manage the transmission system planning. When presented with a transmission issue by Transpower ENL assesses opportunity for alternative investments that deliver lower cost. Responsibility for delivery of transmission capacity and security and the associated investment risks belong to Transpower.

4.3.7 Issues arising from estimated demand

The only confirmed issue arising from the estimated demand is the probable increase in demand around Matawhero as the impending

forestry harvest is processed. As outlined in section 4.3.2.1 ENL expects to supply between 7MW and 10MW of additional demand by 2010 and possibly a further 5MW by 2016.

4.4 Where are the capacity constraints

4.4.1 Bulk supply constraints

At Tuai the 110kV lines supplying ENL are connected to a ring bus via a circuit breaker that is not equipped with bus protection. Hence any fault on the 110kV bus at Tuai or failure of a double circuit 110kV tower will interrupt the entire supply.

Gisborne Point of Supply

The Gisborne Transpower Grid Exit Point, (GXP) and the 110kV line from Tuai currently do not meet ENL's security standard. Further with only an approximate 14MW of normal/full delivery capacity margin existing at the Gisborne GXP, ENL's standard of carrying 10MW of excess capacity at key locations in its network to cover the lead time required to provide capacity for a large load increase, (e.g a timber processing plant) is close to being exceeded. As load grows the security and capacity levels associated with the Gisborne GXP will continue to diverge from the standards.

Delivery of capacity at the Gisborne GXP 50kV Bus is determined by the existing ratings of the following key plant;

<u>Plant</u>	<u>MVA Rating</u>
	<i>Lines = summer / winter</i>
	<i>Transformers / Bus = max continuous / summer post contingency / winter post contingency</i>
GIS TUI 1	49 / 60
GIS TUI 2	49 / 60
T3	30 / 37 / 39
T4	30 / 37 / 39
50kV Bus	30 / 34 / 34

Current constraints are due to;

- The existing normal/contingency, (both lines in service/one line in service) capacity of the Tuai 110kv line is 65/49MW. The ratings of the line are constrained to less than the thermal limits of the line due to the Gisborne GXP transformers not being fitted with on load tap changers, (OLTC). Hence the line constraints are determined by the requirement to maintain the voltage on the GXP Bus to 0.95pu so as to maintain an acceptable 50kV voltage. (It should be noted that 12MVAR of capacitance is already installed on the 110kv bus to compensate for voltage drop).
- The existing normal/contingency capacity of the 2x Gisborne 110/50kV transformers is 60/37MW. The transformer constraint is determined by the thermal ratings of the transformer units.
- The 50kV Bus has a max continuous/post contingency thermal rating of 30/34MW.

Based on the existing ratings it is considered that the Gisborne GXP is limited by the 34 MW contingent capacity of the 50kV Bus.

Currently without the benefit of load control and the operation of diesel peaking plants the maximum demand peak at the Gisborne GXP is estimated to be 46MW. (With load control and peaking plant operation the GXP maximum demand is approximately 40MW). In terms of the standard transmission security criteria this means that Transpower need only provide 34MW of capacity for the first 3 hours during a contingent event occurring during a peak loading period. This would result in ENL having to disconnect load on a rationing basis.

While the probability of a fault happening at maximum peak load and lasting more than 3 hours is small the Load Duration profile indicates the maximum demand at the Gisborne GXP exceeds 34MW for 21% of the year.

Analysis of the current Gisborne GXP load profile indicates that a contingent capacity of 39MW is required to meet the criteria of not exceeding the contingent capacity by not more than 10% of the year. Hence with the Gisborne GXP contingent capacity currently at 34MW this means currently a 5MW constraint exists.

This constraint is being addressed by the Gisborne GXP Transformer upgrade

4.4.2 Sub-transmission constraints

ENL's only sub-transmission constraint is the Mahia 33kV line which is currently limited to 1.5MW. Following the 33kV extension project the limit will be 2.8MW.

4.4.3 Distribution constraints

In ENL's overhead network the constraint is generally driven by voltage drop. A design standard of 2.0% maximum is applied to new lines and permitted to reach to 5% before reinforcement is considered. Other factors such as the need for contingent capacity to meet security needs are also considered.

Cable network tends to be more constrained by thermal ratings. Therefore underground systems are less tolerant of constraints.

ENL has identified the following distribution constraints...

- Frasertown and Raupunga feeder's remote connections are currently limited by voltage. This will preclude all new load other than isolated single dwellings.
- Muriwai feeder can only supply around an additional 200kVA of load, up to halfway along the feeder otherwise the voltage would be unacceptably low.
- Anarua Bay feeder is voltage constrained over holiday periods. Hence only isolated new loads could be supplied.
- Matawai feeder is voltage constrained. Additional load would require a voltage regulator and ultimately a 50/11kV zone substation.

Relief of all of these constraints may require significant customer contribution as the required investment is unlikely to be covered by the allowable revenue.

4.4.4 Significant consumer constraints

In general significant consumers have supplies tailored to their requirements. Consumers requiring increases in capacity are effectively constrained by the minimum investment they initially undertook.

4.5 Use of non-asset solutions

As discussed in section 4.2.1 ENL routinely considers a range of non-asset solutions, and indeed ENL's preference is for solutions that avoid or defer new investment.

4.6 Policies for distributed generation

ENL clearly recognises the value of distributed generation in the following ways...

- Reduction of peak demand at Transpower GXP's.
- Reducing the effect of existing network constraints.
- Avoiding investment in additional network capacity.
- Making at least a small contribution to supply security.
- Making better use of local primary energy resources thereby avoiding line losses.
- Avoiding the environmental impact associated with large scale power generation.
- Contributing to supply of customers on marginal lines post-2013.

However ENL also recognises that distributed generation can have the following undesirable effects...

- Increased fault levels, requiring protection and switchgear upgrades.
- Increased line losses if surplus energy is exported through a network constraint.
- Stranding of assets, or at least of part of an assets capacity.
- Reduction in asset utilization without the ability to remove the asset
- Instability of the network during faults and voltage control issues.

Despite the potential undesirable effects, ENL actively encourages the development of distributed generation that will benefit both the generator and ENL. The key requirements for those wishing to connect distributed generation to the network broadly fall under the following headings.

Connection terms & conditions (commercial)

- Connection of distributed generation up to 10kW to an existing connection will not incur any additional line charges. Connection of distributed generation greater than 10kW to an existing connection may incur additional costs to reflect network reinforcement which can be either on a full, up-front basis or over time. Costs charged under either method are likely to be capped by Regulation.
- Distributed generation that requires a new connection to the network will be charged a standard connection fee, and may also be charged a fee to reflect reinforcement of the network back to the next transformation point.
- An annual administration fee will be payable by the connecting party to ENL.
- Installation of suitable metering (refer to technical standards below) shall be at the expense of the distributed generator and its associated energy retailer.
- ENL is happy to recognise and share the benefits of distributed generation that arise from reducing ENL's costs (such as transmission costs, or deferred investment in the network) provided the distributed generation is of sufficient size to provide real benefits.
- Those wishing to connect distributed generation must satisfy ENL that a contractual arrangement with a suitable party is in place to consume all injected energy.

Safety standards

- A party connecting distributed generation must comply with any and all safety requirements promulgated by ENL.
- ENL reserves the right to physically disconnect any distributed generation that does not comply with such requirements.

Technical standards

- Metering capable of recording both imported and exported energy must be installed. If the owner of the distributed generation wishes to share in any benefits accruing to ENL, such metering may need to be half-hourly.
- ENL may require a distributed generator of greater than 10kW to demonstrate that operation of the distributed generation will not interfere with operational aspects of the network, particularly such aspects as protection and control.
- All connection assets must be designed and constructed to technical standards not dissimilar to ENL's own prevailing asset management standards.

4.7 Development program

4.7.1 Options considered for major initiatives

4.7.1.1 Transmission Development

Gisborne Point of Supply

To provide for ENL's security standards, relieve current capacity constraint and meet future load growth, the total capacity of the Gisborne GXP is required to be increased. Even in the event of significant generation being installed on the ENL network, for the provision of contingent security, the capacity of the Gisborne GXP is still required to be increased.

The options available which will incrementally increase the transmission capacity to Gisborne are;

a. Transformer Upgrade at Gisborne GXP

Upgrading the current 30MVA transformers to 2x 60 MVA units fitted with OLTCs increases the normal/contingent capacity of the GXP to 120/75MW. The voltage correction provided by the OLTCs increases the normal/contingent capacity of the 110kV lines to 88/49MW. Hence the line becomes the item of constraint and the GXP has a contingent capacity of 49MW.

Coinciding with the transformer upgrade project the thermal rating of the 50kV bus would be increased to 60MW. Also neutral earthing resistors, (NERs) would be installed to limit single phase to earth fault current there by mitigating a current ENL compliance issue regarding possible induction to telecommunication equipment during 50kV sub-transmission faults.

ENL has entered into a New Investment Contract with Transpower for the upgrading of the Gisborne GXP as described above. The construction cost of the upgrade is \$4.5mill and completion is scheduled for late 2006/07.

The term of the Investment Contract is 25 years with repayment costs being passed directly through as part of the transmission portion of line function service charges. Accordingly expenditure for the Gisborne GXP upgrade is not included in the financial projections provided in Section 7.3.1.

b. 110kV Line Thermal Upgrade

Medium load forecasts for the Gisborne GXP predict that the 110kV lines summer contingent capacity becomes a constraint in 2009.

Transpower has advised that they are currently carrying out an investigation into improving the summer thermal rating of the line to 60 MW. At this time no information is available regarding the practicalities or cost of achieving this.

However, assuming that it is possible to improve the thermal rating of the line, then the contingent capacity of the Gisborne GXP is increased to 60MW.

Previous graphs shows that a contingent capacity of 60MW will under a medium growth scenario become constrained in approximately 2030 and 2020 under a high growth scenario. (Again it should be noted that the deferral of demand growth through network connected generation has not been considered).

c. Third transmission Line

As a potential solution to the eventual 60MW constraint, Transpower has been requested to investigate the possibility of re-conductoring the Tuai – Gisborne 110kV line and installing additional transformer capacity, (a 3rd 60MVA transformer) at the Gisborne GXP. Estimated costs of the re-conductor work and additional transformer capacity are \$10 to \$20mill.

It is expected that this solution will not be optimum as the ENL sub-transmission network supplied from the Gisborne GXP will have become constrained. Being installed in predominantly urban areas means that these constraints will not easily be resolved through enhancement of, or additions to the existing sub-transmission lines also consenting issues will be significant.

The construction of a third transmission line from Tuai is therefore proposed. This 40MW line would terminate at Patutahi where a GXP would be established at the existing ENL zone substation site. Potentially the Gisborne GXP would be transferred to this location and the existing 110kv lines from Patutahi to the Gisborne GXP would be converted to 50kV. The Patutahi location facilitates the "easy" construction of new sub-transmission lines to the Matawhero industrial area where the majority of demand increase is expected to occur. The estimated cost of the new line is \$50mill and the new GXP \$15mill.

ENL has identified a line route from Tuai to Patutahi which can share an existing 11kV line route. The 11kV would be overbuilt with 110kV on concrete poles. A preliminary design of the line has been completed and a process relating to the obtaining of necessary easements is being developed.

The three 110kV line scenario will provide a transmission contingent capacity to the Gisborne region of 100MW.

Wairoa Point of Supply

There are no constraint issues at the Wairoa point of supply. The contingency rating of the 110kV lines from Tuai is 57MW. The normal/contingency rating of the 2x 10MVA 110/11kV transformers is 20/12 MVA. The maximum coincidental demand of the Wairoa network in 2005 was recorded as 11.66MW. After the application of load control, Waihi generation and Mahia generation the maximum demand at Wairoa GXP is 9.3MW.

Wairoa issues and development proposals relate to sub-transmission and distribution assets only.

Previously it was proposed that the ENL security for Wairoa GXP be reduced to from a C to a B1 classification. This would require only an

"n" level of security with 100% contingency capacity such that 75% of the load could be restored within 15 minutes, 90% within 3 hours and 100% restoration dependant upon repair time. Optimisation of the Wairoa GXP to this security level would have halved the quantity and value of assets required and save approximately \$40,000 pa in connection charges. It was proposed that the use of 1.5Mw of load control and 6MW of embedded generation, (5MW Waihi Hydro + 1MW Mahia Diesel) would compensate for the reduced service levels.

This proposal has now been discounted as it would result in an unacceptable divergence from ENL's security standards. Waihi Hydro only has 3 days storage capacity and cannot be relied upon to deliver 5MW on call. This was demonstrated in March/April 2002 when due to lack of rainfall Waihi was unavailable for evening peak reduction. Under the proposal should an event coincide with Waihi unavailability then a shortfall in contingent capacity would exist which could only be counted through the rationing of supply. The reduction of Wairoa GXP asset also would restrict the availability of capacity for growth.

Under changes in the 2004 ODV Handbook the Wairoa 110kV assets which had been optimised to 50kV were required to be reinstated to 110kV. This resulted in a 7.8%, (\$71,000) reduction in ENL connection charges.

Tuai Point of Supply

Transpower supplies ENL via a single 110/11kV 10MVA transformer at Tuai. The maximum demand at this connection is 650KVA. There is no growth forecast for this connection.

Transpower is keen to rationalize this connection as it will allow removal of assets and create room within their switchyard. It has been proposed in the past that ENL be supplied from the Genesis 11kV bus at Tuai.

Progress on implementing this proposal has stalled due to the requirement to resolve contractual issues between Genesis and Trust Power.

There is also potential to supply this connection via ENL's Tuai and Wairoa 11kV network segments as part of the long term development of Wairoa sub-transmission.

There is no schedule or cost pressure associated with rationalising the Tuai connection until Transpower signal that age based replacement of the 110kV transformer.

Aggregation

ENL has in the past presented a case for aggregation of demand at Gisborne and Wairoa to a single GXP at Tuai. If this were to happen, based of 2004 information the average of the 12 highest demands would reduce by 2.451MW. Based on ENL's 2006/07 transmission charges this would result in a \$157,000pa reduction in interconnection charges.

Transpower has dismissed this proposal on the basis that it is not permitted by its pricing methodology. Potentially, current reviews of Transpower's pricing may effect a change in this area.

Transmission Conclusions

Financial information relating to transmission development is provided in Section 6.12.

- Completed negotiations with Transpower on the proposal to upgrade transformer units and enter into a New Investment Contract. Scheduled completion of the upgrade to be in late 2006/07.
- Have Transpower continue investigations into relieving 110kV line thermal constraints; (establish 60MW contingency rating).
- Continue development of the option for a 3rd Tuai – Gisborne transmission line and GXP establishment at Patutathi.
- Reinitiate discussions with Genesis regarding connection of Tuai to their 11kV bus. In parallel develop the option of connecting ENL Tuai and Wairoa network segments.
- Pursue other valuation and optimisation issues, (e.g aggregation of GXPs).

4.7.1.2 Sub-transmission Development

Gisborne Sub-transmission

Within the urban Gisborne sub-transmission network previously identified demand growth triggers have been reached and associated investments have been made. In summary these are;

- A second 5/7MVA transformer was installed at Matawhero in 2003/04 as load exceeded 5MW.
- The 12.5MVA Port substation was installed in 2003/04 to relieve capacity constraint (9.5MW) at Kaiti and 11kV network constraint within the Gisborne CBD.
- To provide n-1 security to Parkinson, Makaraka and Matawhero substations and relieve 11kV network constraints the 50kV ring between Parkinson and Matawhero is required to be closed. The closing of the ring will be completed in 2006/07.
- A second 12.5MVA transformer was installed at Parkinson Street in 2004/05 as the contingency to support any one of three neighboring substations, (Carnarvon, Makaraka, Matawhero) exceeded 12.5MW.
- To relieve capacity constraint (12.5MW) at Carnarvon Street, the 50kV City ring between Carnarvon and Port is was closed. This allows load to be shifted to Kaiti and Port substations. The closing of the ring was completed in 2005/06.
- Replacement of under sized conductor on sections of the Gisborne – Makaraka 50kV interconnecting lines was completed in 2003/04. This increased the rating of the lines from 27MW (which had been reached) to the ENL standard for urban transmission of 36MW.
- The demand of JNL exceeded 5MW in 2004 and in 2005 they applied for an increase in the short term demand to 6.5MW with long term projections in the region of 8MW. This load could not be supported from the 11kV network and Matawhero substation so a 12.5 MVA substation has been constructed at JNL.

Completion of the above developments in 2006 will result in the full development of the urban Gisborne sub-transmission network. With the concentration of loads restricted to blocks of less than 12MW, n-1 security is provided without the requirement of dual transformers or large transformers in neighboring substations being needed to cover contingent events. Sufficient flexibility will therefore exist in key parts of the distribution system such as Matawhero, to accommodate forecast industrial load growth. Further development of the 11kV network is ongoing but is only undertaken in response to meet firm load growth requirements.

In the long term (20+ years) the ability to upgrade the urban sub-transmission system to address security or capacity constraints is

limited and will coincide with transmission constraint requiring a 3rd transmission line and new GXP.

Rural Gisborne Sub-transmission

Rural loadings are lower than the installed capacities of the sub transmission system. The daily load profile is reasonably flat, and there are few commercial and industrial loads.

As the loads are relatively low growth is extremely sensitive to even small subdivisions or commercial developments. The ability to accommodate growth too far out from the substations is also limited.

From an economic viewpoint, high levels of sub transmission investment made in this area cannot be justified, but long distances require high voltage and bulk supply has to be concentrated. Security provision would therefore normally require large, redundant assets. ENL has adopted a design approach where security is provided by standby generation support.

This approach has the potential to deliver better service, reduce zone substation asset investment, and avoid 11kV network reinforcement cost. Actions undertaken as a result of the installed generation in 2003 have included removal of high maintenance 2nd transformer banks and replacement of outdoor switchyards with indoor 11kV switchboards providing room for generators on existing sites.

Whangara Substation

ENL's has identified a project involving construction of a small Zone substation mid way between Tolaga Bay and Kaiti substations to eliminate the capacity constraints caused by the slow growth of Wainui beach. In the past Kaiti Substation's Dalton feeder had sufficient capacity to support Tolaga Bay without the need for the generator currently located at Tolaga Bay substation. The proposed wind farm project for Mokairau incorporates injection of load into the Kaiti-Tolaga 11kV network which would eliminate the constraint. If the generation project does not eventuate, construction of the Tatapouri substation is forecast to be required 2013 - 2015.

Close consideration of coordination between the Generation, Subtransmission and distribution development relating to the current constraint is required and minimal work is currently undertaken as needed while investigation work and monitoring is continued.

Ngatapa Substation

The Ngatapa substation has been identified as a key site in terms of location to provide security and support to the Matawai area currently supplied from Puha substation.

Currently Puha substation is linked to Patutahi via the 11kV network and supported by a 1MW generator to enable regular maintenance on the ageing transformers. The Matawai area is exposed in terms of ENL's security standard and by the single 11kV line from Puha to Otoko hill run over rugged inaccessible terrain. To overcome this issue installation of a Zone substation at Matawai combined with conversion of the 50kV line from Otoko to Matawai, currently operating at 11kV, back to 50kV has been considered.

The Ngatapa Substation has also been identified as requiring significant renewal work following assessments of the age and condition of a majority of the assets at the site.

To avoid the costs of both a new substation at Matawai and rebuild of Ngatapa substation, ENL plans to renew the Ngatapa substation and construct a section of 11kV line from the end of the Ngatapa feeder to Otoko Hill under the existing 50kV line route. The cost of the 11kV line while being close to the value of a new substation at Matawai will not only provide for the security requirements of Matawai but will provide the additional benefit of capacity support to the Puha substation.

Wairoa Sub-transmission

Wairoa sub-transmission issues relate to capacity constraint at Mahia and capacity availability for the forecast Wairoa CBD growth.

Mahia

Mahia is currently supplied at 11kV from a 33/11KV 1.5MVA transformer at Blacks Pad. This transformer is not fitted with on load tap changing capability. This coupled with the length of the 11KV line and current conductor size results in voltage stability issues occurring when demand exceeds approximately 800KVA. The Mahia Voltage Profile chart below shows the instances of when the 11kV voltage at Mahia is below limits.

Demand requirements at Mahia have increased due to the growth of dairy farming at Mahaunga and beach property subdivisions. The current rate of growth is forecast to continue due primarily to continuing subdivision activity. To date demand requirements exceeded the capacity of the Mahia transformer and are very seasonal in nature. This is illustrated by the Mahia Load Profile chart. It is

expected that over time this seasonality will not be as evident as more people take up permanent residence at Mahia.

Increasing demand requirements also result in increased voltage stability issues.

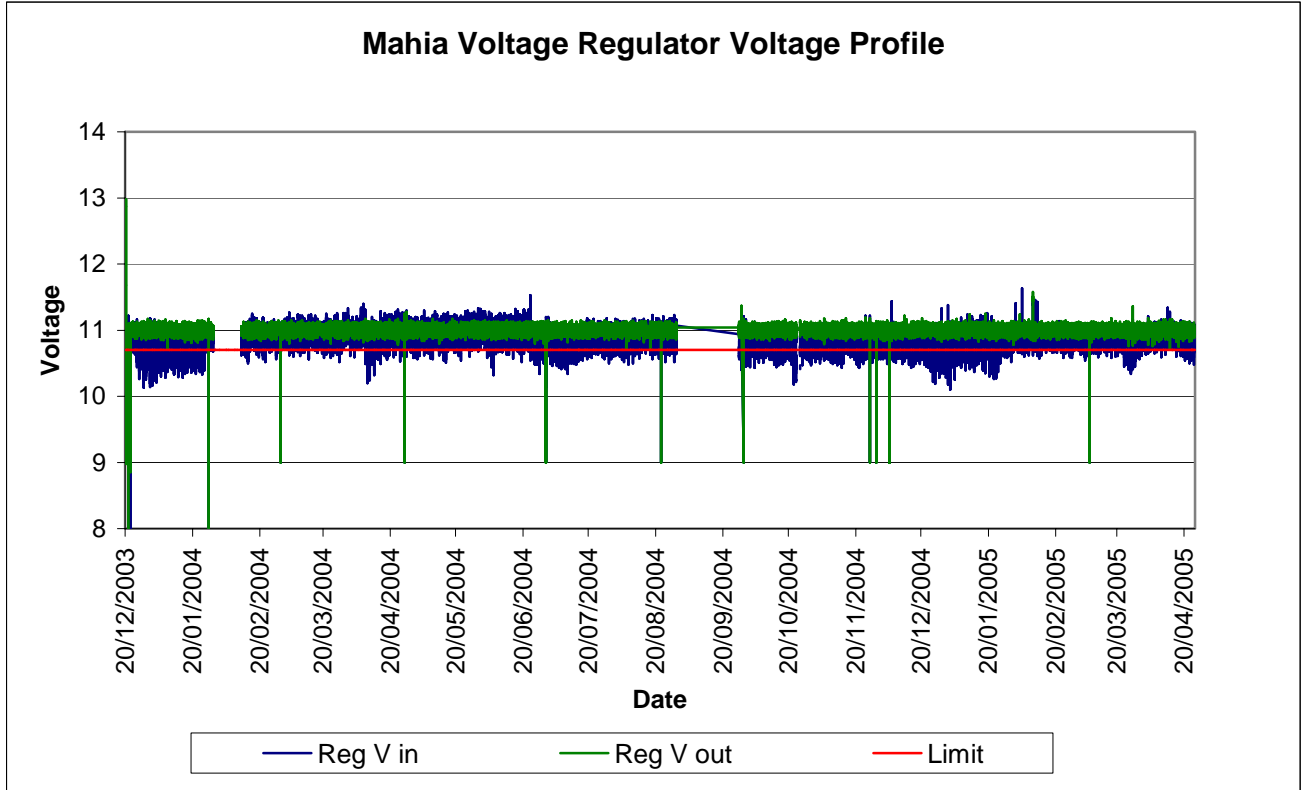

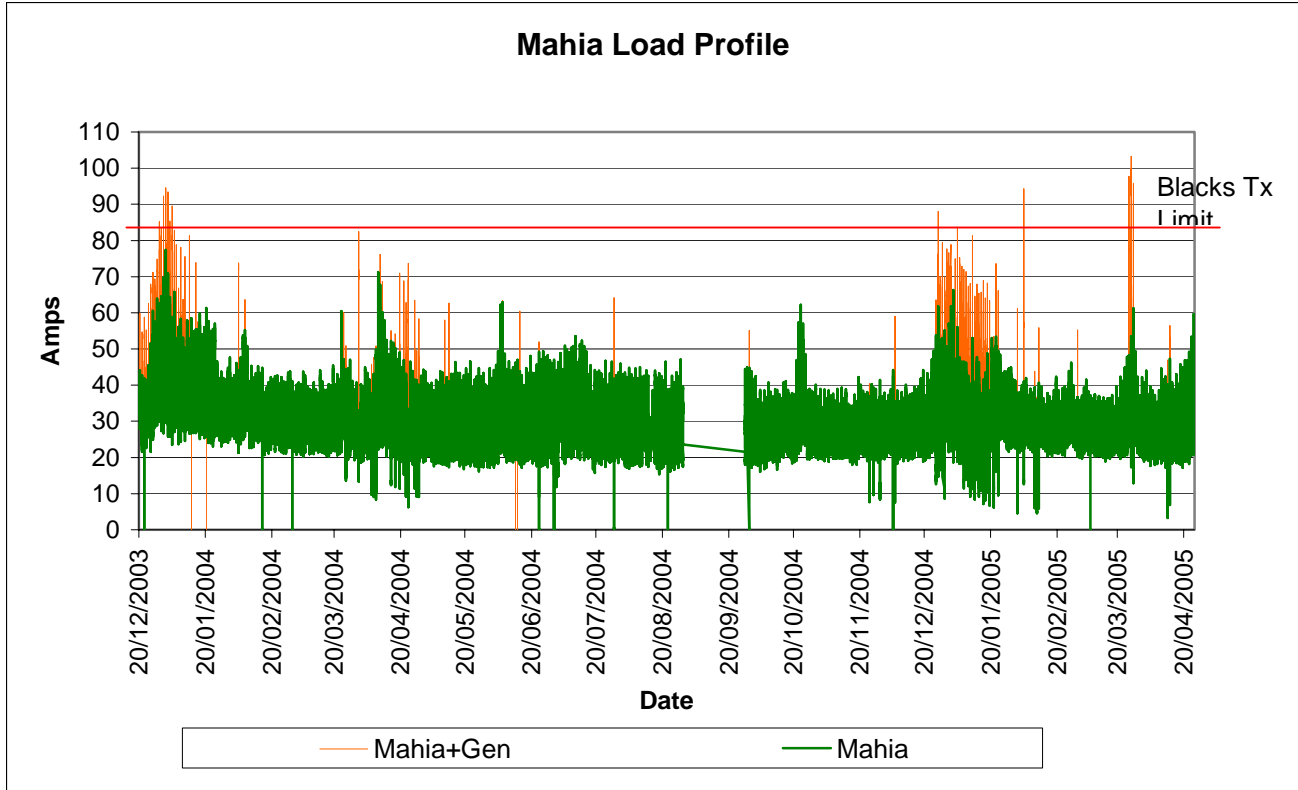

Since 2002 a generator has been installed and operated at Mahia during high demand holiday seasons to overcome capacity and voltage issues. However with the level of demand growth forecast to increase at Mahia and the expected change in demographics it is expected that the generator solution is limited to a maximum of 2 to 5 years.

Investigation has shown the upgrading of the 11kV Mahia network will not be sufficient to resolve current issues and accommodate increasing demand requirements. The optimum solution is to relocate the Mahia transformer closer to the load source and increase its capacity. This involves extending the 33kV line approximately 6.5km to Opoutama and establishing a small zone substation. The substation would comprise of a 2.5MVA transformer fitted with an on load tap changer.

It is proposed that the current 2.5MVA transformer located at Wairoa which supplies the Mahia 33kV line, would be relocated to the new zone substation and a new 12.5MVA transformer would be installed at Wairoa. This project is scheduled for 2006/07.

The cost of this option is estimated at \$1.5 mill. As this expenditure will result in little additional returns to ENL and additional financial contribution is being sourced from the developers in the form of

contributions linked to the capacity being developed and their specific requirements.

AFFCO & Wairoa CBD

AFFCO's current approximate maximum demand of 4MW is 35% of the total maximum demand (11.6MW) of the Wairoa network. Load increases at AFFCO have a significant influence on the Wairoa 11kV network as a whole. AFFCO is currently supplied at 11kV from Kiwi substation. The maximum capacity limit of this supply is 5MW, after this limit is exceeded the supply to AFFCO will be required to be at 33kV.

AFFCO have advised that in the medium term, (5 to 7 years) expansion of their plant may result in a maximum demand increase to 6.5MW. Also new load associated with sawmilling in Wairoa is forecast in the medium term will take the current contingent capacity of the 11kV network supplied from Kiwi substation.

Potentially opportunities exist to meet specific increased demand increases, (e.g. AFFCO) through embedded generation. EIL/ENL will investigate these opportunities.

The long term option for the sub-transmission development of Wairoa is that the current 110/11KV GXP supply be replaced with 110/33KV. An interim step is that in the medium term AFFCO is supplied at 33KV and the 50KV Waihi line is converted to 33KV and connected at Wairoa instead of Kiwi. This will restore contingent 11kV capacity to Kiwi and be available to supply other Wairoa growth including sawmilling.

The medium and long term options for sub-transmission development in Wairoa are shown on the following schematics. While the first stage of development is underway it should be noted that the final stage is still very much at the investigation stage.

**Medium term 33kV
Subtransmission
Development Wairoa**

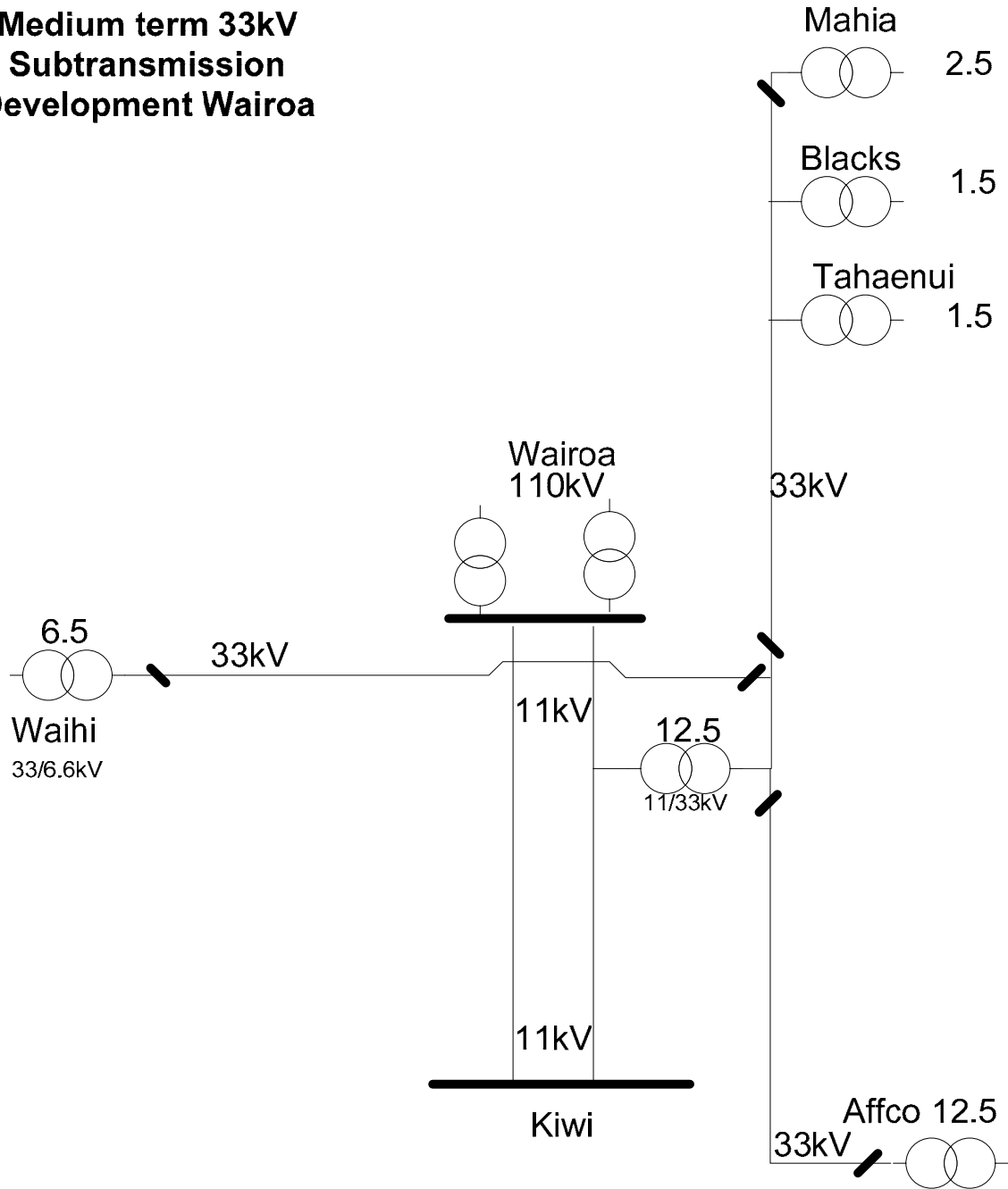

**Long term 33kV
Subtransmission
Development Wairoa**

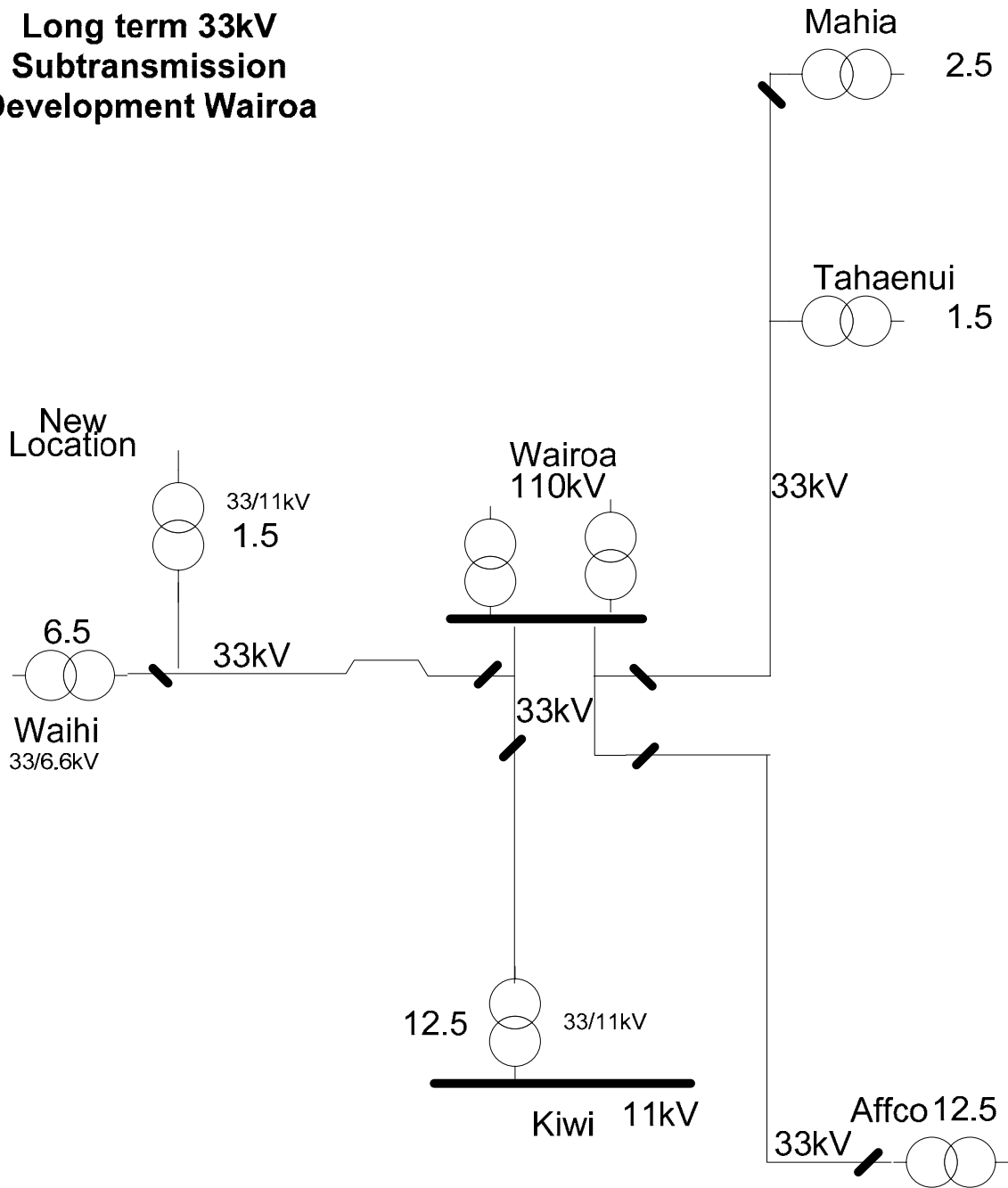

4.7.1.3 Generation Development

Investment in generation by EIL presents a business diversity option as well as being a least cost substitute for expensive transmission and/or sub-transmission investment.

The following daily load profiles show how the use of ENL's existing embedded generation when operated in conjunction with load control can effectively manage peak load periods creating a flat daily profile. These profiles indicate that there is little scope for additional peaking generation benefiting the overall demand side management of the assets. The contribution of base load generation opportunities is the preferred method to minimise further transmission and subtransmission investment.

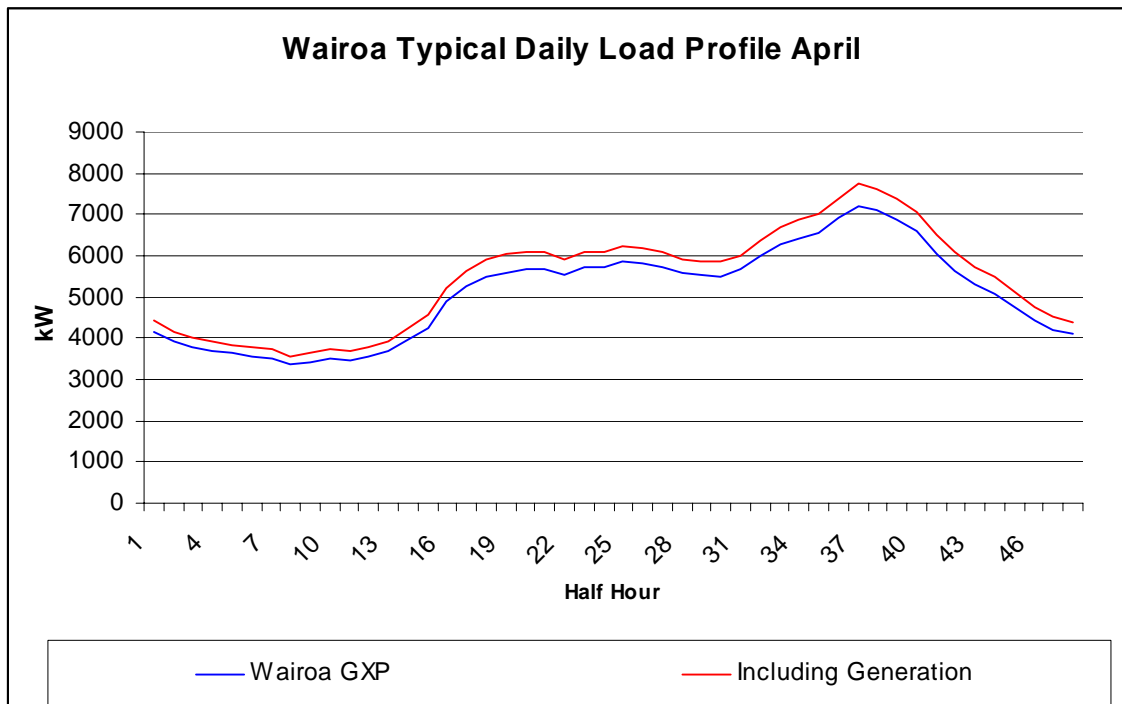

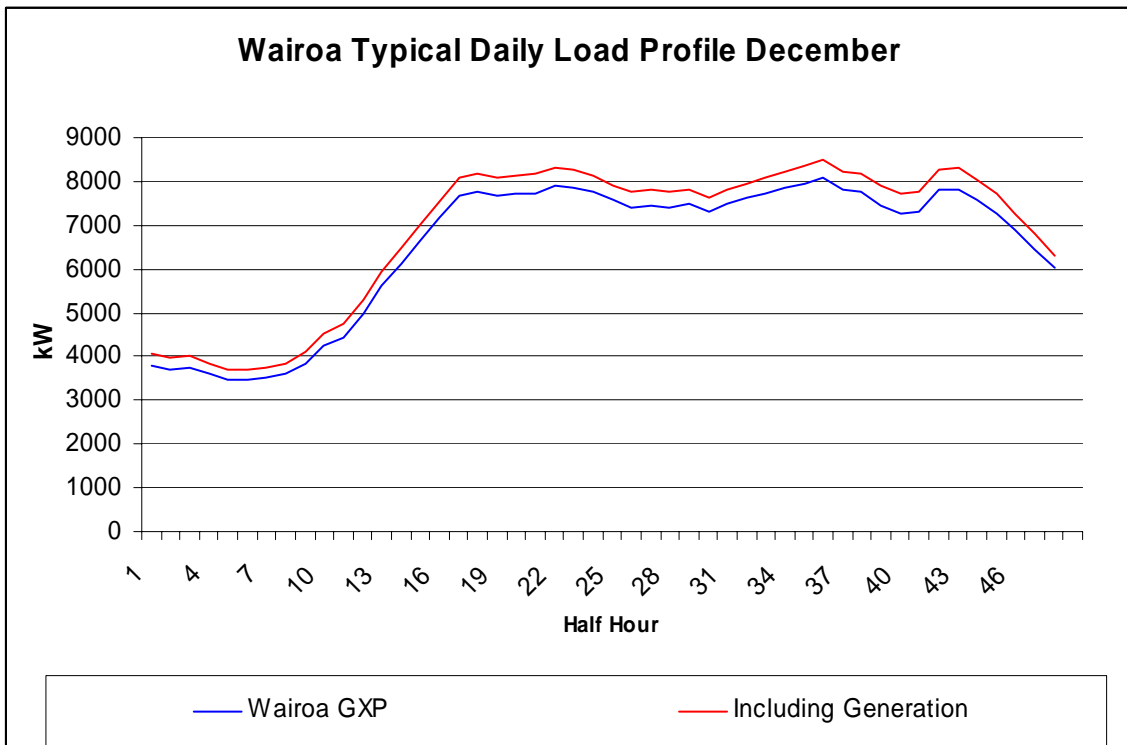
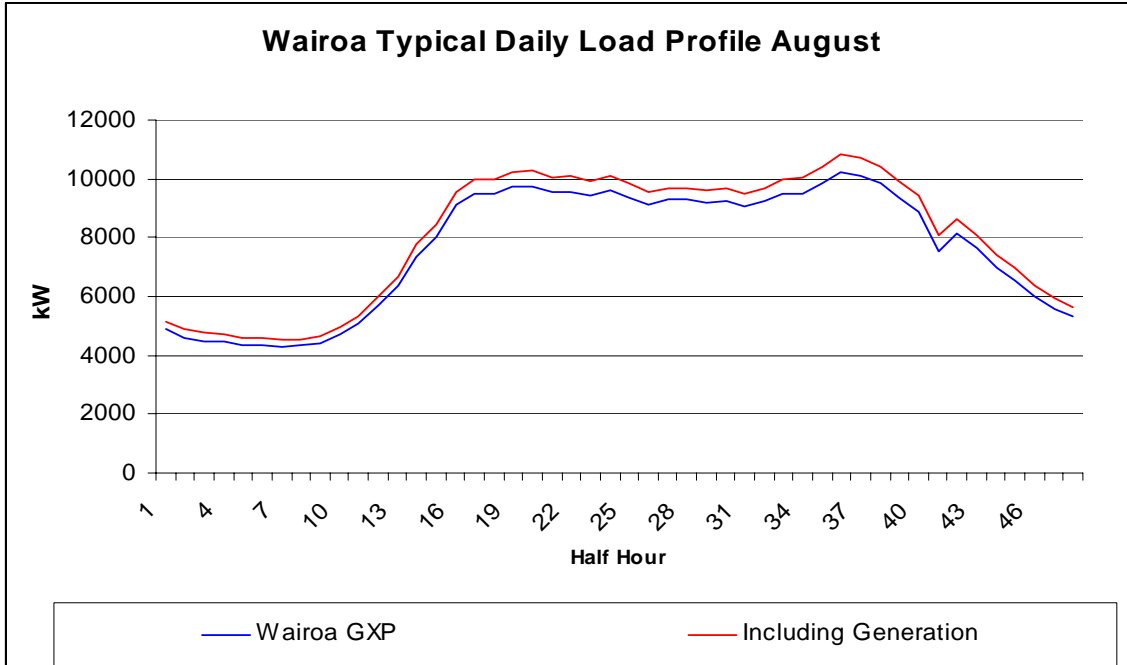

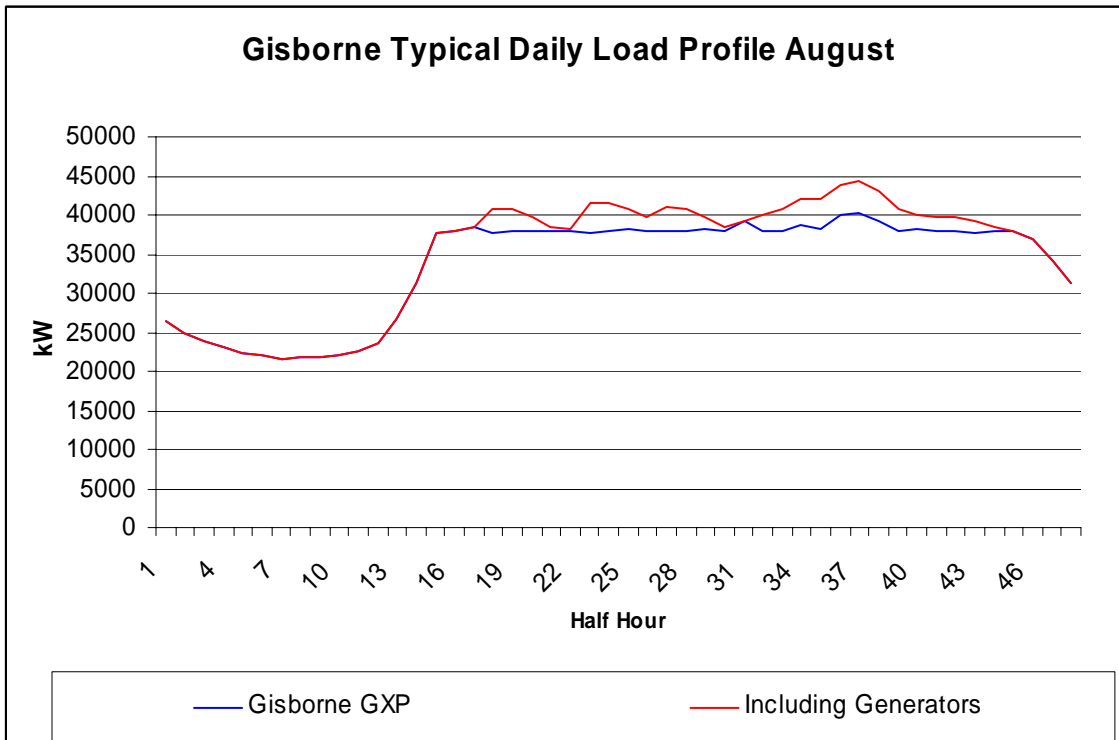
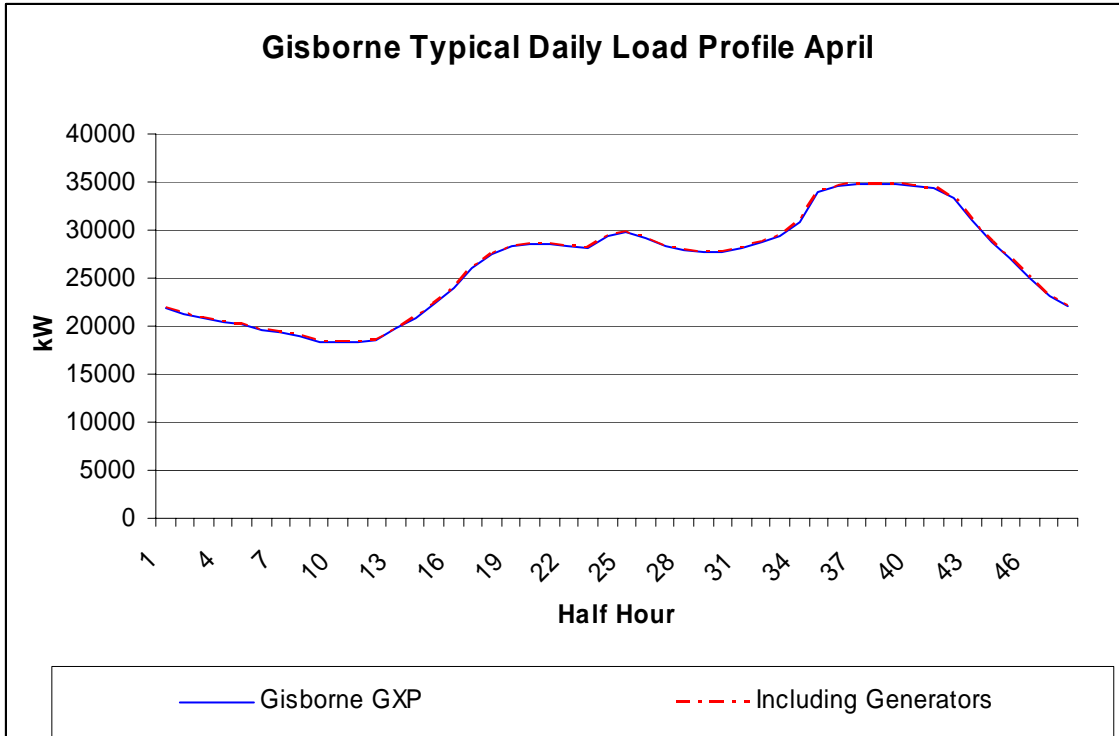

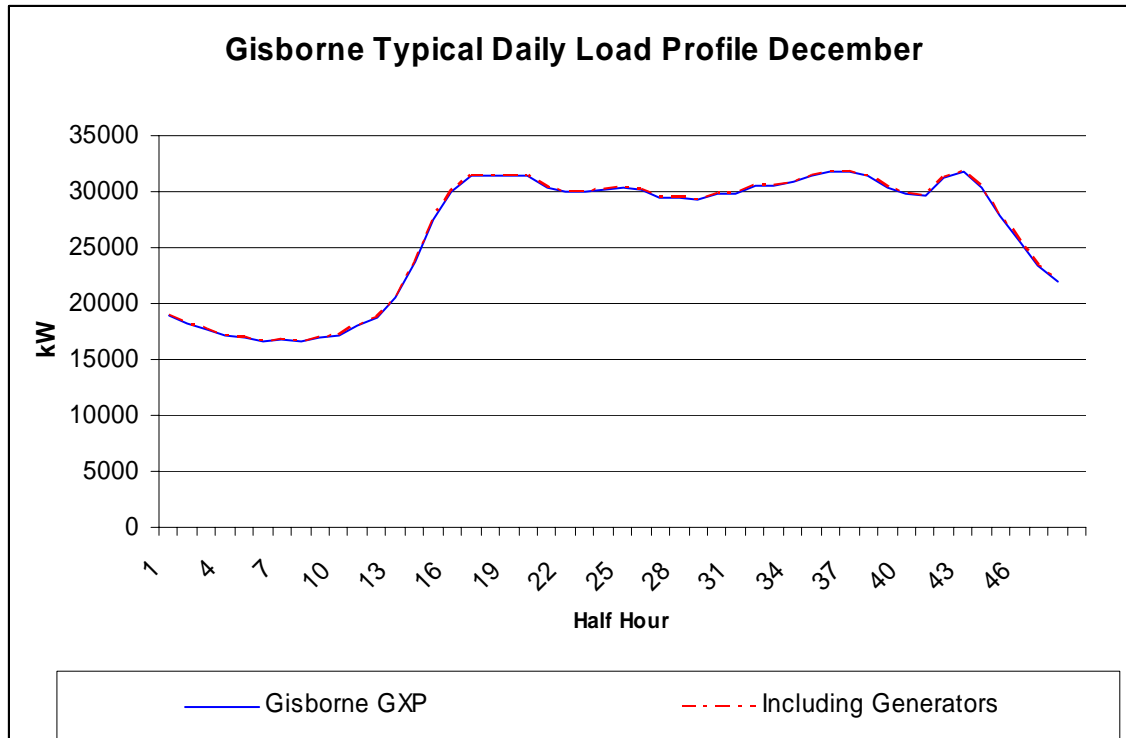

A review of alternative generation schemes previously investigated on the East Coast is being undertaken. The various schemes investigated included Hydro, Wind, Biomass and Co-generation (utilising natural gas). This review is being carried out in order to assess the viability of previously investigated generation options with regard to the increasing cost of energy and identify those worthy of further investigation

Wind

Wind monitoring is on going at a number of sites throughout the district. Several sites show potential; however lack of proximity to the existing distribution network is a general issue. Another issue is that should significant development of wind generation occur, further base load generation would have to be introduced. This is to ensure network stability and provide contingent capacity support.

Monitoring is currently being undertaken at Mokairau, Makarori and Whakapunaki. Of these sites only Mokairau has shown any real potential, but the site has significant constraints in terms of resource consenting issues. The 30m mast from Mokairau is due to be moved to Turihaua to commence monitoring there. This site has significant potential as it is higher then Makarori and in close proximity to the coast.

Potential also exists at Mahia with landowners interested in the establishment of monitoring on a site adjacent to the new 33kv line.

Biomass Generation

A proposal to install a biomass plant using waste from forestry and timber industries is being investigated. The plant would be sited at Matawhero and would supply developing large scale industry with both electricity and process steam. The potential outputs of this plant are yet to be determined and will be based around the requirements of the mill operators.

A study into residue volumes and delivered price at Matawhero has been completed. This report identifies an economic line within which residue could be delivered to a bio-mass generation facility. The report has indicated some level of forest residue collection is viable.

Hydro

In the 1970s and 80s a number of potential hydro schemes on the East Coast were investigated by Eastland Energy. With changes in the economic environment with respect to generation EIL is currently reviewing these investigations.

In addition to its own investigations, EIL is liaising with private investors who have identified other potential hydro schemes within the Gisborne and Wairoa regions.

Waihi Power Station improvements include the possibility of increasing the storage capacity of the dam by dredging sediment from the lake floor, and/or by raising the height of the existing dam wall. Initial investigations have proven both these proposals to be uneconomic at this time.

Gas Co-generation

Investigations into Gas Cogeneration have shown it to be uneconomic without an process heat off taker. There are also significant constraints on the regions gas supply, limiting any generation to around 6MWe. To make this type of generation cost effective it is imperative that an industry capable of utilising the process heat is found (e.g. timber drying). Further work is been undertaken in this area.

Customer installed Standby generation

Some opportunity exists for ENL to utilise customer installed standby generation as peaking plant. This opportunity is however limited as

few industrial customers in the region have at this time felt it necessary to make provision for or invest in security of supply. Two exceptions are Gisborne Hospital and the GDC Water Treatment Plant. A review of the suitability of these generators for use in a peaking role is currently being revisited.

Impediment to ENL Investment in Generation

For ENL investment in generation embedded within its existing networks would provide the benefits of;

- . Deferral of comparatively expensive transmission and distribution upgrades.
- . Improvement of the security of supply levels within the network.
- . Provide investors in forestry processing with forward energy price certainty, thereby providing stimulus for regional growth.
- . Assist to meet the nations ever increasing energy needs.

While ENL has identified and continues to research real opportunities for embedded generation, investment will be potentially stalled because of the following two key provisions of the Electricity Industry Reform Act 1998, (EIRA);

a) That lines businesses are prevented from trading in electricity hedge instruments. This impacts on the economics of lines companies investing in embedded generation in that it prevents the sale of output directly to customers and the associated capture, (and sharing with customers) energy retailer margins.

b) The Arms Length Rule which requires complete separation of lines and generation businesses with respect to governance, ownership and management. This requirement which makes investment decisions at the least difficult also prevents the capture of synergy gains of having one governance and management structure for both businesses.

ENL has raised its concerns with the appropriate regulatory agencies regarding how the EIRA inhibits its potential investment in embedded generation and continues to lobby for change.

4.7.1.4 Distribution Development

Conductor Upgrade

Section 4.4.3 of this document identifies when growth will or has caused 11kV capacity constraints either in terms of demand or more commonly in terms of voltage stability over distance. For feeders selected for duty as tie feeders providing contingency capacity to other feeders/substations there is a need to maintain spare capacity. In many cases there is limited or no contingent capacity remaining. In most cases the justification for the identified projects incorporates a renewal component that has not been included in the renewal projections. Refer section 5.4.

11kV Line upgrades specifically identified are as follows...

Year	Action	Cost
2006/07	Mahia – township 5km	150,000
2006/2007	Matawhero-Muriwai feeder 4km	135,000
2009/2010	Dalton Feeder Moana Rd Bypass 1.4km	98,000
2008/2009	Ngatapa to Otoko Hill 8km	250,000
2011/2013	Reinforce Cricklewood Spur 13km	390,000

From 2007/08 an allowance of 1.0km p.a. @ \$90,000/km is made for growth triggered routine 11kV line network extension.

11kV Cables that need to be upgraded for growth and security within the next 10 Years are indicated below.

Year	Location	Existing Size	New Size	Length	Cost
2006/07	Childers Disraeli Corner	95mm Al	185mm Al	50	\$60,500
2006/07	Roebuck Rd Palmerston Corner	70mm Cu	300mm Al	50	\$60,500
2006/07	Roebuck Rd Bridge	70mm Cu	185mm Al	350	\$70,000
					\$191,0000
2008/09	Carnarvon Sub to Childers Rd x 2	70mm Cu	185mm Al	280x2	\$112,000
2012/13	Plunket Sub to Ormond Rd (Peel St Bridge)	70mm Cu	300mm Al	320	\$67,200

						\$259,200
2010/11	City Feeder (Carnarvon-Pac'N'Sav)	70mm Cu	185mm Al	525		\$105,000
2011/12	Kahutia St Feeder (Carnarvon-Barry)	70mm Cu	185mm Al	1100		\$220,000
						\$325,000
2007/08	Reads Quay to Inland Revenue Sub	70mm Cu	300mm Al	290		\$60,900.00
2007/08	Inland Revenue Sub to Plunket Sub	95mm Al	300mm Al	330		\$69,300.00
						\$130,200.00
2013/14	Weigh Bridge to Hirini St	95mm Al	300mm Al	370		\$77,700.00
2014/15	Oak to Stout	70mm Cu	300mm Al	375		\$78,750.00
						\$156,450.00
2007/08	Port New Rd (External Funding)		300mm Al			-

An allowance of 1.0km p.a. @ \$200,000/km is made for growth triggered routine 11kv cable network extension.

Gladstone Rd Project

The existing high profile line on the main arterial route into Gisborne City has aged to a point where replacement is due age deterioration.

Significant redevelopment in the area, (CBD expansion, motel developments and in-fill housing) has changed the loading and required security requirements; hence installation of a single underground circuit replacing the double circuit overhead lines has been selected as the appropriate solution in this case.

Also as the circuit provides a link between Makaraka, Parkinson and Carnarvon zone substations, capacity is being increased from 4MW to 7MW. The project includes switchgear installation, 11kV/LV cable alterations and line work.

The project is summarised as follows...

YEAR	ACTION	ESTIMATE \$
2005/06	Charmers Rd to Lytton Rd, 0.8km (complete)	250,000
2006/07	Lytton to Stanley Rd, (0.95km)	400,000
2007/08	Stanley Rd to Roebuck Rd, (0.9km)	500,000

Development of Load Control System

Identified as an opportunity to optimise network performance and defer investment in demand side growth, options for development of the load control system have been considered.

ENL's load control system includes a significant amount of outdated pilot control. This is a hardwired cascaded relay system that has high maintenance costs. Because it can only support one control option and cannot be tailored to different loads, it fails to capture the entire controllable load on the network.

As a consequence of less effective control, there is less incentive for consumers to invest in energy storing appliances. The use of pilot control and lack of choice in controlled products is a primary influence for a peaky load profile, which is predominantly domestic load-driven.

There are no night-store heater tariffs available on the ENL network, appliances which are a major component of other networks controllable load base. Without products that are tailored to, for example, hot water cylinders of different sizes, there is no incentive to install storage capacity.

Removing the pilot system and substituting ripple control can give consumers a choice of any 3 control options from a selection of up to 20. This is a 10 year program which is currently into its 6th year.

The potential exists to capture an additional 4MW of controllable load. Timing is an issue in that 70% saturation of ripple control is needed before benefits are likely to be realised. Change cannot be accelerated to less than 4 years because ultimately it is limited by the household appliance life cycle.

Control in the non-domestic sector is at present virtually non-existent. Other networks offer controlled products specific to dairy sheds, irrigation and freezer loads. A further option that can be offered to businesses is supply with lower security levels, for example, a "first off – last on" priority load control product for non-essential load such as air-conditioning.

Since ENL is dependent on retailers passing through pricing to consumers, there is a major barrier to optimise load control. Concerns in the industry over this perceived lack of retail sector maturity are likely to be addressed at some point.

Wairoa has a particular problem due to the frequency selected for its ripple control system. High frequency signals have difficulty propagating through networks and therefore control is very unreliable for approximately 30% of the Wairoa load, (mostly rural/remote). The

potential for 2.5MW of controllable load, or the equivalent of one machine running at Waihi, exists at Wairoa. Load control development in Wairoa is further complicated in that the incumbent energy retailer owns the signal receiving equipment installed at customer's premises.

Summary of Actions

- Acquire spares 2006/07 \$100,000
- Install 2nd Injection point 2008 – 2011 \$200,000
- Continue phasing out of pilot control and substitution with a better range of ripple control products. (\$250,000 until 2010/11)
- Achieve better co-ordination of storage heater control and peaking plant operation.
- Investigate the installation of a new load control plant and hence changing the load control frequency at Wairoa. This require the replacement of signal receivers which are owned by energy retailers and installed in customers premises.
- Liaise with large energy retailers/customers on opportunities to implement demand side management. Develop pricing incentives to encourage this.

Power Factor Correction

Identified as an opportunity to optimise network performance and defer investment in capacity upgrades, options for improving levels of power factor correction have been considered.

Power Factor is poor in most rural areas of the network and correction would increase capacity at the 50 kV Gisborne bus by approximately 900 kW. This is the result of inadequate policing of standards for connection of motors.

The approaches to addressing this are...

- Installations can be inspected and customers notified of the need to add capacitors/correction. This would require contracting an inspector for a 12 month project but it avoids the cost of funding the correction. The most effective approach for dealing with non-compliance is one of penalty payment via pricing rather than attempting disconnection.
- Selected feeders can be corrected in bulk via the installation of static capacitors. This option is not suitable on tie feeders or areas

with significant controllable load, hence is restricted to rural feeders where loads are less than 400KW. And losses exceed 5%.

- Additional capacitance could be installed at the Transpower substation but this is the most expensive option and does not realise the benefit of reduced network losses.

Network Loss Reduction

Distribution network companies do not suffer a cost penalty for high losses. Hence there is little investment signal for reducing losses. This would imply that if voltage standards can be maintained then it is a valid commercial approach to minimize capital upgrades by not maintaining low loss levels.

It can also be argued that it is more economically efficient for the community to pay for losses than to fund capital expenditure particularly on rural feeders with poor economics. However in ENL's case where transmission is constrained the value of reducing losses can be measured against:

- 1) The cost of kWh of avoided transmission
- 2) The cost of new investment to increase capacity

Networks also have an obligation to manage their networks to good industry practice.

While voltage problems are not widespread on the network they do exist. An indicator of high losses is voltage sensitivity to load regulation. These issues are regularly evident in the following areas within ENL's network.

- Frasertown-Raupunga ring
Essentially distance is beyond the capability of 11kV reticulation and sub transmission support is required.
- Mahia
A large seasonal load at the end of the feeder suggests conductor reinforcement and sub transmission extension is required.
- Matawai
Load, distance and voltage contribute to marginal performance.

- Whangara
The long distance between Kaiti and Tolaga substations combined with high growth at Wainui is exceeding the conductor capacity and the Tatapouri voltage regulator limits.
- Ormond
Load, distance and voltage contribute to marginal performance

While losses are higher in certain other locations the number of supplies affected is small and load diversity may mitigate this to some degree. If the areas identified above were to see significant load growth, voltage performance would quickly become unsatisfactory.

When designing new or replacement networks the following loss standards are applied.

	Design %	Max. %
Sub transmission Lines	1	2
Zone Transformers	1	2
Distribution Lines	2	5
Distribution Transformers	2	4
LV Distribution	3	6
TOTAL	9%	19%
<u>Non-network losses</u>		
Service Line	3%	
Metering	2%	
Installation	3%	
TOTAL	8%	

Loss Analysis

ENL's total system losses are 8.2%. This is considered to be in the medium to high quartile. Compared to the standard it shows that there is considerable diversity in losses in components and in load (of which loss is a function).

Old zone transformers offer the greatest opportunity to reduce losses on ENL's network. There are 4 banks of 4 single-phase units on the network. These transformers have losses in the order of 6% as a result of the following factors:

- High loss iron (all pre-1964 development using steel alloy).
- 4 separate units contain more iron to magnetize.
- Sub-optimal load.

In all cases savings in losses (valued at transmission cost only) and reduced maintenance justifies replacement with modern 3-phase IMP units within a 5 year pay-back period. During 2001 dual transformer banks were eliminated at all rural sites except Patutahi.

Location	Capacity MW	Losses kW	Value p.a. \$
Tolaga T1	5	300	40,000
Puha T1	5	300	40,000
Patutahi T1	5	300	40,000
Patutahi T2	5	300	40,000

	Substation	Feeder	Load KVA	Losses KVA	% Losses
0101	Te Araroa	AWATERE	165	16	10%
0102	Te Araroa	HICKS BAY	228	24.7	11%
0103	Te Araroa	TE ARAROA	191	4	2%
0201	Ruatoria	RUATORIA	472	28	6%
0204	Ruatoria	MAKARIKA	212	24	11%
0206	Ruatoria	TIKI-TIKI	420	23	5%
0301	Tokomaru Bay	INLAND	136	10.2	8%
0302	Tokomaru Bay	SEASIDE	237	8.3	4%
0304	Tokomaru Bay	MATA RD	527	59	11%
0401	Tolaga Bay	TOKO-TIE	0	0	
0402	Tolaga Bay	TOWN	159	1	1%
0403	Tolaga Bay	ROTOTAHI	305	23	8%
0404	Tolaga Bay	TAUWHAREPARE	353	56	16%
0501	KAITI	HERSCHELL	576	9	2%
0502	KAITI	DALTON	1257	59	5%
0503	KAITI	TAMARAU	2117	51	2%
0504	KAITI	WAINUI	1241	22	2%
0505	KAITI	DE LATOUR	2857	52	2%
0506	KAITI	WHANGARA	-	-	-
0601	CARNARVON	KAHUTIA	2000	39	2%
0602	CARNARVON	CITY	2390	40	2%
0603	CARNARVON	WATTIES	1320	92	7%
0604	CARNARVON	ANZAC ST	900	33	4%
0605	CARNARVON	CHILDERS RD	2207	70	3%
0606	CARNARVON	AWAPUNI RD	870	30	3%
0607	CARNARVON	GLADSTONE RD	2320	37	2%
0608	CARNARVON	ABERDEEN RD	2570	48	2%
0701	PARKINSON	LYTTON RD	1567	36	2%
0702	PARKINSON	WILLOWS RD	1157	30	3%
0703	PARKINSON	ELGIN	1999	47	2%
0704	PARKINSON	JNL	4076	234	6%

	Substation	Feeder	Load KVA	Losses KVA	% Losses
0705	PARKINSON	INNES ST	225	5	2%
0802	MAKARAKA	CAMPION	-	-	-
0803	MAKARAKA	NELSON RD	-	-	-
0804	MAKARAKA	HAISMAN RD	-	-	-
0805	MAKARAKA	BUSHMERE RD	-	-	-
0902	PATUTAHI	LAVENHAM RD	475	18	4%
0903	PATUTAHI	WAIMATA	650	33	5%
0905	PATUTAHI	MURIWAI	536	26	5%
0906	PATUTAHI	TE ARAI	284	32	11%
1001	PEHERI	W O KURI	154	6	4%
1002	PEHERI	PARIKANAPA	50	9.8	20%
1003	PEHERI	TINIROTO	157	24.8	16%
1004	PEHERI	TAHUNGA	62	12	19%
11	NGATAPA	Total Substation	377	44	12%
1201	PUHA	WHATATUTU	365	34	9%
1202	PUHA	KANAKANAI	270	23	9%
1203	PUHA	TE KARAKA	195	10	5%
1204	PUHA	MATAWAI	629	81	13%
20	TUAI	Total Substation	1000	95	10%
2003	TUAI	RUAKITURI	460	69	15%
3101	WAIROA	RAUPUNGA	1057	126	12%
3102	WAIROA	FRASERTOWN	540	85	16%
3103	WAIROA	AWATERE	300	6	2%
3201	KIWI	BRICKWORKS	157	26	17%
3202	KIWI	AFFCO	3248	120	4%
3203	KIWI	NUHAKA	811	45	6%
3204	KIWI	BOROUGH ONE	1192	139	12%
3205	KIWI	BOROUGH TWO	1006	50	5%
3401	TAHAENUI	MORERE	300	31	10%
3301	BLACKS PAD	MAHIA	700	90	12%

Despite losses being high in terms of percentage, on some rural feeders the cost of re-conductoring is prohibitive unless needed for other reasons or attended to as part of a renewal program. Reactive support in the form of static capacitors is a viable option on rural feeders where:

- Losses exceed 5%
- Loads are less than 400kVA
- Losses exceed 27kW

Capacitors are expected to cost in the order of \$10,000 per site. They are not suitable on tie feeders or areas with significant controllable

load. In urban areas bulk correction at Transpower's connection is considered more effective.

In summary, approximately 7 feeders on the network are considered suitable for the application of reactive compensation by capacitors. However there is currently no commitment to this option as distributed generation strategies are being implemented which will provide for voltage support, reducing losses at high load times.

While ENL does not bear the cost of network losses it does bear cost of increased demand and transmission upgrade if losses are significant.

Reducing ENL losses is a relatively expensive although justifiable option for gaining 1MW of transmission capacity. Economics favor concentration on reduction of losses contributed by the older zone transformers on the system.

There are 4 x 5MW banks of single phase transformer units located at Puha, Patutahi and Tolaga. Two of these banks are at Patutahi and will be reduced to one when the Matawhero – Parkinson 50KV ring is complete and age replacement is due. Both Puha and Tolaga only require 2.5MW transformers.

These old transformers have high loss iron, are not loaded at peak efficiency, and twice the iron in their magnetic circuits compared to a 3 phase unit. Consequently they are costing about \$30,000 p.a. each in excessive iron losses. This saving alone would pay back their \$700,000 total replacement in less than 10 years.

Uneconomic Rural Lines

Twenty percent of ENL distribution lines are considered uneconomic. Calculation of value objectives has indicated the need to reduce value in remote and rural areas. ENL has developed a strategy for the management of uneconomic lines as it expects the obligation to maintain supply to be extended beyond the current horizon date of 2013.

Assets classed as rural will be allowed to depreciate to an average remaining life of 13 years by 2009. The assets will then be maintained at this level. Assets classed as remote will also be permitted to depreciate to an average remaining life of 13 years by 2011. Following this the lines will be maintained at this level via a combination of renewal at lower cost, service line handover and cost contribution strategies. Alternative energy supply solutions are also

expected to be part of the economic outcome. These tactics in the medium term partly address the issues regarding levels of renewal investment discussed in Section 5.4.

Renewal of the remote assets at a lower cost design solution can be achieved via reduction to single-phase in place of 3-phase construction.

Investigation of a number of construction options and voltages has been considered. The most economic solution for the terrain on ENL's network appeared to be 22kV single wire earth return. However other factors including new easement negotiation, telecom interference issues, and re-insulation costs, have now been considered and suggest conversion to single phase 11kV is the most practicable in terms of a viable and sustainable solution.

Because the ODV already assumes optimization of the existing 3 phase construction to single phase construction, the actual cost of maintaining the existing construction standard is far greater than the return permitted on an optimized asset. This is compounded by the fact that the assets in question have exceeded their economic life and cost approximately three times as much to maintain as asset in optimum condition. New assets have near nil operating costs for approximately 20 years. These factors make such replacements an economic proposition.

300km of network in the Gisborne region in uneconomic zones has provisionally been identified as suitable for conversion.

It should be noted that:

- A number of low consumption supplies would be disconnected (at the customer's option)
- Service line costs will remain the customers' responsibility.
- Some customers will face additional costs of replacing 3 phase motors with single-phase motors.

Preliminary communications indicate that customer contribution options to fund the rebuild work are unacceptable. In addition there is no mechanism under the Targeted Control Regime to recover costs via specific price schedules. ENL is continuing to discuss and negotiate with regulatory authorities on an appropriate mechanism to address the viability of having uneconomic lines.

Further detailed work is required before this expenditure can be approved and the program developed for inclusion in work plans beyond 2011.

4.7.1.5 Development Co-ordination

Capacity and security constraints impact different components of the transmission and distribution system and vary with growth expectations. Growth cannot be excluded at transmission level because it has the ability to outstrip the best laid development plans.

In the future a high degree of co-ordination will be required to implement approved transmission, sub-transmission and generation options so that investment is complimentary and supports the strategic objectives. Also it is preferable that development options are where possible implemented incrementally so that adjustments can be made in response to changing circumstances.

4.7.2 Development program

Expenditure forecasts based on the options considered for major initiatives are given below

Year	Action	Cost
2006/07	Gisborne GXP TX Upgrade	\$4,500,000
2006 -2008	Gladstone Road	\$900,000
2006/2007	Mahia 2.5MW ex-Wairoa, 33kV Line & Upgrade Wairoa to 12 MW	\$1,500,000
2006-2008	Upgrade 2.5MW T1 Ngatapa	\$700,000
2009/10	Tuai – Gisborne 110kV Line – Thermal Upgrade	unknown
2013 - 2015	Whangara Zone Substation 2.5MW	\$850,000
2017/18	Wahi/AFFCO/Wairoa 33kV Supply & Rationalisation	\$3.0mill
2020	Tuai – Gisborne 110kV Line Re-conductor & 3 rd 60MVA TX	\$10 - \$20mill
2020	Tuai – Gisborne 3 rd 110kV Line & new GXP Patutahi	\$65mill
2014/2015	T1 2.5MW and new sub at Tatapouri	\$850,000
2016/2017	T1 12.5MW and new sub at Mangapapa	\$1,200,000
2009	Biomass generation Provision	\$70mill
As needed	Connection of Customer installed Generation Provision	\$50,000
2010-2011	Mokairau Generation Provision	\$20mill
2015-2017	Transformer Patutahi Provision	\$500,000

5. Managing the assets lifecycle

All physical assets have a lifecycle, and ENL's electricity assets are no exception. This section describes how ENL manages its assets over the entire lifecycle from "conception" to "burial".

5.1 What is the lifecycle of an asset

The lifecycle of an existing asset is outlined in Figure 5.1(a) below...

Figure 5.1(a) – Asset lifecycle

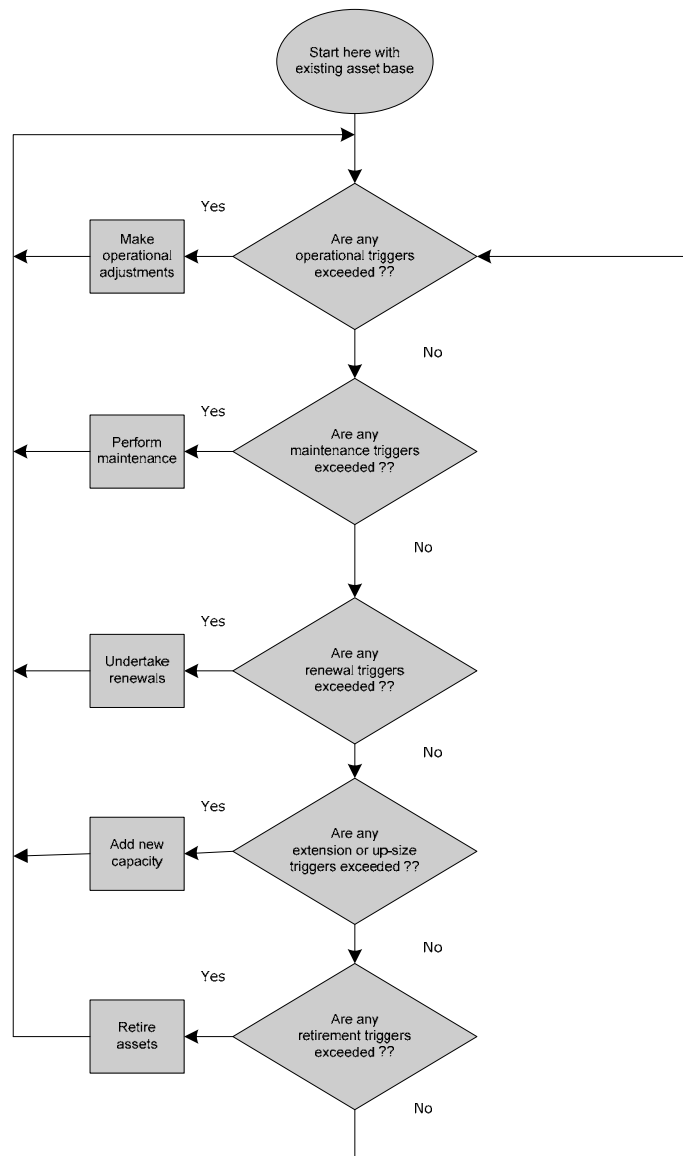

Table 5.1(b) below provides some definitions for key lifecycle activities...

Table 5.1(b) – Definition of key lifecycle activities

Activity	Detailed definition
Operations	Involves altering the operating parameters of an asset such as closing a switch or altering a voltage setting. Doesn't involve any physical change to the asset, simply a change to the assets configuration that it was designed for. In the case of electrical assets it will often involve doing nothing and just letting the electricity flow.
Maintenance	Involves replacing consumable components like the seals in a pump, the oil in a transformer or the contacts in a CB. Generally these components will be designed to wear out many times over the assets design lifecycle and continued operation of the asset will require such replacement. There may be a significant asymmetry associated with consumables such as lubricants in that replacing a lubricant may not significantly extend the life of an asset but not replacing a lubricant could significantly shorten the assets life.
Renewal	<p>Generally involves replacing a non-consumable item like a pole or transformer with a replacement item of identical functionality (e.g. strength, capacity). Such replacement is regarded as a significant mile-stone in the life of the asset and may significantly extend the life of the complete asset (e.g. the section of line and poles).</p> <p>Renewal also includes the replacement of components or items that no longer comply with initial design criteria, regulatory requirements or safety standards.(e.g. a rotten poles cannot support conductor design load, new regulatory standards for earthing, new safety requirements for switchgear operation)</p> <p>Renewal tends to dominate the CapEX in low growth areas (Quadrant 1 of Figure 4.1.2(b)) because assets will generally wear out before they become too small.</p> <p>The most typical criteria for renewal will be when the capitalised costs of ops and maintenance exceed the cost of renewal (including any loss of availability). Key issues with renewal are technological advances that generally make it impossible to replace assets such as SCADA with equivalent functionality, and creeping regulation that make certain assets (e.g. compressed air vessels over 100psi) unviable.</p>
Up-sizing	Generally involves replacing a non-consumable item like a conductor, busbar or transformer with a similar item of greater capacity but which does not increase the network footprint ie. restricted to Quadrants 1 and 2 in Figure 4.1.2(b).
Extensions	Involves building a new asset where none previously existed because a location trigger in Table 4.1.3(a) has been exceeded eg. building several spans of line to connect a new factory to an existing line. This activity falls within Quadrants 3 and 4 of Figure 4.1.2(b). Notwithstanding any surplus capacity in upstream assets, extensions will ultimately require up-sizing of upstream assets.

Retirement	Generally involves removing an asset from service and disposing of it. Typical guidelines for retirement will be when an asset is no longer required. Retirement can be considered “replacement with nothing”.
------------	--

5.2 Operating the assets

As outlined in Table 5.1(b) operations predominantly involves doing nothing and simply letting the electricity flow from the GXPs to consumers’ premises year after year with occasional intervention when a trigger point is exceeded (however the workload arising from tens of thousands of trigger points is substantial enough to merit a dedicated control room). As outlined in Figure 5.1(a) the first efforts to relieve excursions beyond trigger points are operational activities and may include...

- Operating a tap-changer to correct voltage excursions (which generally occurs automatically).
- Opening and closing ABS’s or RMU’s to relieve an over-loaded asset.
- Opening and closing ABS’s or RMU’s to shutdown or restore power (which can be either planned or fault related).
- Operating load control plant to reduce demand.
- Activating fans or pumps on transformers to increase the cooling rate.

Table 5.2(a) outlines the key operational triggers for each class of ENL’s assets. Note that whilst temperature triggers will usually follow demand triggers, they may not always eg. an overhead conductor joint might get hot because it is loose or rusty rather than overloaded.

Table 5.2(a) – Operational triggers

Asset category	Voltage trigger	Demand trigger	Temperature trigger
LV lines & cables	<ul style="list-style-type: none"> • Voltage routinely drops too low to maintain at least 0.94pu at consumers switchboards. • Voltage routinely rises too high to maintain no more than 1.06pu at consumers switchboards. 	<ul style="list-style-type: none"> • Consumers' pole or pillar fuse blows repeatedly. 	<ul style="list-style-type: none"> • Signs of burning or melting.
Distribution substations	<ul style="list-style-type: none"> • Voltage routinely drops too low to maintain at least 0.94pu at consumers switchboards. • Voltage routinely rises too high to maintain no more than 1.06pu at consumers switchboards. 	<ul style="list-style-type: none"> • Load routinely exceeds rating where MDIs are fitted. • LV fuse blows repeatedly. • Short term loading exceeds guidelines in IEC 354. 	<ul style="list-style-type: none"> • Inspection reveals signs of heating
Distribution lines & cables	<ul style="list-style-type: none"> • Load flow analysis identifies sections in the danger zone, followed by verification from recorders 	<ul style="list-style-type: none"> • Load flow analysis identifies sections in the danger zone, followed by verification from loggers. • SCADA set point alarms routinely triggered 	<ul style="list-style-type: none"> • Joint fails or shows signs of heating
Zone substations	<ul style="list-style-type: none"> • Voltage drops below level at which SCADA set point alarms triggered. <p>OLTC can automatically raise taps.</p>	<ul style="list-style-type: none"> • Load exceeds guidelines in IEC 354. 	<ul style="list-style-type: none"> • Top oil temperature exceeds manufacturers' recommendations. • Core hot-spot temperature exceeds manufacturers' recommendations. • Infra-red survey reveals hot joint • Gas analysis indicates burning in Transformers
Sub-transmission lines & cables	<ul style="list-style-type: none"> • Load flow analysis identifies sections in the danger zone, followed by verification from loggers. • SCADA set point alarms triggered 	<ul style="list-style-type: none"> • Load flow analysis identifies sections in the danger zone, followed by verification from loggers. • Transpower alarms triggered • Analysis of GXP data shows excessive levels 	<ul style="list-style-type: none"> • Infra-red survey reveals hot joint • Joint fails in service

5.3 Maintaining the assets

As described in Table 5.1(b) maintenance is primarily about replacing consumable components. Examples of the way in which consumable components “wear out” include the oxidation or acidification of insulating oil, pitting or erosion of electrical contacts, and wearing of pump seals. Continued operation of such components will eventually lead to failure as indicated in Figure 5.3(a) below. Failure of such components is usually based on physical characteristics, and exactly what leads to failure may be a complex interaction of parameters such as quality of manufacture, quality of installation, age, operating hours, number of operations, loading cycle, ambient temperature, previous maintenance history and presence of contaminants – note that the horizontal axis in Figure 5.3(a) is not simply labeled “time”.

Figure 5.3(a) – Component failure

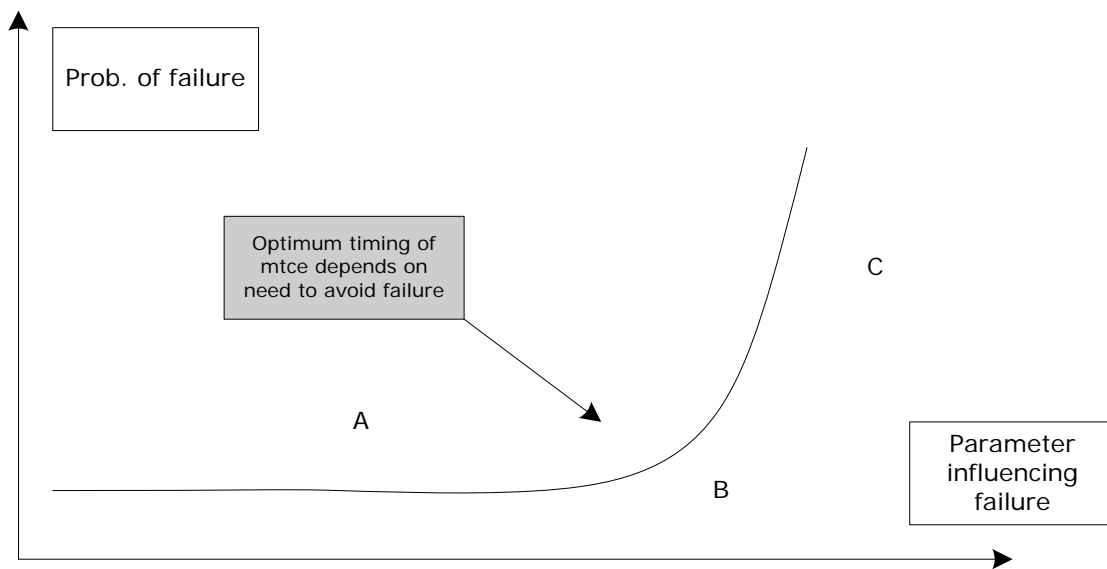

Exactly when maintenance is performed will be determined by the need to avoid failure. For instance the need to avoid failure of a 15kVA transformer supplying a single consumer is low, hence it might be operated out to point C in figure 5.3(a) whilst a 50/11kV substation transformer may only be operated to point B due to a higher need to avoid failure. In the extreme case of, say, turbine blades in an aircraft engine it would be desirable to avoid even the slightest probability of failure hence the blades may only be operated to point A. The obvious trade-off with avoiding failure is the increased cost of labour and

consumables over the assets lifecycle along with the cost of discarding unused component life.

Like all ENL's other business decisions, maintenance decisions are made on cost-benefit criteria with the principal benefit being avoiding supply interruption. The practical effect of this is that assets supplying large consumers or numbers of consumers will be extensively condition monitored to avoid supply interruption whilst assets supplying only a few consumers such as a 15kVA transformer will more than likely be run to breakdown. The maintenance strategy map in Figure 5.3(b) broadly identifies the maintenance strategy adopted for various ratios of costs and benefits.

Figure 5.3(b) – Maintenance strategy map

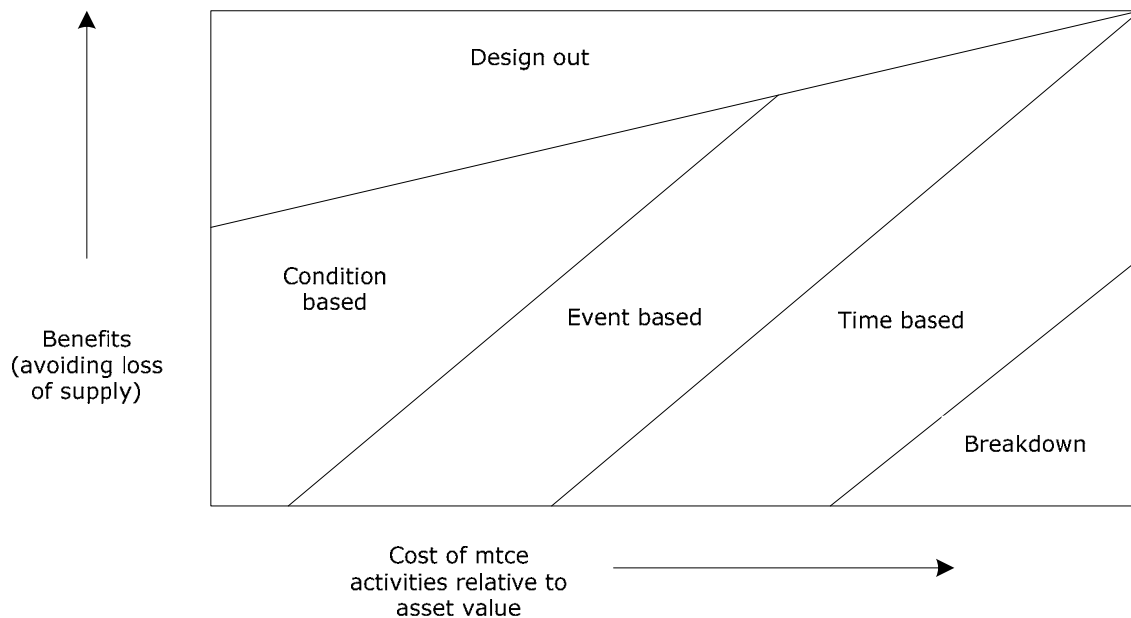

This map indicates that where the benefits are low (principally there is little need to avoid loss of supply) and the costs of maintenance are relatively high an asset should be run to breakdown. As the value of an asset and the need to avoid loss of supply both increase ENL relies less and less on easily observable proxies for actual condition (such as calendar age, running hours or number of trips) and more and more on actual component condition (through such means as DGA for transformer oil).

Component condition is the key trigger for maintenance, however the precise conditions that trigger maintenance are very broad, ranging

from oil acidity to dry rot. Table 5.3(c) describes the maintenance triggers ENL has adopted...

Table 5.3(c) – Maintenance triggers

Asset category	Components	Maintenance trigger
LV lines & cables	Poles, arms, stays & bolts	<ul style="list-style-type: none"> Evidence of dry-rot or spalling. Loose bolts, moving stays. Displaced arms.
	Pins, insulators & binders	<ul style="list-style-type: none"> Obviously loose pins. Visibly chipped or broken insulators. Visibly loose binder.
	Conductor	<ul style="list-style-type: none"> Visibly splaying or broken conductor. Poor clearances Visibly Uneven sag Trees in lines
	Cable	<ul style="list-style-type: none"> Failure of insulation
Distribution substations	Poles, arms & bolts	<ul style="list-style-type: none"> Evidence of dry-rot or spalling. Loose bolts, moving stays. Displaced arms.
	Enclosures	<ul style="list-style-type: none"> Visible rust. Cracked or broken masonry. Overgrown access Safety issues
	Transformer	<ul style="list-style-type: none"> Excessive oil acidity (500kVA or greater). Visible signs of oil leaks. Excessive moisture in breather. Visibly chipped or broken bushings.. Visible rust
	Switches & fuses	<ul style="list-style-type: none"> Build up of contaminants Operations at recommended maintenance levels Failure of fuse elements
Distribution lines & cables	Poles, arms, stays & bolts	<ul style="list-style-type: none"> Evidence of dry-rot. Loose bolts, moving stays. Displaced arms.
	Pins, insulators & binders	<ul style="list-style-type: none"> Obviously loose pins. Visibly chipped or broken insulators. Visibly loose binder. Radio interference
	Conductor	<ul style="list-style-type: none"> Visibly splaying or broken conductor. Poor clearances Signs of clashing Visibly Uneven sag Trees in lines
	Ground-mounted switches	<ul style="list-style-type: none"> Detectable discharge

		<ul style="list-style-type: none"> • Detectable hot spots • Buildup of contaminants • Oil/Gas leaks • Visible Rust
	Regulators	<ul style="list-style-type: none"> • Excessive oil acidity (500kVA or greater). • Visible signs of oil leaks. • Excessive moisture in breather. • Visibly chipped or broken bushings.. • Visible rust • Binding mechanisms
	Cables	<ul style="list-style-type: none"> • Failure of insulation • Oil leaks
Zone substations	Fences & enclosures	<ul style="list-style-type: none"> • Visible damage • Visible rust • Leaks • Safety issues
	Buildings	<ul style="list-style-type: none"> • Visible damage • Leaks • Visible deterioration • Backed up pipes • Leaking taps • Visible Rot • Broken fittings
	Bus work & conductors	<ul style="list-style-type: none"> • Visibly splaying or broken conductor. • Poor clearances • Signs of clashing • Visibly Uneven sag • Trees in lines •
	33kV switchgear	<ul style="list-style-type: none"> • Detectable discharge • Detectable hot spots • Failure to operate • Operations at recommended maintenance levels
	Transformer	<ul style="list-style-type: none"> • Excessive oil acidity • Visible signs of oil leaks. • Excessive moisture • Visibly chipped or broken bushings.. • Visible rust • Excessive noise • Excessive gas content
	11kV switchgear	<ul style="list-style-type: none"> • Detectable discharge • Detectable hot spots • Failure to operate • Operations at recommended maintenance levels
	Instrumentation	<ul style="list-style-type: none"> • Unreadable • Inaccurate readings • Miss operation
	Poles, arms, stays & bolts	<ul style="list-style-type: none"> • Evidence of dry-rot or spalling. • Loose bolts, moving stays. • Displaced arms.
Sub-transmission lines & cables	Pins, insulators & binders	<ul style="list-style-type: none"> • Obviously loose pins. • Visibly chipped or broken insulators. • Visibly loose binder.

		<ul style="list-style-type: none"> • Radio interference
	Conductor	<ul style="list-style-type: none"> • Visibly splaying or broken conductor. • Poor clearances • Signs of clashing • Visibly Uneven sag • Trees in lines
	Radios and repeaters	<ul style="list-style-type: none"> • Communications fade or unavailability over limits • Levels out of allowable limits • Frequencies out of range
Communications	RTU's	<ul style="list-style-type: none"> • False indication occurs • Fails to indicate • Controls fail to function • Measurements suspected as being out of valid range • Equipment Lockup
SCADA		<ul style="list-style-type: none"> •

5.3.1 ENL's maintenance policies

The maintenance section of the lifecycle management plan describes details of the regular on-going work that is necessary to keep assets operating to their design levels, including the basis for condition monitoring, equipment standards, planned maintenance and provisions for unplanned actions in response to faults or incidents. Condition monitoring activities have been developed for each type of asset. These are presented by individual asset category using the same nomenclature as the CapEx plans. Maintenance work is entirely driven from condition and reliability monitoring, as opposed to planned maintenance based on time usage of an asset.

5.3.1 Fault Management

All fault response work is contracted to two external service providers. The provision of call centre services is currently contracted to a company based in Hawke Bay. The scope of this contract, which has a term of 3 years and expires in 2009, includes the receiving of fault calls from customers and energy retailers and the dispatch of fault response resources.

A second 3 year contract for the provision of resources for fault restoration and minor repairs is currently held by a national company which in order to service the contract has resources located in Wairoa, Mahia, Gisborne and Tokomaru Bay. As specified in the contract any renewal required following the initial fault response is determined as maintenance or capital in accordance with ENL accounting policies.

The annual Fault Management fee associated with these contracts is allocated, (in proportion to the number of faults forecast), across asset classes as follows;

50kV	\$ 15,240
11kV	\$118,500
400V	\$ 14,850
Load Control	\$ 2,970
Zone Subs	\$ 4,610
Transformers	\$ 3,700
Switches	\$ 2,340
Pole Equip	\$ 3,00

5.3.2 Subtransmission lines

A visual ground patrol of every urban 50 and 33 kV pole and the conductors is carried out every twelve (12) months. A helicopter patrol of every rural 50 and 33 kV line is carried out every twelve (12) months. The following points will be included in the inspection:

- Structure foundation erosion (weather or excavator work)
- Structure movement and conductor clearance
- General hardware, insulator and conductor condition
- Early signs of cross-arm burning
- Damaged or broken binders
- Monitor vibration dampener performance
- External interference (e.g. trees)
- Sabotage

A climbing inspection is carried out on 50 & 33 kV poles every five (5) years.

Discharge detection and ultrasound scans of selected areas of line are undertaken annually. Repairs required as a result of the scans are categorised in terms of risk and scheduled for correction within 1 year.

Pole Assessment Criteria

Every pole has a safety index record which will be updated as a result of ultrasound scan tests. Poles with a safety index less than 1.5 are red tagged and are replaced within 3 months, whilst poles with a safety index between 1.5 and 2.5 are identified with a blue tag and require testing before climbing.

Poles with a safety index between 1.5 and 1.75 are replaced within 12 months in high population density or risk areas and within 2 years in other areas. Poles with a safety index between 1.75 and 2.00 have repeat ultrasound scans every 2 years until replaced. Poles with a safety index between 2.00 and 2.50 have repeat ultrasound scans every 5 years until replaced. Poles with a safety index between 2.50 and 3.00 have repeat ultrasound scans every 10 years until replaced. Poles with a safety index greater than 3.00 have repeat inspections every 20 years.

Note concrete poles only require a visual inspection per the above as below ground rot does not occur. Visual inspection identifies at risk poles.

Poles identified as being at risk will have a below ground / ultrasound scan within 6 months. The results of the test will indicate the need for red or blue tagging of the poles.

Standards

Various standards used include the following:

- AS/NZS 4056 and 4676 for concrete poles,
- AS 2209 for wooden poles.
- Specific standards for conductors, line hardware and fittings.

Planned Actions	Total	Quantity	Unit Cost
Patrols (Ground & Helicopter)	\$24,000	2000	\$12
Inspections (Climbing)	\$20,500	136	\$150
Testing – Ultrasound scan (Poles)	\$10,000	200	\$ 50
Testing (Cables)	\$ 0	0	0
Discharge/Ultrasound	\$ 14,400	30km	\$480

Unplanned Actions

Tree control (refer 11kV Lines and Cables)	N/A
Defect / Fault repairs	\$16,200
Fault response (incl. Helicopter)	\$22,500
Radio Interference correction	\$8,000

5.3.3 11kV lines and cables

A visual patrol of every pole and the conductors is carried out every ten (10) years. Should any defects be discovered then a full below ground testing will be done within a year.

A tree control program consisting of hazard identification and notification in accordance with the Electricity (Hazards from Trees) Regulations 2003 has been developed. Elements of this program include...

- Patrolling of the network to identify and record tree interference/hazards. These patrols are undertaken on 12-18 month cycles.
- The identification of tree owners whose trees are a hazard and the issuing of Hazard Warning Notices or Cut/Trim Notices and subsequent negotiations.
- The engagement of accredited contractors to undertake ENL funded first cuts and/or the removal of "no interest" trees.

Every year the first two (2) kilometres of overhead feeders out of substations are thermo vision and discharge scanned to identify any hot and/or noisy spots.

At risk poles are identified for patrols and testing from the pole database records. Replacement and monitoring strategies are as per the pole assessment in 50kV lines section.

Key 11kV cables have partial discharge monitoring on a five (5) yearly basis. Key cables are established as typically having a length greater than 100 metres and normal load in excess of 40% of the cable rating. Cables requiring replacement are scheduled in the CapEx program.

Due to the unavailability in the market of insurance cover for significant events affecting distribution network assets, ENL has in place;

- Storm/significant event contingency funding of at \$100,000 per year
- A \$1.0mill borrowing provision reserved in its annual funding plan.

Standards

Various standards used include the following:

- AS/NZS 4056 and 4676 for concrete poles.
- AS 2209 for wooden poles.
- Various specific standards for conductors, line hardware, fittings and cable types.

Planned Actions	Total	Quantity	Unit Cost
Patrols	\$30,000	250km	\$120
Testing –ultrasound scan (poles)	\$40,000	800	\$50
Testing –partial discharge (cables)	\$10,000	20	\$500
Tree control program	\$174,000	-	-
Storm contingency	\$100,000		
Thermo vision/ultrasound	NA (refer Zone substation Maint)		

Unplanned Actions	Total	Quantity	Unit Cost
Trees forced cutting	\$40,000	100	\$400
Defect / Fault repairs	\$210,000		
Fault response	\$120,000	120	\$1000
Control and dispatch costs	\$20,000		

5.3.4 LV lines and cables

A visual patrol of every pole and the conductors is carried out every ten (10) years. Should any defects be discovered then a full below ground inspection will be done within a year.

Tree patrols, notification and cutting are undertaken in conjunction with the 11kV Tree Control program.

At risk poles are identified for patrols and testing from the pole database records. Replacement and monitoring strategies are as per the Pole Assessment in 50kV Lines section.

No planned cable maintenance activities are deployed. Replacement is programmed in capital works budget from analysis of performance from fault statistics.

Standards

Various standards used include the following:

- AS/NZS 4056 and 4676 for concrete poles.
- AS 2209 for wooden poles.
- Various specific standards for conductors, line hardware and fittings.
- Various standards for cable types used.

Planned Actions	Total	Quantity	Unit Cost
Patrols	\$10,000	50km	\$200
Testing –Ultrasound scan (Poles)	\$15,000	300	\$50
Testing (Cables)	\$0		
Tree control Program	Refer 11kV		

Unplanned Actions	Total	Quantity	Unit Cost
Trees forced cutting	Refer 11kV		
Defect / Fault repairs	\$ 50000		
Fault response	\$ 25,000	100	\$250

5.3.5 Service connections

Electrical inspectors (not EIL employees) visually patrol and inspect LV service connections every twenty years. Where the inspection identifies problems liaison is directly with service connection owner. The repairs of the defects are the responsibility of the service connection owner within six (6) months. In cases of high safety risk, and no action by the service connection owner the service connection may be disconnected.

Inspection of private HV service connections every 5 years is the responsibility of the private owner. However problems identified during 10 yearly visual patrols covered in the 11kV lines section are notified to the private owner for correction within 6 months.

Compliance with Voltage levels is monitored via voltage checks.

Planned Actions	Total	Quantity	Unit Cost
-----------------	-------	----------	-----------

Patrols/inspection	\$ 5,000	500	\$10
Unplanned Actions	Total	Quantity	Unit Cost
Voltage Checks/Complaints	\$20,000	100	\$200

5.3.6 Load Control

The Load control injection plant and coupling cells are tested and inspected each year prior to the main winter load period. Controllable load will be tested each year prior to the main winter load period. Any defects found are repaired immediately

Standards

Injection equipment is maintained within the Manufacturers specifications for the operating frequency and voltage levels.

Planned Actions	Total	Quantity	Unit Cost
Injection plant testing	\$8,000	2	\$4000
Unplanned Actions	Total	Quantity	Unit Cost
Defect repairs / replacement costs (Excludes capital relay costs)	\$5,000		
Fault response (Pilot circuits)	\$9000	36	\$250

5.3.7 Zone Substations

Each Zone Substation will be inspected every three (3) months which will include inspection and cleaning activities associated with...

- Transformers
- Circuit breakers
- Switchgear including connections or terminations
- Protection and control equipment
- Scada and communications systems
- Structures, insulators and bus work
- Overhead line connections
- Voltage regulators
- Zone substation LV switchboards
- DC switchboards and battery systems

- Earthing systems
- Emergency and contingency systems
- Buildings
- Fences
- Oil containment
- Pest control measures
- Drainage

Safety equipment inspection and testing at each zone substation is undertaken 6 monthly whilst an independent Occupational Health and Safety inspection of each zone substation is made annually.

Thermo vision and ultrasound inspection of all zone substations is carried out annually. The earthing system resistance at each zone substation is tested every two (2) years. All urgent defects are repaired on discovery, major non urgent defects are repaired within three (3) months, and other minor defects will be included in the normal maintenance program.

Time based maintenance schedules are maintained for equipment at each zone substation. These schedules are modified following evaluation of inspection and condition assessment results. The typical frequencies range from 2 to 5 years. The lower 2 yearly frequencies are largely due to older equipment. Required equipment maintenance based on inspection and condition monitoring is then carried out. The summary below shows the average annual costs for routine adjustment, testing, calibration and preventative maintenance of the zone substation and rural voltage regulator equipment.

Routine Maintenance Summary

Voltage Regulators	\$3,000
TeAraroa Sub	\$6,000
Ruatoria	\$7,000
Tokomaru bay	\$4,000
Tolaga Bay	\$6,000
Kaiti	\$5,000
Carnarvon Street	\$4,000
Port	\$2,000
Valley Rd	\$ 500
Parkinson Street	\$4,000
Matawhero	\$4,000
Makaraka	\$4,000
Patutahi	\$5,000

Puha	\$3,000
Ngatapa	\$6,000
Pehiri	\$6,000
Hexton	\$1250
Goodwin Rd	\$1250
Wairoa Substation	\$2,000
Kiwi Substation	\$4,000
Blacks Pad	\$1,000
Tahaenui	<u>\$1,000</u>
TOTAL	\$80,000

Standards

Environmental standards for noise control and oil contamination levels are maintained within council specifications. Zone substations are maintained within the requirements of Health and Safety, Electricity, Environmental and Building acts, regulations and codes of practice.

Planned Actions	Unit	Total
3 Monthly Inspections (25 sites 4 Visits p.a.)	\$250	\$25,000
Ground Maintenance (20 sites 12 visits p.a.)	\$125	\$30,000
Safety inspections & tests (20 sites 2 visits p.a.)	\$250	\$10,000
OHS inspection (20 sites)	\$250	\$5,000
Thermo or ultrasound inspections (20 sites)	\$250	\$5,000
Average Routine Maintenance		\$80,000

Unplanned Actions	Total
Defect / Fault repairs	\$25,000
Fault response	\$4,100

Note - work associated with circuit breakers, switching equipment, control/SCADA and protection equipment and LV / DC Systems at zone substations has been included.

5.3.8 Zone Substation Transformers

Activities include...

- Bi-annual DGA analysis
- Bi-annual Furans analysis
- Thermo vision as part of substation maintenance

- Painting as required
- Tap changer oil flushing
- Tap changer overhaul per manufacturer's recommendations
- Process oil as required
- Major overhaul as required

Note - major overhauls are not undertaken on single phase banks. Replacement with a new 3 phase transformer is more economic.

Standards

Based on BS 148, IEC 42 and Transpower standards.

- Oil acidity < 0.1 mgkOH/g
- Oil electrical strength > 40kV
- Moisture content < 30 ppm
- Resistivity 20 deg >=60 G ohms per metre
- Dissolved gas limits
 - Hydrogen 50 ppm
 - Methane 50 ppm
 - Carbon Monoxide 300 ppm
 - Carbon Dioxide 3000 ppm
 - Ethylene 100 ppm
 - Ethane 100 ppm
 - Acetylene 15 ppm

While standards concentrate on maintaining oil condition it is important not to confuse this with transformer condition. These standards must be maintained in order for the transformer to achieve standard life. Exceeding the standards results in permanent damage and shortening of transformer life. DGA analysis provides indication of developing faults and the need for internal maintenance. Trends are monitored to assess expected life/aging.

Specific earthquake restraint designs are provided for the transformer installations.

Planned Actions

Transformer painting, 2 per 2 years	\$15,000
DGA furrow tests, 10 p.a.	\$10,000

Average tap changer overhauls 1 unit p.a.	\$15,000
Average oil processing - 2 p.a.	\$12,000

5.3.9 Circuit breakers

Substation circuit breakers are inspected visually during 3 monthly substation inspections. The annual thermo vision survey includes all substation circuit breakers. Trip testing is carried out in conjunction with protection testing. Partial discharge testing is carried out on indoor circuit breakers. The frequency of the testing cycle increases as discharge levels increase over time. This work is covered in the zone substations section. This is the main indicator of CB insulation condition and therefore CB life.

Di/dt circuit breaker wear monitoring is implemented where protection equipment has this capability. The information is recorded and assessed as part of the Zone substation inspection work.

The number of trip operations is monitored via SCADA or as part of the 3 monthly / annual inspections. Remote or field circuit breakers are inspected annually and trip testing is carried out at intervals not exceeding 3 years. Minor and major maintenance assessments are used to determine end of life and replacement triggers. Work under taken during these activities generally includes:

- Oil replacement
- Adjustment of travel and mechanisms
- Mechanism lubrication
- Contact replacement if required
- Cleaning, painting
- Trip testing, timing
- Re-insulation, replacement of damaged or worn components.

Variation of discharge or thermo vision results from previous results triggers major maintenance of the circuit breakers

Standards

- AS/NZS 2650 Common specifications for HV switchgear.
- Manufactures specifications for each type of equipment.

Transformer loading on ground mount substations is monitored annually via MDI readings. Low voltage panels of all Ground style substations over 100kVA are inspected annually MDI readings are recorded.

All ground mount units located in areas accessible to the public receive a Certificate of compliance check every 5 years.

No maintenance activities are carried out on smaller in-service transformers.

Transformers returned from the field for service, receive minor refurbishment work is carried out where the age of the units is less than 20 years old.

Earth testing is carried out on a 5 year cycle. Earths include distribution substations, switch sites and LV earths. Earthing system repairs are undertaken on the worst 20% of earth tests above 50 ohms. Earth tests between 0 and 50 ohms are considered adequate in terms of the expected seasonal variation in ground moisture content.

Standards

Refurbishment is only considered if the transformer condition is such that it has 15 years remaining service life and cost is less than 25% of a new transformer. Economics is limited by the frequency of relatively expensive recovery and installation.

Planned Actions	Quantity	Unit Cost	Total
Refurbishment <100kVA	5	\$1500	\$7500
Refurbishment >100kVA	2	\$4000	\$8000
Painting ground mount/graffiti	20	\$150	\$3000
Annual ground mount insp. & MDIs	200	\$50	\$10000
Oil Handling /filtering /TX disposal			\$10000
Transformer 5 yearly Compliance checks	100	\$50	\$5000
Earth testing	1000	\$45	\$45000
Earthing system repairs	60	\$500	\$30000
Oil Analysis	20	\$300	\$6000

Unplanned Actions	Total
Defect /Fault repairs	\$15,000
Vegetation clearance	\$ 1,000

5.3.11 Pole Mounted Isolation Equipment

Inspection of all 50KV air break switches is carried out in conjunction with climbing patrols 2 yearly. Visual inspection of the switch contacts and mechanism and Inspection and testing of the earthing (refer earth testing in the Transformer section) is carried out.

ABS's not operated regularly enough to maintain correct their functionality, clearly do not necessary and targets for removal. Testing operation of the switch is carried out where this is possible without a shut-down. Live line methods are deployed to carry out maintenance on switches where necessary. Defects are documented as found and corrective action prioritised as necessary to prevent failure in service. This may involve nil operation until the opportunity to coordinate with other work.

Standards

- Equipment maintained in accordance with Manufacturers specifications.

Planned Actions	Total	Quantity	Unit Cost
Inspection and Testing	\$12,000	40	\$300

Unplanned Actions

Defect /Fault repairs	\$10,000
-----------------------	----------

Note - work associated with pole mounted isolation equipment at zone substations is included in the zone substations section

5.3.12 11kV Switchgear (ground mounted)

Ring main units, oil filled isolators, fuse units and Magnefix are inspected yearly. A service / inspection requiring a shutdown is carried out at intervals not exceeding 5 years.

At larger industrial substations switchgear is surveyed bi-annually using thermo-vision equipment. The survey generally provides early warning of poor or failing connections to the switchgear and poor

contacts. The frequency of monitoring will be increased if testing identifies problems developing at a higher rate.

Partial Discharge monitoring is also carried out on larger switchboards at intervals not exceeding 5 years where proximity to transformers does not cause interference. The frequency of monitoring will be increased if testing identifies problems developing at a higher rate.

Standards

- Oil leaks and low oil levels are repaired within 6 months.
- Rust is treated within 12 months.

Maintenance activities

For RTE switches maintenance is carried out in conjunction with refurbishment of the transformers when they are removed from service.

Routine maintenance work requiring shut downs is opportunistic. This is a major constraint on the level of confidence that can be applied to equipment reliability.

Servicing is carried out on the basis of the inspection results. Activities include:

- Exterior painting on site
- Oil replacement
- Contact replacement
- Termination inspections and cleaning where possible
- Termination replacement

Quadrant type air break switches are targeted for removal as identified in Section 8.A.10. A cost of \$58,000 p.a. reducing to \$30,000 p.a. in 2010/11 is allowed for the removal of these assets.

Planned Actions	Total	Quantity	Unit Cost
Annual Inspection	\$10,000	167	\$60
Average Switch maintenance p.a.	\$38,000	38	\$1,000
Termination Inspection	\$5,960	40	\$149
Quadrant ABS Removal	\$58,000	29 p.a.	\$2000

Unplanned Actions	Total	Quantity	Unit Cost
--------------------------	--------------	-----------------	------------------

Defect /Fault repairs \$10,000

5.3.13 LV switchgear

A visual patrol of LV Disconnection and Link boxes is carried out every 5 years and larger link boxes are checked and cleaned during 3 yearly inspections. LV panels in ground mount substations are inspected in conjunction with annual transformer Inspections. No routine maintenance activities are undertaken on overhead LV equipment.

Standards

Legal compliance and pre-emption of faults.

Planned Actions	Total	Quantity	Unit Cost
Inspections/servicing	\$15,000	50	\$300
Unplanned Actions			
Defect /Fault repairs	\$ 8,000		
Painting / Graffiti	\$ 4,000		

5.3.14 Control and protection

Operation of the equipment is monitored via the SCADA system all operation events are investigated to ensure the operation of devices occurred correctly. Incorrect operation of protection has been found to occur with some equipment types typically in relation to auto-reclose controls. Relay testing and CB trip testing frequencies for relays vary depending on the type and age of devices. The functionality of the tapchangers is monitored via the SCADA system.

Battery 110V. To ensure close monitoring of battery condition and loading to maximize life of the new batteries proposed, battery monitors will be installed. The monitors will reduce future battery maintenance costs.

Battery handling procedures and facilities are incorporated into health and safety inspections annually.

Standards

- Within manufactures specs for individual relays and equipment.
- Where liquid batteries are contained within buildings separate rooms are used with good ventilation. Where this cannot be achieved batteries are housed in outdoor containers.

Maintenance activities

- Tap change control – Adjustment and calibration of AVR's not exceeding 4 yearly
- Transducers – calibration not exceeding 4 yearly
- 24V battery systems – First test 2 years after initial installation, thereafter annual Load test on 24V battery systems
- 110V battery systems – Annual physical inspection and load test (monitoring on line)
- Protection Electromechanical – Annual secondary tests
- Protection Solid-state – 3 yearly secondary tests
- Protection Microprocessor – 4 yearly tests
- CB trip testing – Not exceeding 4 yearly (refer Circuit Breaker maintenance)
- Transformer protection not exceeding 4 yearly
- Fire safety and intruder systems not exceeding 6 monthly

Note - work associated with protection and control equipment is included in the related asset section.

5.3.15 Communications

A degree of remote monitoring of the radio systems is in place to provide early warning of equipment malfunction. Six monthly testing and calibration is carried out to ensure the equipment performance is within specification.

Standards

- Complies with the Radio Spectrum Management Conditions and Radio Communication Regulations.
- Operates within manufacturers specifications.
- Power - repeaters – 25W, RTs – 5W.
- Drift - no more than 2 kHz.

- Frequency.
- Heat levels within manufacturers specifications.
- One complete spare link and 2 portable repeaters are maintained for contingency operations.

Planned Actions	Total
Maintenance/Calibration	\$35,000
Track Maintenance	\$10,000
Hut Maintenance	\$4,000
Radio Licences	\$13,000

Unplanned Actions

Defect/Fault repairs	\$20,000
----------------------	----------

5.3.16 SCADA

In general the RTU input and output functions are tested in conjunction with maintenance of the associated equipment. During protection and switchgear testing the digital indications, analogs, measurement and control functions are verified back to the master station. General indications such as door security and fire alarms are verified during 3 monthly inspections.

Other indications such as DC battery and mains fail alarms are verified during RTU inspections at intervals not exceeding 2 years. This work is generally coordinated with other activities being undertaken at the substations.

Standards

- Operates within manufacturers specifications

Planned Actions	Total
Support fees	\$10,000
Software Licences	\$5,000
SCADA maintenance allowance	\$10,000
Configuration file alterations	\$6,000

Unplanned Actions

Defect/Fault repairs \$10,000

5.4 Renewing assets

ENL classifies work as renewal if there is no change (usually an increase) in functionality, i.e. the output of any asset doesn't change. The key criteria for renewing an asset is when the capitalised operational and/or maintenance costs exceed the renewal cost. This can occur in a number of ways...

- Operating costs become excessive e.g. Addition of inputs to a SCADA system requires an increasing level of manning.
- Maintenance costs begin to accelerate away e.g. a transformer needs more frequent oil changes as the seals and gaskets perish.
- Supply interruptions due to component failure become excessive (and what constitutes "excessive" will be a matter of judgment which will include the number and nature of customers affected).
- Renewal costs decline, particularly where costs of new technologies for assets like SCADA decrease by several fold.
- The asset does not comply with Design, Regulatory or safety requirements.

Because of the low growth and surplus capacity in the network, the capital expenditure is dominated by renewals. The rate of renewal can be used to manipulate the age of each asset category relative to its rate of depreciation. Most of ENL's asset categories are being renewed at a rate less than the depreciation but commensurate with constrained revenue, hence the overall asset is aging.

While the renewal rate manipulates the age of the population for each asset category, the historical population age profile and condition assessment information provide sufficiently accurate forecast renewal rates. The forecast renewal targets and renewal actions identified from condition assessments for each asset category are provided in the following sub-sections.

5.4.1 Subtransmission lines

LIFE CYCLE ASSESSMENT

ODV Standard Life (Wood/Concrete)	45/60 years
Population Size	2262 poles – 328km line
Steady state replacement rate	46 poles - 5km line
Start of failure period	44 years
Failure period duration	4 years
Average residual quantity	10 poles
Targeted replacement rate	40 poles - 0km line
Rate of Growth Additions/Upgrades	0 poles - 0kmline
Steady state less renewal/Upgrade gap	0km

In addition to the criteria identified by age/condition assessment, an entire section of line will be replaced as capital renewal if the total required maintenance expenditure exceeds 20% of the cost of new asset, i.e. for 50kV lines at \$70,000/km the ceiling for maintenance expenditure is \$14,000/km. This will include conductor renewal if existing conductor has less than 5 years remaining life.

This asset is critical to reliability and therefore replacement programs aim to renew asset before failure in service. In addition any known defects are to be dealt with within a year. If components are still failing in service, or the backlog of defects is increasing, then the planned replacement rate will be increased.

Summary of Actions

- Replace 40 poles per year steady state. \$200,000
- Age replacement for conductor assumes 75 year life hence no planned replacement is currently undertaken.
- OB Insulator Replacement \$30,000 p.a.
- NZED 2nd hand Insulator replacement \$30,000 p.a.
- Other component replacement allowance \$40,000 p.a.

5.4.2 11kV Lines and Cables

LIFE CYCLE ASSESSMENT (Lines)

ODV Standard Life	60 years
-------------------	----------

Population size	2454km
Steady state replacement rate	40km
Start of failure period	49years
Failure period duration	10years
Average Residual Quantity	30km
Targeted Renewal Rate	15km
Rate of Growth Additions/Upgrades	3km
Steady state less renewal/Upgrade gap	12km

LIFE CYCLE ASSESSMENT (Poles)

ODV Standard Life	45/60years
Population size	8604 Concrete & 18257 Wood
Steady state replacement rate	600
Start of failure period	42years
Failure period duration	10 years
Average Residual Quantity	100
Targeted Renewal Rate	300
Rate of Growth Additions/Upgrades	50
Steady state less renewal/Upgrade gap	250 poles

LIFE CYCLE ASSESSMENT (Cables)

ODV Standard Life	45-70 years
Population size	125km
Steady state replacement rate	2km
Start of failure period	50 years
Failure period duration	15 years
Average Residual Quantity	0
Targeted Renewal Rate	0
Rate of Growth Additions/Upgrades	2km
Steady state less renewal/Upgrade gap	0km

The 12km p.a. gap between steady state replacement rate of 40km of conductor per annum and the targeted renewal rate plus the replacement due to upgrade work, is identified as a long term issue for the conductor assets. The factors influencing the ability to address this issue include economic justification/regulatory revenue constraint, the availability of physical resources and controls on outages required to undertake the work.

In the medium term the effect of a shortfall in investment in renewal of 11kV conductor is addressed in part by ENL's strategy for uneconomic lines described in Section 4.7. In the long term renewal investment shortfall will affect ENL's ability to achieve customer expectations of steady state performance and regulatory performance targets

In addition to the criteria identified by age/condition assessment an entire section of line will be replaced as capital renewal if the total required maintenance expenditure exceeds 20% of the cost of new asset, i.e. at \$35,000/km the ceiling for maintenance expenditure is \$7,000/km. This includes conductor renewal and costs that reflect replacement of existing asset not new construction. Circuits of higher importance closer to major load are prioritised for replacement. I.e. Tie feeders have replacement programs starting at 50 years.

The gap of 250 poles p.a. between steady state replacement rate and targeted rate of 600 per annum plus the replacement due to upgrade work, is identified as a long term issue for 11kV pole assets. Similarly to 11kV conductor the factors influencing the ability to address this issue include economic justification, availability of physical resources and controls on outages required to undertake the work.

In the medium term the effect of constrained investment in renewal of 11kV poles is addressed in part by ENL's strategy for uneconomic lines described in Section 4.7. In the long term renewal investment shortfall will affect ENL's ability to achieve customer expectations of steady state performance and regulatory performance targets

Cable replacement is solely driven by the need for capacity upgrades and new work which is identified on a project-by-project basis. Therefore targeted replacement due to age is 0km. When multiple failures are experienced on sections of cable replacement is built into project work. Currently there are no projects specifically in this category.

Summary of Actions

- Until 2014 conductor replacement is scheduled at 15km pa. at a cost of \$390,000 pa. From 2013 to the end of the period conductor replacement is scheduled to increase to 30km pa. at a cost of \$900,000 pa. This allows for alignment with steady state

replacement targets and allows for the peak of the age profile installation pattern

- Uneconomic Rural line replacement is scheduled for 2009 to 2013 at 10km pa. costing \$300,000 pa.
- Target replacement of 300 poles at \$3666 ea. per year is planned until less than 10% of the wood pole population has remaining pole strength lower than the design load. \$1,100,000. p.a.

5.4.3 LV Lines and Cables

LIFE ASSESSMENT (Lines)

ODV Standard Life	45years
Population Size	534 km
Steady state replacement rate	11km/yr
Start of Failure period	45 years
Failure period duration	20 years
Average Residual Quantity	0
Targeted Renewal rate	1km
Rate of Growth Additions\ Upgrades	2km
Targeted Reduction rate	2km
Steady state less renewal/Upgrade gap	6km

LIFE ASSESSMENT (Poles)

ODV Standard Life	45years
Population Size	9381
Steady state replacement rate	200
Start of Failure period	35years
Failure period duration	20years
Average Residual Quantity	0
Targeted Renewal rate	50
Targeted Reduction rate	100
Rate of Growth Additions\ Upgrades	0
Steady state less renewal/Upgrade gap	50

LIFE ASSESSMENT (Cables)

ODV Standard Life	45 years
Population Size	197 km
Steady state replacement rate	4 km/yr
Start of Failure period	40 years
Failure period duration	10 years

Average Residual Quantity	1 km
Targeted Renewal rate	1 km/yr
Rate of Growth Additions/Upgrades	3 km/yr
Steady state less renewal/Upgrade gap	0km

Spot pole renewal will occur as a maintenance action indefinitely until there is a need to reconductor for capacity. At this time all poles will have to meet increased strength requirements to carry the heavier conductor. Where necessary underground conversion will be applied.

Summary of Actions

Renew Lines 1km/year (Assume 2km per year will be renewed with cable)	\$40,000 p.a.
Replace 50 poles per year at (It is assumed that 75 poles p.a. will be removed due to underground renewal)	\$100,000 p.a.
1km/yr Cable steady state for age renewal	\$80,000p.a.
2km/yr undergrounding as a substitute for line renewal.	\$150,000p.a

5.4.4 Service connections

Note ENL does not manage renewal.

In some cases expenditure is warranted to allow other work on network assets to proceed. This is allowed for within the funding provided for the other assets.

ENL is removing its equipment from private boundary-meter boxes and relocating into new service fuse boxes. Completion of this current issue is planned by 2010/2011 at \$30,000 pa.

5.4.5 Load Control

Total number of relays to eliminate the Contactor / Pilot System.

Gisborne	4755
Wairoa	2000

Renewal of 1200 relays at a total cost of \$250,000 p.a. is forecast until completion in 2010/2011

5.4.6 Zone substations

Renewal of fences, failing drainage, building renovations (e.g. roofing) and other significant land and building related items as identified from

condition inspections is allowed for at \$20,000p.a. until 2010 reducing to \$10,000p.a.

5.4.7 Zone Substation Transformers

As Zone transformers are considered critical assets renewal has been determined by consideration of each individual Transformer. Factors considered include external and internal condition, History of operation, development plans, losses, and age.

Transformers currently identified for renewal are as follows...

Year	Action	Cost
2008/2009	Replace T1 at Tolaga with 1x 2.5MVA 3-Phase	\$500,000
2009/2010	Replace T1 and T2 Patutahi with 1x 5MVA 3-Phase	\$500,000
2012/2013	Replace T1 Puha with 1x 5MVA 3-Phase	\$250,000

5.4.8 Circuit breakers

ODV Standard Life	40 years
Population size	180
Steady state replacement rate	4/yr
Start of failure period	35years
Failure period duration	10years
Average residual quantity	1
Targeted renewal rate	Discrete Program
Rate of growth/security additions	1/yr
Steady state less renewal/Upgrade gap	0

Replacement of CB's is justified on the basis of maintenance savings and risks of failure. The cost of major refurbishment overhauls of the CB's has been in the order of 25% of a new unit giving an expected 25% life extension. This has allowed the CB replacement program to be managed over a more controlled timeframe. More recently new CB costs have reduced hence refurbishment is now uneconomic by comparison with life expectancies.

50 kV Circuit Breakers

Location	Make	Cost	Replace
Te Araroa T1	Bulk Oil Metro Vic	\$80k	2008/09
Ruatoria T1	Bulk Oil Metro Vic	\$80k	2009/10
Line to TeAraroa	Bulk Oil Metro Vic	\$80k	2009/10

Location		Make	Cost	Replace
Tokomaru	T1	Bulk Oil Metro Vic	\$80k	2010/11
	Line to Ruatoria	Bulk Oil Metro Vic	\$80k	2010/11
Tolaga	T1	Bulk Oil Metro Vic	\$80k	2008/09
Carnarvon	T1	Reyrolle Min Oil	\$80k	2014/15
Makaraka	Line to Patutahi	Reyrolle Min Oil	\$80k	2015/16
	Inject Plant	Reyrolle Min Oil	-	2017+
Pehiri	Line to Ngatapa	Maier Bulk Oil	\$100k	2010/11

11 kV Circuit Breakers

Location	Make	REPLACE
Mata Rd	Coopers KFE	2014
Carnarvon Sub	Reyrolle LMT	2014
Carnarvon Sub	Reyrolle LMT	2014
Carnarvon Sub	Reyrolle LMT	2014
Carnarvon Sub	Reyrolle LMT	2014
Carnarvon Sub	Reyrolle LMT	2014
Carnarvon Sub	Reyrolle LMT	2014
Carnarvon Sub	Reyrolle LMT	2014
Carnarvon Sub	Reyrolle LMT	2014
Carnarvon Sub	Reyrolle LMT	2014
Carnarvon Sub	Reyrolle LMT	2014
Carnarvon Sub	Reyrolle LMT	2014
Carnarvon Sub	Reyrolle LMT	2014
Matawai	Coopers KFE	2014
Ruakituri	Coopers KYLE 3H	2006
Ruakituri	Coopers KYLE 3H	2006
Frasertown/Nuhaka	Coopers KYLE 3H	2006
Frasertown/Nuhaka	Coopers KYLE 3H	2006
Frasertown/Nuhaka	Coopers	2006

The Carnarvon Substation Oil filled moving portion (trucks) have been identified for renewal by routine maintenance assessments

The Coopers KYLE 3H rural CBs are being renewed as part of the rural automation program.

5.4.9 Distribution Transformers

ODV Standard Life	45 years	
Population Size		3547
	Small	Large
Steady state replacement rate	70 per year	13 per year
Start of failure period	38 years	45 years
Failure Period	10 years	5 years

Average Residual Quantity	10	1
Targeted Replacement Rate	50	12
Rate of Growth Additions	30	6
Targeted Renewal rate	50/yr	9/yr
Rate of Growth Additions/Upgrades	30/yr	4/yr
Steady state less renewal/Upgrade gap	0	0

Renewal costs are forecast at \$2600 each for small transformers and \$35000 each for large transformers. The expenditure incorporates an allowance for replacement fuses, minor circuit alterations and earthing work to accommodate the transformer renewal

Distribution substation and switch-station earthing renewal work is scheduled at \$4,000 p.a.

The low cost of new transformers, high cost of operating maintenance facilities and longer life expectancy of new transformers makes replacement the preferred option compared to traditional maintenance.

5.4.10 Pole Mounted Isolation Equipment

LIFE ASSESSMENT (ABS and SF6 SW's)

ODV Standard Life	35 years
Population size	596
Steady state replacement rate	22/yr
Start of failure period	38 years
Failure period	10 years
Average Residual Quantity	2
Targeted replacement rate	20/yr
Rate of growth additions	2/yr

LIFE ASSESSMENT (Fuses)

ODV Standard Life	35years
Population size	3570
Steady state replacement rate	84/yr
Start of failure period	42years
Failure period	7yrs
Average Residual Quantity	2
Targeted replacement rate	50/yr
Rate of growth additions less reduction	10/yr

Summary of Actions

Renew ABSs at a rate of 20/yr until 2008 (To minimise non compliant Quadrant Units)	\$115,000 p.a.
Steady state ABS renewal of 9/yr from 2008	\$52,500 p.a.
Renew 20 isolation fuses/links unit's p.a. until 2008	\$115,500 p.a.
Steady state fuse-set renewal of 6/yr from 2008	\$12,000 p.a.

Expenditure for transformer fuse replacement is included in the transformer renewal allowance at a rate of 40 sets p.a.

5.4.11 11kV Switchgear (ground mounted)

Standard ODV Life	40 years
Population Size (Operational Switches)	677
Start of Failure Period	1989
Failure Period	20 years
Average Residual Quantity	4
Average Installation Quantity	16/yr
Targeted Replacement Rate	15/yr
Rate of Growth Additions	15/yr

The following list details the priority replacements. The costs include associated cabling and alterations.

Year	Note	Location	Description	Cost
2006/07	tx	B347	Abbott St (Rotary)	\$11,500
2006/07		B359	Salvation Arm (rotary)	\$26,500
2006/07	tx	B147	Abbott St (Rotary)	\$11,500
2006/07		B515	Totara St (Rotary)	\$26,500
2006/07		B250	Wildash (Rotary)	\$26,500

Note tx : Total cost is less (\$35,000 allowance in Transformer Section)

Steady state annual replacements of 5/yr at \$36,000 are expected to commence from 2015.

5.4.12 LV Switchgear

ODV Standard Life	40 years
Population Size Link Boxes	330
Population Size LV Frames	350
Distribution Pillars	3250
Average Installation Quantity	14

Start of Failure Period	38
Failure Period	10
Average Residual Quantity	0
Targeted replacement rate	14
Rate of Growth Additions	6

If major repair is required the entire box is upgraded to current standards.

Replacement of J Type Lucy LV Boxes 6 boxes per year is targeted until 2008 at an estimated cost of \$40,000 p.a.

Funding for replacement of Lucy Frames is provided in transformer replacement funding.

There is an issue with fiber-glass Distribution boxes deteriorating due to ultra violet rays. There are 200 boxes of this type to be replaced, i.e. 50/year @ \$850 each - \$40,000p.a. until 2010/2011.

5.4.13 Control and protection

Protection equipment traditionally lasted the life of the device it protected. However as protection schemes are required to co-ordinate across both ENL's network and Transpower's points of connection, protection equipment must maintain technical and functional compatibility with ENL's and/or Transpower's latest protection operating standards. Generally this results in protection equipment requiring technology upgrading before age or condition replacement.

Voltage regulators are currently fitted with mercury filled switch mechanisms. Replacement with PLC controls is planned when the existing units show signs of mal-operation due to mechanical wear forecast details are as follows

Tap change control relays provided by IMP with earlier transformer purchases have proved unreliable requiring 2 or 3 recalibrations or component replacements per year. Failure of the controls causes deviation from required voltage delivery parameters and in rare cases tripping of the transformers.

Station	Tapchanger/AVRControl/ RenewalDate	Cost \$
Pehiri	2010/2011	* Pehiri CB Change
Ngatapa V_Reg	2007/2008	* TX Change
Patutahi	2009/2010	* TX Change
Pehiri V_Reg	2007/2008	5,000
Kopuroa V_Reg	2008/2009	5,000
Waihua V_Reg	2008/2009	5,000
Matawai V_Reg	2009/2010	5,000
Waingake V_Reg	2009/2010	5,000
Kanakania V_Reg	2009/2010	5,000
Tatapouri V_Reg	2007/2008	5,000
Allowance	2013+	5,000

* Costs included with other project work

Rural Automation sites operate either 12 or 24V DC battery systems the average Annual cost to maintain Batteries and Charges at these sites is \$3000 p.a.

Substation systems include the 110V banks and 24V systems incorporating redundancy with Dual 24V chargers and Batteries. The steady state cost to maintain Batteries and Charges at these sites is \$12000 p.a.

Station	Feeder Protection RenewalYear	Transformer Protection Renewal Year	50KV Protection Renewal Year
Kiwi	2013/14 \$80k	2013/14 \$14k	2013/14 \$6k
Carnarvon St	2007/08 \$90k	2024	2024
Parkinson St	2008/09 \$80k	2024	2024
Kaiti	2009/10 \$80k	2024	2024
Port	2022	2022	2022
Makaraka	2021	2021	2021
Tokomaru	2020	2018	2018
Tolaga	2021	2020	2020

Puha	2021	2021	2021
Pehiri	N/A	N/A	N/A
Ngatapa	N/A	N/A	N/A
Patutahi	2020	2006/07 \$14k	2006/07 \$6k
Te Araroa	2020	2021	2021
Ruatoria	2021	2021	2019
Matawhero	2020	2020	2020
Wairoa	N/A	2020	N/A

Steady state allowance of replacement of components following premature failure is assumed at \$10,000p.a.

5.4.14 Communications

Generally technology upgrade occurs before age or condition replacement; however ENL's strategy has been to defer the renewal until such time as the operational performance and condition of the equipment necessitates the change.

As the Radio communications network is predominantly radial in nature benefits of the new technology incorporated into the new equipment can be released sooner if the network is replaced starting at the communications hub spreading outwards to the remote regions. Equipment removed, in some cases, that has some remaining service life is relocated to the remote areas for the short term if necessary until renewal is appropriate.

In 2006/2007 specific expenditure of \$80,000 has been forecast to address the communications bottle neck between Carnarvon St and Whakapunaki as part of the equipment renewal.

Forecast expenditure is provided at \$60k p.a from 2007/08 to progressively renew the radio communications assets.

Cable circuits will not be renewed.

Fibre Optic circuits installed between 2002/2006 are expected to survive the planning period of this plan before renewal is required.

An allowance of \$20,000 p.a. is provided for unplanned renewal as a result of premature failures.

5.4.15 SCADA

The original GPT master station and data-term RTU's were replaced between 2000 and 2002 with the current Abbey system. No planned replacements for the Abbey equipment are expected until 2010. At this time a 3 year program to renew the equipment is planned at a cost of \$120,000 per year.

Unplanned renewal of failed equipment should assume \$12000 p.a. between major upgrades.

Scada monitoring and control of radio repeater sites is currently carried out using a Secom system which requires replacement due to mal-operation of the units. A renewal provision of \$30,000 is provided in 2008/09.

5.4.16 Generators

Renewal timing and costs for standby generation assets associated with communication and SCADA assets are as follows...

Generator Location	Renewal Date	Cost
Carnarvon St	2016	\$20,000
Makaretu	2016	\$10,000
Arakihi	2016	\$10,000
Mata Rd	2016	\$10,000
Whakapunaki	2016	\$10,000
Tikitiki	2016	\$10,000

5.5 Up-sizing or extending the assets

If any of the capacity triggers in Table 4.1.3(a) are exceeded ENL will consider either up-sizing or extending the network. These two modes of investment are, however, quite different as described in Table 5.5(a) below.

Table 5.5(a) – Distinguishing between up-sizing & extension

Characteristic	Up-sizing	Extension
Location	Within or close to existing	Outside of existing network

	network footprint (within a span or so).	footprint (more than a few spans).
Load	Can involve supply to a new connection within the network footprint or increasing the capacity to an existing connection.	Almost always involves supply to a new connection.
Upstream reinforcement	Generally forms the focus of up-sizing.	May not be required unless upstream capacity is constrained.
Visible presence	Generally invisible.	Obviously visible.
Quadrant in Figure 4.1.2(b)	Either 1 or 2 depending on rate of growth.	Either 3 or 4 depending on rate of growth.
Necessity	Possible to avoid if sufficient surplus capacity exists. Possible to avoid or defer using tactical approaches described in section 4.2.1.	Generally can't be avoided – a physical connection is required.
Impact on revenue	Difficult to attribute revenue from increased connection number or capacity to up-sized components.	Generally results in direct contribution to revenue from the new connection at the end of the extension.
Impact on costs	Cost and timing can vary, and be staged.	Likely to be significant and over a short time.
Impact on ODV	Could be anywhere from minimal to high.	Could be significant depending on length of extension and any consequent up-sizing required.
Impact on profit	Could be anywhere from minimal to high.	Could be minimal depending on level of customer contribution.
Means of cost recovery	Most likely to be spread across all customers as part of on-going line charges.	Could be recovered from customers connected to that extension by way of capital contribution.
Nature of work carried out	Replacement of components with greater capacity items.	Construction of new assets.

Despite the different nature of up-sizing and extension work, similar design and build principles are used as described in section 5.5.1.

The forecasts for new assets and asset extensions other than those identified in the development program are difficult to predict as they are generally short term customer driven activities. Section 5.5.2 identifies the predictions for these activities.

5.5.1 Designing new assets

ENL uses a range of technical and engineering standards to achieve an optimal mix of the following outcomes...

- Meet likely demand growth for a reasonable time horizon including such issues as modularity and scalability.
- Minimise over-investment.
- Minimise risk of long-term stranding.
- Minimise corporate risk exposure commensurate with other goals.
- Maximise operational flexibility.
- Maximise the fit with soft organisational capabilities such as engineering and operational expertise and vendor support.
- Comply with sensible environmental and public safety requirements.

Given the fairly simple nature of the network ENL tends to adopt standardised designs for all asset classes with minor site-specific alterations. These designs, however, will embody the wisdom and experience of current standards, industry guidelines and manufacturers recommendations.

5.5.1.1 Subtransmission Lines

Construction of new or replacement asset will adhere to following standards...

- Concrete poles (unless limited by weight for helicopter installations)
- Cross-armless delta configuration, and cross-armless angles for live line compatibility
- If phase separation dictates use of crossarms, then steel arms with flat post insulator construction are used
- Polymer strain insulators – no strings

- No LT under building
- Avoid main highway line routes
- Standard conductors: Cockroach – urban, Dog – rural
- All poles to be fitted with possum guard
- Line make-offs/staying approximately every 12th pole if there are no intermediate make-offs or angles
- Conductor spacing and insulation to minimum 66kV standard

5.5.1.2 Distribution Lines and Cables

Construction of new or replacement asset will adhere to following standards...

Lines

- Concrete poles (hard wood poles where load/strength characteristics cannot be matched)
- Crossarms mounted 200mm below top of pole
- Longer crossarms (2.4m) for live line friendly spacing
- Polymer strain insulators – no strings or kidney
- Line routes to adhere to road reserve where possible
- Standard conductors - Dog – Urban and Rural ties
- Insulators to minimum 15kV standard and for coastal areas 25kV
- Insulators fitted 100mm in from crossarm ends
- All poles to be fitted with possum guard, and pole cap if wooden
- Hardwood strain pole required every 2km in straight prop pole sections of line (to break cascade failures)
- Angle poles to be armless for live line capability.
- Mid span jumpers not permitted
- No stub poles to be used for stay anchors

Cables

- No pitch terminations to be reinstated if any work undertaken
- Terminations on poles to be protected with surge diverters
- Standard cable sizes: 300mm 185mm 95mm AL ,16mm CU
- No cable to cable T connections

5.5.1.3 LV Lines and Cables

Construction of new or replacement asset will adhere to the following standards...

- No reinstatement of pilot
- No reinstatement of O/H street lighting
- Wasp PVC covered conductor for overhead
- Beetle (106mm²) domestic cabled LV reticulation
- Huhu (185mm²) commercial cabled LV reticulation
- 25mm² NS Cu. For road crossings
- No under-building on 50kV poles
- Cables to be run for first span from distribution sub.
- No more than 1 termination per pole.
- Designs to consider elimination of road crossings, overhead crossovers, mid span jumpers and substation by-pass via overhead circuit.

LV conductors are fused to full duty capacity, i.e. no short duration duty cycle peaks are permitted. This prevents accidental overload as no monitoring is undertaken and there is little control over the load connected in customers' installation. No de-rating is made for damage, aging or trenching conditions. This sets the upper limits on conductor capacity at rating.

The low level of protection and management of load is traded off against longevity of service.

Overhead conductor is installed with an excess contingency capacity of 20% while cables have a contingency capacity of 33%. This contingency erodes with load growth until load equals rated capacity.

5.5.1.4 Service Connections

Domestic installations have traditionally been supplied via 4 wire (2 phases, pilot, and neutral) service lines. This was a means of keeping conductor size small by meeting capacity requirement via more conductors.

Single phase connections, without pilot, are the preferred standard. This reduces the quantity of connection hardware by 66% and reduces the probability of equipment failure. This will be encouraged at the time of upgrades via a differential in fixed charges for multi phase versus single phase connections.

- All new connections and upgrades will encourage undergrounding by providing the point of connection in a boundary located service fuse box, i.e. installation of pole fuses will be discontinued. This cleans down the structures of hardware, aids

- accessibility, and prepares the way for under grounding the main line.
- Pole fuses will still be permitted in rural areas however preferred connection will be via cable only to eliminate pole loading issues.
 - For customers not wishing to underground a UDOS pole located on their property is an alternative.
 - During renewal programs no pilot wire will be reinstated. The installation will be converted to ripple control.

5.5.1.5 Zone Substations

Earthing at Zone substations is carried out in accordance with the codes of practice. In general 70mm² CU conductor is used with cad-weld connections and copper-clad rods driven at each conductor intersection. The design of the grid is specific to each site and varies depending on soil re-sensitivity factors.

The requirement for bunding is determined by the quantity of oil that could spill in the event of a single rupture. For equipment with low oil quantities less than 200 litres oil spill kits and spill procedures provide for containment and clean-up to minimise environmental damage. Equipment that falls into the low oil quantity category includes switchgear and distribution transformers. For high oil quantities the work comprises, installation of concrete oil containment areas and the installation of oil separators to separate oil from the storm water under normal operating conditions. The requirement for oil containment at a site is dependant on the quantity of oil that could be spilt in any single event.

New building standards include raised buildings (approx 1 meter) to reduce risk from flooding and allow cable access from underneath.

Where wooden duct covers have been used and have begun to deteriorate they are being replaced with metal covers to reduce fire risks and the chance of failure under load. Alterations carried out on the buildings, as maintenance is required include the removal of windows in buildings where indoor 11kV switchgear is used and replacement of wooden doors and window frames with low maintenance aluminum fittings.

The layout of substation yards has been designed to allow crane access for installation and removal of the large transformer without interference from the overhead 11kV and 50kV lines

Oil spill kits and handling procedures are located at all zone substations to cope with oil spills from circuit breakers with lower oil quantities.

5.5.1.6 Zone Substation Transformers

- New transformers require secondary oil containment and oil separation equipment per District Plan.
- Earthquake mountings are required to have engineering certification. Connections to bushings are also designed for earthquake tolerance.
- Noise standards as controlled to requirements of the District Plan

Standard incremental Zone substation sizes used on the network are 2.5, 5/7, 12.5MVA.

Standardisation on the purchase of low cost IMP transformers from India with on site supervision of the construction has proved successful to date. Continued purchases are planned in future.

Alterations carried out on the initial IMP design that are now incorporated into new purchases include...

- Anti vibration pads between transformer and concrete pad
- Separate tap changer and transformer oil compartments in conservator tanks.
- Pressure relief valves in addition to the Buchholtz fitted to both the transformer and tap changer.
- Less than 1.5% transformer losses
- A spare tap changer is held for contingency purposes.

As opportunity permits new transformer purchases in rural locations will comprise smaller capacity 3-phase units, which allow compact substation design and reduced maintenance over the life of the units.

5.5.1.7 Circuit Breakers

Insulation levels are maintained within the manufacturer's specifications and are measured with discharge monitoring equipment or during servicing.

Indoor 11kV circuit breakers used for all Substations where multiple feeders are necessary.

Bypass and isolation arrangements are installed for 50kV CB's where no alternative supply is available.

Incomer and bus section configurations are used where dual transformer configurations exist.

All circuit breaker/feeder ratings are twice the normal feeder load to allow support of adjacent feeder loads.

50 kV Circuit Breakers

Bulk oil circuit breakers are located within bunded containment areas.

Outdoor CB's are used for all 50kV applications.

New 50kV CB purchases have been standardised for compatibility and reduced long term costs. Standard features include:

- SF6 outdoor
- 66kV rated minimum
- DC 24 volt operation (reduces 110V DC battery costs currently incurred due to older CB designs)

11kV Circuit Breakers

- Min 400A rating and 12kA short time fault rating
- SF6 or Vacuum
- Indoor configurations for multiple feeder substations.
- Bursting discs fitted to outdoor reclosers (requirement from previous failure issues)
- Electronic protection with fully configurable curve types and settings including DNP3 or Modbus communications capabilities.
- 24v DC operating mechanisms
- Live line installation standard with bypass features using hot stick techniques
- SCADA control fitted to all remote recloser installations.
- Inclusion of Fault locators into recloser and protection schemes is also planned to optimise the overall network performance

The co-ordination density criteria for CB's, reclosers, sectionalisers, and fuses are as follows...

- Feeder CB per each substation feeder
- Field CB not more than 2 cascaded from Feeder CB
- Sectionalisher not more than 1 cascaded from Field CB
- Fuses Branch fusing on private spur lines

5.5.1.8 Distribution Transformers

All transformer installations are designed to allow restoration within 8 hours.

In most cases portable generation is temporarily used to supply load during replacement of larger transformers.

The security standards adopted by ENL do not allow for temporary supply of loads as a result of smaller transformer failure.

Earth resistances step and touch and equal potential bonding standards are in accordance with the electricity act and regulations.

To upgrade earths a maximum of 6 rods (2 banks) are driven before an earth is abandoned as impractical to lower resistance. These situations are reviewed on a case by case basis as the occurrence is rare.

Strength requirements for pole mounted substations are in accordance with the outcomes of the Visim design tool.

Replacement of transformers with ground mount mini sub style units is the standard practice for transformers over 100kVA Smaller ground mount transformers are also used for replacements in rural locations where the supply is via underground 11kV cables.

- Standard transformer sizes used are 15 kVA for 1 phase supplies 30, 50, 100, 200, 300, 500, 750, 1000 kVA for 3 phase.
- All transformers above 100kVA to be ground mounted.
- All new urban substations to be ground mounted regardless of size.
- LV isolation to be provided.
- All Urban LV connections to be cable.
- Transformers greater than 500kVA shall have 3-Phase switching provided for connection and disconnection, on the HV

5.5.1.9 Pole mounted Isolation equipment

Standards for Air Break Switches include...

- installations that accommodate live line replacement and maintenance techniques
- 900mm Phase separation on 11kV
- 1400mm phase separation on 50kV
- arc suppression fitted if connected capacity >1MVA on 11kV
- 50kV not used to break load unless fitted with suppression
- load break fault make rating on all new purchases

No transformers greater than 500kVA are installed using fusing protection in overhead areas.

Where sectionalisers or similar equipment are not present on rural lines air break switches are considered necessary at distances not exceeding 10km with typical connection densities of 20 to 30 per section.

Standards for Ground-mount switch installations include...

- No more than 3 transformers supplied from 1 switchboard without bus section
- Not more than 500kVA fed from switchgear supplied from a single cable circuit (excluding industrial situations)
- No more than 2 transformers and associated switchgear cascaded with no back feed
- Not more than 1 cable circuit connected directly to the bus of a switchboard arrangement.
- SF6 or Vacuum type equipment used for replacement to reduce maintenance.

11kV switchgear standards

- Extendable
- Extra height for termination ground clearance
- Independently mounted from transformer.
- 3 phase operation
- Fault make /load break
- 200A fuse tee off rating min.
- 400A Bus bar rating min.
- 12kA short time fault rating min.

5.5.1.10 LV Switchgear

New LV panel installations are constructed using DIN style equipment which is mounted independently from the transformer. Incomer links are fitted to provide the ability to isolate between the transformer and the LV bus bars. This facilitates easy removal and replacement of failed transformers.

400V tie switches are not normally installed on overhead networks interconnections are made using portable jumper sticks in fault conditions. In underground domestic reticulation boltable tie connections are made available at the open points of the LV runs.

5.5.1.11 Control and Protection

New purchases of protection relays include standardisation in terms of flexibility in protection scheme design, communication using standard serial I/O protocols and interchangeable hardware.

It is desirable to keep protection equipment and design consistent across the entire network. Therefore replacement programs need to be concentrated into a 5-year timeframe.

For Transformers up to 5MVA Overcurrent /Earth Fault protection is sufficient.

Transformers over 5MVA are to have Restricted Earth fault and Differential Protection.

110V battery banks installed as single unit.

Dual 24V Battery systems are to be used where installed CB's operate on 24V and no 110V systems are installed. 24/12-volt DC-DC converters used for Radio equipment power supply.

Battery chargers and batteries including rationalisation of various supply voltages to a common voltage (i.e. 12 volt, 48 volt supplies standardised at 24volts)

Tap changer controls shall be capable of Master/ Follower or circulating current operation to cope with unbalanced conditions.

Remote manual controls are installed on tap changer controls at Zone Substations and on Voltage Regulators to allow operator intervention when automatic control relays malfunction or when voltage adjustments are necessary when paralleling between to zone substations.

5.5.1.12 Communications

Construction of new or replacement asset will adhere to following standards...

- Telecom circuits 10kV isolation on all sites.
- Eastland Network pilot communications circuits 10kV isolation at all sites.
- LTCSS tone calling on all RT's
- Equipment at each end of a link to be same make, model and age.
- Power levels standardised on all repeaters at 25W. (Digital links 10W)
- Detachable head RT's to be used in vehicles.

5.5.1.13 SCADA

Correct operation of the SCADA system has a direct impact on the service levels and supply restoration response times. As such the reliability requirements of the system are high.

Dual master stations, remote master connection, sub master and island operating capabilities are directly targeted at robustness of the system to faults.

The poll duration of a single SCADA port increases with the number of RTU's connected to the port. When operating remote equipment from the control room maximum poll durations of 35 seconds are targeted to ensure effective operation and feedback from the equipment being controlled. A maximum of 25 RTU's per port is necessary to achieve the targeted poll duration.

Systems connected with the SCADA system must be selected to consider use of consistent Protocols

- DNP3
- MODBUS
- ABBEY

5.5.2 Building new assets

ENL uses external contractors to up-size or extend assets. As part of the building and commissioning process ENL's information records will be "as-built" and all testing documented.

The forecasts for new assets and asset extensions other than those identified in the development program are identified for each asset category as follows...

Distribution

The majority of distribution funding is specifically identified in the development program. Customer driven funding for distribution lines and cables is identified as follows...

11kV Lines	1km	\$90,000p.a.
11kV Cable	1km	\$200,000p.a.

In most cases this funding only contributes to a portion of the total project funded by the private developer or customer. The contribution provides for the cost of increases in line or cable size beyond the

minimum required for the customer which will provide for growth over the applicable planning period

LV growth

Detailed analysis has not been undertaken on the urban overhead network to identify exact capacity constraints. The cable network, which supplies commercial areas, is monitored more closely.

The trigger for upgrade is therefore a fuse blowing. Voltage complaints and transformer MDI readings can give an early warning. With load growth ranging between 0.5 and 11% it can be expected that in many cases conductor and cable will require capacity upgrade long before age replacement.

At present ENL is addressing capacity via additional transformer installation.

In the interim growth on these cables erodes contingency capacity.

An annual provision to accommodate organic growth is made to install 1km of LV (urban/commercial) cable at \$80,000.

Transformers

Allowances for additional transformers and capacity upgrades per year to cater for typical growth are as follows. Negative growth or shifting of load centers creates redundancy of transformer installations.

Large Transformers greater than or equal 100kVA 3 at \$140,000p.a.

Small Transformers less than 100kVA 20 at \$78,000p.a.

Switchgear ground mounted

Growth associated with this switchgear is triggered by industrial load or underground subdivision development. There are no constraints associated with the switchgear as the equipment is rated appropriately to the feeder capacities.

General subdivision development is underway, allowance for 3 units or 9 switches per year is sufficient.

Industrial growth is higher and allowance for 2 units or 6 switches per year is predicted.

15 switches per year at \$5,400 each=\$81,000

LV Frames

Allowance is made for 6 frames per year at \$40,000p.a.

Capacity upgrades assume reuse of existing LV frames.

Frame Installation as required with transformers.

Growth contingency allows for 6 new Boxes per year.

Installation of new Distribution boxes as ENL removes its connection fuses from Meter boxes located on customer boundaries is covered in the renewal section of this plan

Communications

Allowance for 4 additional automated sites per year from 2010/11 onward is considered sufficient for long term development. These communications costs are included in the Scada section.

Scada

As the number of sites increases on the network the capacity of the Abbey Master station will be increased. Functionality improvements of the system are also being developed on an ongoing basis to keep the system current. Ongoing development over 10 year cycle between system replacements should assume an average annual cost of \$10,000.

Development of a solar powered RT call in system use with fault locators was initially included as part of the rural automation program. Due to delays in production of a suitable system the expenditure from the rural automation program was deferred The system is designed to activate call-in indication following a fault to provide information of the fault location and assist with route planning for dispatch of fault staff to remote locations.

To complete the development the following funding has been provided...

2007/2008	\$48,000
2008/2009	\$50,000
2009/2010	\$50,000

Development of additional sites following completion of the rural automation program is forecast from 2010/11 costs are inclusive of Scada, communications and Actuator equipment \$20,000p.a.

5.6 Retiring of assets

Retiring assets generally involves doing most or all of the following activities...

- De-energising the asset.
- Physically disconnecting it from other live assets.
- Curtailing the assets revenue stream.
- Removing it from the ODV.
- Either physical removal of the asset from location or abandoning in-situ (typically for underground cables).
- Disposal of the asset in an acceptable manner particularly if it contains SF₆, oil, lead or asbestos.

Key criteria for retiring an asset include...

- Its physical presence is no longer required (usually because a customer has reduced or ceased demand).
- It creates an unacceptable risk exposure, either because its inherent risks have increased over time or because emerging trends of safe exposure levels are declining. Assets retired for safety reasons will not be re-deployed or sold for re-use.
- Where better options exist to create similar outcomes (eg. replacing lubricated bearings with high-impact nylon bushes) and there are no suitable opportunities for re-deployment.
- Where an asset has been up-sized and no suitable opportunities exist for re-deployment.

6. Managing the risks to the business

ENL's business is exposed to a wide range of risks. This section examines these risk exposures, describes what ENL has done and will do about these exposures, and what ENL will do when disaster strikes.

6.1 Understanding the business risk profile

Arrangements for Eastland Infrastructure to provide all management and support services for the three companies, (Eastland Infrastructure Ltd, Eastland Network Ltd and Eastland Port Ltd) which are all owned by the Eastland Community Trust was implemented in 2003. A new management structure was developed with new appointments being made to a number of management positions at this time.

The change in company size and structure altered the business risk profile of Eastland Infrastructure and the companies it manages. To facilitate the ability to manage risk in an efficient and effective manner in August 2004 RHS Services was engaged to carry out a comprehensive risk management review. The scope of this review was that in accordance with the Risk management Standard AS/NZ 4360:1999, the business operations of the three businesses were reviewed against a generic set of risk areas, (Governance, Personal, Financial, Business Development, Environmental, Political, Legal, Operational, Information, Technological and Business Resilience).

Having identified risks and associated existing mitigation practices, analysis was undertaken to determine likelihood (frequency or probability) of the risk occurring and the consequence (impact or magnitude of the effect) should the risk occur. By aggregating the likelihood and consequence, risk significance was assessed both with existing treatments applied and with any additional mitigations/treatments applied. This provided a measure/review of the effectiveness of current and future risk management for each business.

Further, based on the company's appetite for risk, a weighting was applied to each risk and a prioritized list of risk management actions has been developed. This list of actions has been incorporated into annual business plans and summarizes EIL' business risk management planning.

SUMMARY OF EIL RISK MANAGEMENT ACTIONS

Business Risk Identification & Analysis Report August 2004 (EIL BUSINESS RISK)

Action No. From Report	Risk Area	Description	Business Unit	Timing Priority	Responsibility	Comments
Refer Report RM2.3.#.#			EIL, ENL, EPL			
RM1.1	Governance	1. Develop internal auditing processes to assure compliance with the "Corporate Governance Charter".	EIL	C	CEO	Board review completed
RM1.2	Governance	2. Review the corporate governance framework in light of the business needs and any direction given from the Securities Commission.	EIL	C	CEO	Board review completed
RM2.1	Governance Business Objectives	1. Develop a monitoring and review process to ensure that all business initiatives and projects, policies and procedures are in compliance with the business objectives.	EIL, ENL, EPL	C	Corporate Service Mgr	Board review completed
RM3.1	Personnel	1. Review and update EI health and safety programme, including stress and fatigue policies, and public safety.	EIL	A	Marine Services Manager & Operations Manager	carry out a review of gaps for EPL and ENL
RM3.2	Personnel	2. Review and update EI's employment policies and procedures.	EIL	B	CEO, PA	
RM3.3	Personnel	3. Develop processes to include company needs analysis, recruitment and retention, employee performance review, and training policies / plans to provide for staff development and succession planning.	EIL	B	CEO,PA	
RM3.4	Personnel	4. Develop procedures to assist those staff nearing retirement to transition out the organisation whilst at the same time capturing their EI intellectual knowledge.	EIL	C	CEO GM Network Operations Marine Service & Ops Manager	
RM3.5	Personnel	5. Develop processes in the Gisborne region to foster a pool of resources to replace those who leave the organisation.	ENL, EPL	C		
RM3.7	Personnel	7. Benchmark ENL standards against industry best practice for public safety and unauthorised access.	ENL	A	GM Network Operations Corporate Service Mgr & GM Operations Mgr	
RM4.1	Financial	1. Review and update financial asset register and undertake regular reviews against other asset registers such as GIS.	ENL	C (Ongoing)		
RM4.2	Financial	2. Review and update port asset register.	EPL	C (Ongoing)	Marine Services & Operations Manager	
RM4.3	Financial	3. Gain decision from the Auditor General on status of the port for auditing purposes.	EPL	Completed	Corporate Service Mgr	Audit confirmed Port operations is not viewed under Port Act
RM4.4	Financial	4. Review methods to improve tracking of goods which use the port facilities.	EPL	C (Ongoing)	Commercial & Regulatory Manager	
RM5.1	Financial - Insurance	1. Implement three-yearly assessment as to whether the incumbent broker is providing a competitive service which meets the business objectives.	EIL	B	Corporate Service Mgr	Review for next financial year
RM5.2	Financial - Insurance	2. Undertake catastrophe reviews to assess the likely losses to business from the range of potential catastrophic events and procure insurance to match these losses.	ENL, EPL	C	GM Network Operations Marine Service & Ops Mnger	Stage 1 update Disaster Plans & review risks
RM5.3	Financial - Insurance	3. Review deductible levels against a risk management framework and the company's risk appetite.	ENL, EPL	C (Ongoing)	GM Network Operations Marine Service & Ops Mnger	

RM5.4	Financial - Insurance	4. Review contract works insurance and contracted terms and conditions to assess whether the contractors are already including an allowance for this insurance.	ENL	C	GM Network Operations	Include as part of the Contract reviews see RM21 Process documented and Board included in the development of business cases and aware of level of risk assessment undertaken
RM6.1	Business Development	1. Undertake a robust and rigorous risk assessment of new business initiatives prior to any commencement of new business activity. This assessment should include how the initiative fits with existing business operations and business objectives.	EIL	C	Commercial & Regulatory Manager	
RM6.2	Business Development	2. Actively become involved in industries on the East Coast looking for new opportunities for EI growth.	EIL	C	Business Development Manager	
RM7.1	Environmental Natural Events	1. Review of all significant natural events to assess EI's vulnerability and potential loss.	ENL, EPL	B	GM Network Operations	
RM7.2	Environmental Natural Events	2. Undertake a flood review using the territorial authority's flood plans to estimate the likely critical points and likely damage on ENL's network for the various flood scenarios. This could also include a landslide analysis.	ENL, EPL	B	GM Network Operations	
RM7.3	Environmental Natural Events	3. Undertake an earthquake review using likely earthquake scenarios to assess the potential level of damage to the electricity network and port operations.	ENL, EPL	B	GM Network Operations	
RM8.1	Environmental Emissions	1. Maintain a register of all land use rights and obligations. This would include acceptable noise and emissions limits.	ENL, EPL	A	Commercial & Regulatory Manager & GM Network Operations Manager	Port and Tolaga Bay
RM8.2	Environmental Emissions	2. Prepare a register of sites which are contaminated.	ENL, EPL	B	GM Network Operations & Commercial and Regulatory Manager	
RM9.1	Environmental weather affecting ENL	1. Actively pursue options to reduce dependency on hydro electricity.	ENL	C (Ongoing)	GM Network Operations	
RM10.1	Environmental weather affecting EPL	1. Improve systems to forecast future weather events to reduce their impact on port operations.	EPL	A	Marine Services & Operations Manager	
RM11.1	Political	No additional treatments are necessary at this time.				
RM12.1	Political Terrorism	1. Actively monitor evidence of increasing terrorist threats.	EPL	C	Marine Services & Operations Manager	
RM13.1	Political - Lobby Groups	1. Further involvement in engaging lobby groups in discussion / consultation as part of the planning process for any new initiatives.	ENL, EPL	C (Ongoing)	CEO	The ISPS sets high standards for compliance and monitoring threats
RM13.2	Political - Lobby Groups	2. Actively communicate with local government to highlight interests of ENL and EPL.	ENL, EPL	C (Ongoing)	CEO	
RM13.3	Political - Lobby Groups	3. Use the media to positively portray ENL and EPL interests.	EIL, ENL, EPL	C (Ongoing)	Marine Services & Operations Manager	
RM14.1	Political - Industry Groups	No additional treatments are necessary at this time.			CEO	

RM15.1	Political - Government Intervention	No additional treatments are necessary at this time.			CEO	
RM16.1	Political - EI Owners	No additional treatments are necessary at this time.			CEO	
RM17.1	Legal - Contractual	1. Work collaboratively with Transpower to develop a more reliable transmission system into the Gisborne Region that meets ENL's business objectives.	ENL	A	GM Network Operations	Currently evaluating issues & options with Transpower. Will work with the industry as the Model UOS develops. Need to look at contracts with large industrial consumers
RM17.2	Legal - Contractual	2. All electricity retailer agreements / relationships should be reviewed against the Model Use of System contract and EI's business objectives.	ENL	C (Ongoing)	Commercial & Regulatory Manager	
RM17.3	Legal - Contractual	3. Develop a new contract arrangement on a progressive basis with all service providers. Include in the contract:	ENL, EPL	A	Commercial and Regulatory Manager	
RM17.3	Legal - Contractual	i. a performance management system which aligns the contractors objectives with those of ENL and / or EPL,		A	Commercial and Regulatory Manager	
RM17.3	Legal - Contractual	ii. factors such as quality, health and safety, reliability, reporting, asset information, processes and customer service, and		A	Commercial and Regulatory Manager	
RM17.3	Legal - Contractual	iii. acknowledgement of the East Coast isolation and lack of competitive tension.		A	Commercial and Regulatory Manager	
RM17.3	Legal - Contractual	iv. Any pre-qualification, tendering processes must be communicated to all interested parties and be robust, fair and transparent.		A	Commercial and Regulatory Manager GM Network Operations & Commercial and Regulatory Manager	
RM17.4	Legal - Contractual	4. Review all lease and license arrangement and develop a process to align them with the business objectives.	ENL, EPL	C (Ongoing)	Commercial and Regulatory Manager	Work ongoing
RM18.1	Legal Statutory Rights & Breach	1. Enlarge the legislative compliance audit to include all relevant legislation.	EIL, ENL, EPL	B	CEO	Further work needed for ENL
RM18.2	Legal Statutory Rights & Breach	2. Enlarge the legislative review to cover all businesses.	EIL, ENL, EPL	B		EPL is completed
RM18.3	Legal Statutory Rights & Breach	3. Review the concept of "duty of care" as the public becomes more litigious.	EIL, ENL, EPL	B	CEO	
RM18.4	Legal Statutory Rights & Breach	4. Identify all statutory rights which EPL and ENL have, and actively work with stakeholders to maintain these rights.	ENL, EPL	A	Commercial and Regulatory Manager	Need to include local body plans and port etc. EIL use INSIGHT to provide advice on DP and LP. Including assistance with formal submissions
RM18.5	Legal Statutory Rights & Breach	5. Complete all recommended actions from the MSA (Jody F Millennium) accident report.	EPL	Completed	Marine Services & Operations Manager	
RM19.1	Operational ENL	1. Develop benchmarking of asset management practices against other similar network companies.	ENL	C	GM Network Operations	The existing disclosure (AMP) process is demonstrating

							compliance with best practice
RM19.2	Operational ENL	2. Actively work with stakeholders to reduce likelihood and severity of car accidents and other third party damage to the network.	ENL	C	GM Network Operations		Statistics on post events to be collated To be completed in conjunction with Network Development Plan
RM20.1	Operational ENL Uneconomic Lines	1. Monitor and manage public perceptions as ENL disposes of uneconomic lines.	ENL	C	GM Network Operations		
RM21.1	Operational EPL	1. Develop an Asset Management Plan (AMP) for the port assets, possibly following the framework developed for ENL.	EPL	A	Marine Services & Operations Manager		
RM21.2	Operational EPL	2. Develop a capital expenditure plan to manage the new build and asset replacement.	EPL	A	Marine Services & Operations Manager		
RM21.3	Operational EPL	3. Develop systems, policies and procedures to design installations that meet the current prudent standards of design.	EPL	A	Marine Services & Operations Manager		
RM21.4	Operational EPL	4. Implement documented project management practices to achieve project objectives.	EPL	A	Marine Services & Operations Manager		
RM21.5	Operational EPL	5. Undertake documenting of asset information on all port assets to limit loss or damage.	EPL	A	Marine Services & Operations Manager		
RM22.1	Information	1. Implement formal process to check asset information for accuracy before entering into databases.	ENL, EPL	B	GM Network Operations		
RM22.2	Information	2. Transfer all hardcopy record to soft copy versions for ease of backups and storage.	ENL,EPL	B	GM Network Operations		Information Mgr to develop policy & procedure and implement Information Mgr to develop policy & procedure and implement
RM22.3	Information	3. Systematically record information on all port assets.	EPL	A	Marine Services & Operations Manager		
RM22.4	Information	4. Implement document management system for all correspondence and company information.	EIL	A	Corporate Service Mgr		
RM22.5	Information	5. Implement system to manage personal information.	EIL	A	CEO		Include with RM3.2
RM22.6	Information	6. Develop information security polices to include prevent hacking, viruses etc.	EIL	A	GM Network Operations (asset & Plan Mgr)		
RM22.7	Information	7. Develop processes to back up information to prevent loss.	EIL	A	GM Network Operations (asset & Plan Mgr)		
RM22.8	Information	8. Develop disaster recovery plans for information systems.	EIL	A	GM Network Operations (asset & Plan Mgr)		
RM23.1	Technological	1. Include with any preliminary analysis (of a new initiative) a robust and rigorous risk assessment of the new initiative and how it fits into the existing business operations and its objectives.	EIL	C (Ongoing)	Business Development Manager		Process documented and Board included in the development of business cases and aware of level of risk assessment undertaken
RM24.1	Business Resilience	1. Develop Business Continuity Plans for EI.	EIL, ENL, EPL	A	CEO		
RM24.2	Business Resilience	2. Develop Crisis Management Plans for EI.	EIL, ENL, EPL	A	CEO		
RM24.3	Business Resilience	3. Initiate and implement Disaster Recovery Plans for EI.	EIL, ENL, EPL	A	CEO		

RM24.4	Business Resilience	4. Review the change management process within EIL.	EIL, ENL, EPL	C	CEO
--------	---------------------	---	---------------	---	-----

Legislative Identification & Analysis Report August 2004 (Legislative)

2.1.4.1	Legal Statutory Rights & Breach	1. Develop a Privacy policy	EIL	A	CEO
2.1.4.2	Legal Statutory Rights & Breach	2. Revise existing HR policies to improve understanding within organisation i.e.: Bill of Rights, Human Rights, Protected Disclosures	EIL	A	CEO,PA
2.2.4.1	Health & Safety	1. Confirm the smoke free policy to all staff	EIL	C	CEO,PA
2.2.4.2	Health & Safety	2. Review & update EIL health and safety programme including stress, fatigue policies and public safety.	EIL	A	CEO,PA
2.2.4.3	Health & Safety	3. Develop an alcohol policy	EIL	C	CEO,PA
2.2.4.4	Health & Safety	4. Review public safety through restricted access, signage and education processes with regard to port facilities	EIL, ENL, EPL	A	Corporate Service Mgr
2.3.4.1	Business Information	1. Develop an internet use policy	EIL	C	Asset & Planning Mgr
2.3.4.2	Business Information	2. Review information that is private (i.e.: related to the Privacy Act). Provide training on what is deemed personnel information	EIL	B	Asset & Planning Mgr
2.3.4.3	Business Information	3. Develop business information policies and procedures	EIL	B	Commercial and Regulatory Manager
2.3.4.4	Business Information	4. Develop information security policies to minimise the potential for hacking, viruses etc.	EIL	A	Asset & Planning Mgr
2.3.4.5	Business Information	5. Develop processes to back up electronic information	EIL, ENL, EPL	A	Asset & Planning Mgr
2.3.4.6	Business Information	6. Develop disaster recovery plans for information systems	EIL	A	Asset & Planning Mgr
2.3.4.7	Business Information	7. Develop policies on use of close circuit TV (CCTV)	EIL, EPL	C	Marine Services & Operations Manager
2.4.4.1	Tax	1. Check that backup staff are familiar with and regularly involved in tax processing	EIL	C	Corporate Service Mgr
2.5.4.1	Property - Buildings	1. Develop evacuation schemes for all owned/occupied buildings in ENL and EPL	EIL	A	Corporate Service Mgr
2.5.4.2	Property - Buildings	2. Develop a building maintenance regime for all buildings owned by ENL and EPL	EIL, ENL, EPL	B	Corporate Service Mgr
2.5.4.3	Property - Buildings	3. Develop compliance schedules for all buildings that fall under the 'existing use rights' of the Building Act 1991	EIL, ENL, EPL	B	Commercial and Regulatory Manager
2.7.4.1	Environmental	1. Develop procedures to comply with environmental legislation when working on Port (HSNO)	EIL	B	Marine Services & Operations Manager
2.7.4.2	Environmental	2. Maintain a register of all land use rights and obligations. This would include acceptable noise and emission limits	EIL	B	Corporate Service Mgr
2.7.4.3	Environmental	3. Prepare a register of sites which may be contaminated	EIL	B	Corporate Service Mgr
2.8.4.1	Contracts	1. Identify and check that all contracts are in writing and in compliance with the relevant legislation.	EIL	B	Commercial and Regulatory Manager

2.8.4.2	Contracts	2. Provide training to staff in related legislation	EIL	C	Commercial and Regulatory Manager
2.9.4.1	Sales and Marketing	1. Provide training on the various legislative obligations	EIL	C	Commercial and Regulatory Manager
2.10.4.1	Company Formation & Corporate Governance	1. Develop a legislative compliance document to provide assessment of compliance with relevant company legislation for each EIL business group.	EIL	B	Commercial and Regulatory Manager
2.11.4.1	Business Resilience	1. Develop a Business Resilience plan that is in compliance with the civil defence and emergency management Act 2002	EIL	A	Corporate Service Mgr
2.12.4.1	Road Vehicles	1. Incorporate the management of vehicles used on company business into the health and safety system.	EIL	B	Corporate Service Mgr
2.12.4.2	Road Vehicles	2. Ensure procedures exist to regularly check maintenance and roadworthiness of vehicles used on company business.	EIL, ENL	B	Corporate Service Mgr
2.13.4.1	Legal Statutory Rights & Breach	1. Develop a legislative compliance document for electricity related legislation	EIL, ENL	B	GM Network Operations

EIL Health & Safety Identification & Analysis Report November 2004 (EIP H&S REVIEW)

2.5.2.3	Coverage of the HSE Act 1992 Extended	1. Review definitions of the work place to include vehicles used on company business	EIL	B	Commercial and Regulatory Manager	1. Source and review current documentation. 2. Write procedure wrt legislation & ENL policies
2.5.2.3	Coverage of the HSE Act 1992 Extended	2. Include in identification and management of hazards, any issues related to vehicles and work related travel	EIL	B	Corporate Service Mgr	1. Source and review current documentation. 2. Write procedure wrt legislation & ENL policies
2.5.2.3	Coverage of the HSE Act 1992 Extended	3. Review the port and shipping services from a health and safety perspective	EPL	A	Marine Services & Operations Manager	1. Report to be completed by RHS. 2. Once complete, list and work through actions
2.5.2.3	Coverage of the HSE Act 1992 Extended	4. Review systems for managing volunteers, people on job training or in work experience and any loaned employees	EIL	C	CEO,PA	1. Source and review current documentation. 2. Write procedure wrt legislation & ENL policies & practicable suggestions
2.5.3.3	All Practicable Steps	1. Improve education and awareness of the term "all practicable steps" within all facets of the company, i.e.. field workers design and port operations as well as people working in offices	EIL	C	CEO,PA	1. Source and review current understanding & documentation. 2. Write procedure wrt ENL policies & practicable suggestions

2.3.4.2	Personnel Protection Clothing & Equipment	1. Review use and provision of all protective clothing and equipment and training in its use.;	EIL, ENL, EPL	A	GM Network Operations	1. Review current system with ENL/EPL. 2. Review and document wrt legislation/acts etc. 1. Source and review current documentation. 2. Write procedure wrt legislation & ENL policies
2.5.5.2	Employee Right to Information	1. Review all health and safety information making sure it is understandable and readily available to all employees	EIL, ENL, EPL	A	Commercial and Regulatory Manager	1. Source and review current documentation. 2. Write procedure wrt legislation & ENL policies
2.5.6.3	Hirers and Suppliers of Plant	1. When buying or hiring plant, provide all necessary information to the supplier regarding the plants intended use, it is fit for use and training is provided to operators.	EIL, ENL, EPL	B	Commercial and Regulatory Manager	1. Source and review current documentation. 2. Write procedure wrt legislation & ENL policies
2.5.6.3	Hirers and Suppliers of Plant	3. Review all port lease arrangements against the requirements in the Act	EPL	B	Marine Services & Operations Manager	Include in procedure as per all of 6.4 1. Source and review current documentation 2. Define this in terms of EIL as a business then filter specifically down to EPL & ENL
2.5.7.2	Hazardous Behavior	1. Develop hazard identification processes for behavioral events that may exist or arise in the work environment 2. Have procedures for employees to report fatigue or other hazardous behavior on a "no blame" basis	EIL, ENL, EPL	A	Commercial and Regulatory Manager	Source template for this 1. Source template for this 2. Write procedure wrt legislation & ENL policies 3. Source workshop Include in procedure as per all of 7.3
2.5.7.2	Hazardous Behavior	4. Provide training for staff in the areas of wellness, balancing work and non-work activities, and in the areas of stress and fatigue 6. Develop guidelines for managing the potential behavioral affects of overtime, callouts, and extended working hours	EIL, ENL, EPL	B	CEO,PA	1. Source template for this 2. Write procedure wrt legislation & ENL policies 3. Source workshop Include in procedure as per all of 7.3
2.5.7.2	Hazardous Behavior	6. Develop guidelines for managing the potential behavioral affects of overtime, callouts, and extended working hours	EIL, ENL, EPL	B	CEO,PA	1. Source template for this 2. Write procedure wrt legislation & ENL policies 3. Source workshop Include in procedure as per all of 7.3
2.5.8.2	Stress as a Harm	1. Develop procedures for identifying sources of harmful work related stress, i.e.. long hours, peak or exceptional workload, redundancy and restructuring	Eil	B	CEO,PA	1. Source template for this 2. Write procedure wrt legislation & ENL policies 3. Source workshop Include in procedure as per all of 8.2
2.5.8.2	Stress as a Harm	2. Develop procedures for reporting and managing stress 1. Review contracts with self-employed contractors to ensure they understand their obligations to notify the principal of any accidents (or near misses) that may occur when working on an Eastland controlled site. Also the requirement to notify OSH if any serious harm incident has occurred.	EIL	B	CEO,PA	1. Source template for this 2. Write procedure wrt legislation & ENL policies 3. Source workshop Include in procedure as per all of 8.2
2.5.9.3	Accident Recording and Reporting	Also the requirement to notify OSH if any serious harm incident has occurred.	EIL, ENL, EPL	C	Commercial and Regulatory Manager	Review EIL process & standards and then discuss to contractors Review what is there and work with contractors to review their processes and documentation
2.5.9.3	Accident Recording and Reporting	2. Enlarge the Eastland accident register to include all accidents that occurred on Eastland worksites	EIL, ENL, EPL	B	CEO,PA	Review EIL process & standards and then discuss to contractors Review what is there and work with contractors to review their processes and documentation

							against that of the EIL standard and process. Offer assistance where necessary and wanted.
2.5.10.2	Employee's Right to Refuse Work	1. Develop processes to identify situations where the work becomes significantly hazardous	EIL, ENL, EPL	B	CEO,PA		1. Review the current accident register for all the business 2.create a generic one that can encompass that of the EPL, ENL and other
2.5.10.2	Employee's Right to Refuse Work	2. Train staff and management of the right to refuse work if it could result in serious harm	EIL, ENL, EPL	B	CEO,PA		1. Define specific process within the Hazard identification process 2. Ensure fit within EIL/EPL/ENL & training.
2.5.11.2	Employee Participation	1. Review the employee participation system to ensure compliance with the intent of the Act and gain ratification from staff on the preferred system	ENL, EPL	A	CEO,PA		1. Source and review current documentation. 2. Write procedure wrt legislation & ENL policies. 3. Train
2.5.13.2	Hazard Notices	1. If health and safety representatives are included on Eastland's employee system then: Provide training to management and staff on the application hazard notices	EIL	A	CEO,PA		1. Review as per above 2. Include within documentation 3. Train
2.5.14.3	Enforcement	1. Review the role of MSA in EPL port and marine services operations	EPL	B	Marine Services & Operations Manager		1. Review MSA Legislation against that of EPL services
2.5.15.2	Infringement Notices	2. Develop training for managers and staff to actively engage and work with OSH inspectors	EIL, ENL, EPL	C	Commercial and Regulatory Manager		Include in steps as per 15.2
2.5.15.2	Infringement Notices	3. Provide training to staff and managers on the various enforcement tools	EIL, ENL, EPL	C	Commercial and Regulatory Manager		Include in steps as per 15.2
2.5.16.2	Prosecutions	1. Inform staff of the level of penalties that could be applied following prosecution under the Act	EIL, ENL, EPL	B	Commercial and Regulatory Manager		1. Review Act/Legislation & obligations 2.Include in documentation 3. Present
2.5.18.2	Insurance	1. Review all insurances to check that they remain lawful and ensure they cover legal costs and reparations	EIL, ENL, EPL	B	Corporate Service Mgr		

Insurance Review Report for ENL February 2005 (Insurance)

3.4.1.0	Financial - Insurance	1. Review ENL decision to insure the Contract Works, Extended Works and Materials	ENL	C	GM Network Operations		Works Contract
3.4.2.0	Legal - Contractual	2. Have an insurance expert review the conditions of contract to ensure consistency across the condition of contract in particular the possible conflict between clauses 8.3.1 and 8.5.1	EIL	B	Corporate Service Mgr		Works Contract

3.4.3.0	Legal - Contractual	3. Revise the condition of contracts to require the contractor to be responsible for any loss below the deductible (contract works insurance) IE: the first \$20,000 of each and every claim.	EIL, ENL	A	Commercial and Regulatory Manager	Works Contract
3.4.4.0	Legal - Contractual	4. Develop a system whereby all new contractors, prior to commencing work with ENL, submit confirmation that they have the acceptable insurances and that the insurers accept ENL requirements. This step could form part of their pre-qualification process.	ENL	A	GM Network Operations	Works Contract
3.4.5.0	Legal - Contractual	5. Develop a management system where all incumbent contractors on a regular basis (at least annually) submit an Insurance Certificate signed by the insurers confirming that the policies are in place and meet the requirements of the contract conditions. Proforma schedules are available to assist in the verification.	ENL	B	GM Network Operations	Works Contract
3.4.6.0	Legal - Contractual	6. Request the contractor confirm that they have the required motor vehicle and plant insurances as specified in the contract conditions for the current term of the contract.	ENL	C	GM Network Operations	Works Contract
4.4.1.0	Legal - Contractual	1. Develop a set of simple conditions for minor works order type contracts. These would specify ENL insurance requirements both the maximum insurance levels and deductibles ie: where the contractor is responsible for the first \$20K for jobs greater than \$20,000 and \$5,000 for all other jobs.	ENL	B	GM Network Operations	Minor Works Contractors and Subcontractors
4.4.2.0	Legal - Contractual	2. Develop a system whereby all new contractors prior to commencing work with ENL submit confirmation they have the acceptable insurances and that the insurers accept ENL requirements. This step could be form part of their pre-qualification process	ENL	B	GM Network Operations	Minor Works Contractors and Subcontractors
4.4.3.0	Legal - Contractual	3. Develop a management system where all incumbent contractors on a regular basis (at least annually) submit an Insurance Certificate signed by the insurers confirming that the policies are in place and meet the requirements of the contract conditions. Proforma schedules are available to assist in the verification.	ENL	C	GM Network Operations	Minor Works Contractors and Subcontractors
4.4.4.0	Legal - Contractual	4. Request the contractors confirm that they have current motor vehicles and plant insurances.	ENL	C	GM Network Operations	Minor Works Contractors and Subcontractors
5.4.1.0	Legal - Contractual	1. Develop a service level agreement with the wholesalers.	ENL	B	GM Network Operations	Supplier of Goods
5.4.2.0	Legal - Contractual	2. Request that the wholesalers confirm what other insurances they have in place for the current year i.e.: motor vehicle and plant insurances.	ENL	C	GM Network Operations	Supplier of Goods
6.4.1.0	Legal - Contractual	1. Develop a service level agreement with design consultants	EIL, ENL	B	Commercial and Regulatory Manager	Design Consultants
6.4.2.0	Legal - Contractual	2. Request the consultants confirm what other insurances they have in place for the current year i.e.: motor vehicle third party.	EIL	C	Commercial and Regulatory Manager	Design Consultants
7.4.1.0	Legal - Contractual	1. Develop a service level agreement with these arboriculture contractors	ENL	C	Corporate Service Mgr	Arboriculture Contractors
7.4.2.0	Legal - Contractual	2. Request the arboriculture contractors confirm what other insurances they have in place for the current year i.e.: motor vehicle and plant insurances.	ENL	C	Corporate Service Mgr	Arboriculture Contractors
8.4.1.0	Legal - Contractual	1. Have an insurance expert provide guidance on what minimum coverage ENL should expect from helicopter operators.	EIL	B	Corporate Service Mgr	Helicopter Operators
8.4.2.0	Legal - Contractual	2. Develop with these operators a service level agreement which specifies the insurance	EIL, ENL	B	Commercial and Regulatory Manager	Helicopter Operators

requirements.

9.2.1.0	Legal - Contractual	1. Ensure that all major contracts for supply of goods require the supplier to be responsible for care and insurance of goods until unloading and hand over to ENL	ENL	B	Commercial and Regulatory Manager	Major Supply Contracts
---------	------------------------	--	-----	---	--------------------------------------	---------------------------

6.2 Identifying specific risks

The risk management process as it applies to ENL's electricity network business is intended to assess exposure and prioritise mitigating actions. The process is as follows...

- Risk issues are identified and recorded.
- Minor risk issues are eliminated or controlled.
- Potential solutions/actions are developed.
- Actions are assessed against outcomes or success factors.
- Actions are ranked on the basis of weighted performance against outcomes.
- Results are then applied to cost benefit analysis in project viability tests.

This approach overcomes difficulties in trying to quantify risk via assessment of frequency, severity and impact.

6.2.1 Guiding principles

ENL's behavior and decision making is guided by the following principles...

- EIL endeavors at all times to purchase and provide secure risk managed products and services at the least cost and at the same time if possible secure long term contracts for purchases, services and sales.
- Only authorised contractors and personnel may transact business in EIL's name and specified limits shall be maintained for such authorisations.
- ENL will only purchase or sell product or services in line with its business expertise.
- ENL will only undertake transactions with approved contractors and suppliers. Such transactions shall be maintained within specified limits.

- ENL's risk management policy and related procedures and systems are to be reviewed 2 yearly by an independent party.
- Annual internal reviews of risk management documentation are undertaken to ensure risks have been assessed correctly and that actions to reduce risks are actually taken.

6.2.2 Risk Categories

ENL uses the following tactics to manage risk under the following broad categories...

Commercial risks

- Competition - assessments of ENL's exposure to bypass or generation are undertaken annually as part of ENL's strategic planning process. As issues arise they are discussed at monthly board meetings.
- Customer activity – regular communication is maintained with all ENL's significant consumers. In addition to growth projects ENL has policies in place to provide assistance to local businesses.
- Project management & professional liability - regular training and refreshers are carried out. Insurance policies and registrations with professional bodies are kept up to date. Contracts with service providers define provisions required to control associated risks. Maintenance and inspection activities documented in this plan, in addition to condition assessment information target identification of hazards and non-compliance issues. Targets for elimination of the risks associated with the hazards and compliance issues are also documented for each asset category in section 8 of this plan.
- Financial - contracts with ENL consumers define liability and performance penalties. Contracts with ENL suppliers include requirements for insurance and protection of works.

Legal, statutory & regulatory risks

- Financial security - quality system procedures for financial authorities and identification of ENL's representatives are in place and are externally reviewed.
- Confidentially- policies and quality system procedures are in place to control access to and dissemination of confidential data.

- Legal compliance & statutory liability - quality system procedures and 6 monthly check lists are used to ensure all obligations are met on time and to ensure issues are identified and resolved. Issues are reviewed at 6 monthly board meetings and external parties are used for procedural reviews.
- Health & safety - quality system policies, procedures and 6 monthly refresher training are in place. These procedures include hazard identification & control, contractor authorisation, incident reporting and standards for conduct. Self-auditing and independent auditing requirements are included in contractual arrangements and network authorisations.

Information security and control risks

- Documentation – quality system procedures are in place for storage and duplication of critical documentation. A majority of the critical documentation is backed up via the computer systems used to generate the documents. Risk of total loss is controlled by use of multiple storage locations throughout the region.
- Information systems – IT procedures are in place to provide 100% redundancy and backup for all systems used. Spares are maintained for critical equipment items. Testing of procedures and auditing of their effectiveness is undertaken on a regular basis.
- Communications – alternative communications systems are maintained. Use of external service providers is duplicated by ENL's own communications network.
- ENL maintains the ability to relay business communications via third parties based outside of the Gisborne and Wairoa regions.

Physical security of resources

- Physical security – Physical security provisions are maintained at all strategic sites through long-term contracts with security providers. Security systems are tested annually.
- Land use – legal agreements and easements are maintained for all sites considered strategic or where land use or access is vulnerable to dispute.

Electricity supply risks

- Loss of bulk supply - Transpower does not include (n-1) security within contractual arrangements at Massey Rd and Wairoa GXP's. Hence there is no ability to negotiate cost penalties for loss of supply as was experienced in 2001 and 2003. The purchase of six 1MWe diesel generators in 2003, when

combined with the Waihi hydro scheme gives us some measure of security for up to 20% of ENL's maximum demand.

- Liability for loss of supply or fluctuations - contractual arrangements and insurance policies are in place to limit ENL's exposure to the associated outcomes.
- Revenue Protection- Procedures are in place to work with Energy retailers where necessary to continually monitor identify and eliminate issues.

Electricity outage risks

- Breakdown and Equipment failure - network design and material standards are used to control the quality and suitability of product used. Procedures for documentation of asset & equipment failure are in place. Suitability of new product and product use is the responsibility of the Asset Manager and is under continual review. Asset based solutions and standards detailed specifically for each asset. Strategic spares of critical items with long delivery times are held by us including 50kV/11kV transformers, 50kV switchgear & line hardware, protection, SCADA and communications equipment. Equipment that can be relocated to cover failure of strategic items has also been identified which generally includes 50/11kV transformers, and down stream 11kV switchgear and protection equipment that can be used to replace failure of primary feeder circuit breakers and protection.
- Supply restoration - contracts provide for minimum re-sourcing, backup re-sourcing, and response practices. Response Plans include pre-prepared switching and contingency plans for all sub-transmission and critical equipment. Product suppliers are monitored and audited to ensure specified minimum levels of product spares and replacements are maintained in the region. Procedures and documentation are maintained to ensure product can be sourced from outside the region in a timely manner to cater for catastrophic events. Re-locatable diesel generation is available as a substitute for normal distribution supply. Procedures are in place for review of outages to identify issues where security standards are not maintained in terms of redundant capacity, alternative supply options and restoration times. Corrective actions are incorporated into contractual arrangements design standards and asset management plans as appropriate to control the risks.
- Access to specialised equipment - procedures and arrangements to ensure 24 hour access to specialised equipment are maintained and verified on an annual basis.
- Competency and capabilities in helicopter transportation and line reconstruction techniques are maintained to ensure risks associated with road

access are controlled via alternative means. This is particularly important in remote areas of the region.

6.3 Planned responses

ENL's key responses are described below...

6.3.1 Continuity plans

ENL maintains an Emergency Preparedness Plan which provides procedures and contact lists for explosion, fire, disease, accident, injury or death incidents, and environmental accidents that may be associated with operation of ENL's main office facilities, network assets and incidents involving contractors working for the company.

6.3.2 Disaster recovery

Policies, plans and readily accessible documentation are maintained to maximise the effectiveness of ENL's efforts to overcome disaster events. Financial arrangements and insurance policies are in place to control the associated financial impacts resulting from events of this nature. The network is not covered by catastrophe insurance. Annual budgeting includes a contingency sum for storm and large unplanned events also a borrowing provision is allocated in the annual funding plan.

Events considered in the assessments include flooding, earthquake, tsunami, war, landslips, drought, volcanic eruption, severe storms and bush fire.

ENL is involved in and supports civil defence preparedness through the involvement with the Hawkes Bay Regional Council and the Gisborne District Council LifeLines groups.

6.3.3 Electricity Supply

Loss of Bulk supply- Transpower does not include N-1 level security within contractual arrangements at the Gisborne and Wairoa Grid exit points. Hence there is no ability to negotiate cost penalties for loss of supply as was experienced in 2001/2002 and 2003. The purchase of six 1MW diesel generators in 2003, when combined with the Waihi hydro scheme has provided ENL with demand Generation capability up to 20% of the maximum demand.

Liability for loss of supply or fluctuations- Contractual arrangements and insurance policies are in place to control the associated outcomes.

Revenue Protection- Procedures are in place to work with Energy retailers where necessary to continually monitor identify and eliminate issues.

Grid Emergency- Procedures are in place so that ENL is able to meet its obligations under the Electricity Governance Rules.

6.3.4 Electricity Outages

Breakdown and Equipment failure

Network Design and material standards are used to control the quality and suitability of product used. Procedures for documentation of asset or equipment failure are in place. Suitability of new product and product used is the responsibility of the Asset Manager and is under continual review. Significant risks identified are included for each asset category in section 8 of this plan. Asset based solutions and standards detailed specifically for each asset. Strategic spares of critical items with long delivery times are held by ENL including 50kV/11kV transformers 50kV switchgear/line hardware, Protection/SCADA and communications equipment. Equipment that can be relocated to cover failure of strategic items has also been identified. Generally this includes 50/11kV transformers, and down stream 11kV switchgear and protection equipment that can be used to replace failure of primary feeder circuit breakers and protection.

Supply restoration

Contracts provide for minimum re-sourcing, backup re-sourcing, and response practices. Response Plans include pre-prepared switching and contingency plans for all sub-transmission and critical equipment. Product suppliers are monitored and audited to ensure specified minimum levels of product spares and replacements are maintained in the region. Procedures and documentation are maintained to ensure product can be sourced from outside the region in a timely manner to cater for catastrophic events. Re-locatable diesel generation is available as a substitute for normal distribution supply. Procedures are in place for review of outages to identify issues where security standards are not maintained in terms of redundant capacity, alternative supply options and restoration times. Corrective actions are incorporated into contractual arrangements design standards and asset management plans as appropriate to control the risks.

Access and specialised equipment issues

Procedures and arrangements to ensure 24 hour access to specialised equipment are maintained and verified on an annual basis.

Competency and capabilities in Helicopter transportation and line reconstruction techniques are maintained to ensure risks associated with road access are controlled via alternative means. This is particularly important in remote areas of the region.

6.3.5 Asset Management Assessment

The results for identified risk issues directly relating to asset management risk assessments and action plan priorities are presented in the following matrix covering specific risk issues,

For each asset management risk currently identified:

The success factors applied are as follows...

- The weightings applied
- The assessment scores
- The resulting priorities

In general there is a strong correlation between risk priorities and current work program's. However it should be noted that risk is not the sole driver of work priorities. Risk priorities influence development plans but timings are also based on the need to co-ordinate projects.

The identified risks are addressed within the current work programs given in the Asset Management Plan. However annual review is necessary due to the rate of change in the network. This process captures new risks and adjusts priorities.

Action Plan Priorities Ranked by Risk Reduction Outcomes

Success Factor or Outcomes :

Reduced combined effect with other risks or increased combined provision

Improved Safety

Reduced SAIDI (improved service)

Reduced SAIFI (improved reliability)

Cost reduced

Return on investment required achieved or increased

Economic Impact to Community Reduced

Compliance and Environmental Responsibility

Public Acceptance

Meets Urgent Need

Ranking Criteria (against each Success Factor) : 1 to 10

0: No Impact 2: Low Impact 5: Medium Impact 7: High Impact 10: Crucial

Priority	Action Project Number and Title	Criteria Weightings										Score 1000
		20	10	5	10	10	5	10	15	5	10	
1	31 Red tagged pole replacement high density	10	10	10	6	7	8	9	8	10	8	860.00
2	55 Carnarvon St Security	10	10	10	8	6	5	8	10	0	7	815.00
4	32 Red tagged pole replacement rural	8	9	10	4	7	8	9	7	9	8	770.00
5	54 50kV line from Carnarvon St to Kaiti	10	10	8	5	6	4	6	10	0	6	740.00
7	57 Parkinson St Security	8	10	8	9	6	4	6	9	0	6	725.00
11	58 50kV line Parkinson Matawhero JNL	8	8	8	9	6	3	4	9	0	6	680.00
12	33 Red tagged pole replacement remote	6	8	10	2	5	9	9	6	8	8	665.00
13	39 Quadrant ABS replacement	7	2	10	3	1	8	9	10	10	8	660.00
14	38 Single Phase line conversion 300kM	5	7	0	9	8	9	7	8	0	7	645.00
16	30 Correct Low voltage Raupunga feeder Wairoa	9	10	10	4	4	3	8	4	0	4	605.00
18	24 33kV line extension Blacks Pad to Mahia	6	10	4	4	4	2	8	8	0	5	580.00
19	77 Raupunga/Frasertown Tie Capacity	8	8	0	5	4	3	5	9	0	3	560.00
21	35 Switchgear Automation	6	5	0	5	3	8	4	9	2	6	535.00
22	5 Customer RISK Provisions	6	3	0	8	10	0	4	8	0	4	530.00
23	76 Kiwi Substation Zone Wairoa CBD Security	4	10	6	7	4	4	3	8	0	4	530.00
26	1 Relax Voltage Standards for Tx Capacity	9	3	7	7	10	5	0	0	0	4	480.00
28	8 Neutral Earthing Resistors	10	7	10	2	1	6	0	0	10	3	460.00
34	74 Lowe St CBD Security	6	10	0	6	2	2	2	6	0	1	430.00
35	79 Tuai Supply	8	7	0	2	1	4	2	7	0	2	425.00
36	21 Matawai Supply security from Ngatapa	4	6	0	2	4	3	7	7	0	3	420.00
37	34 Correct Low road clearances	6	6	10	1	1	2	5	3	6	3	415.00
38	6 OLTC 110/50kV Transformers	8	3	8	7	5	4	0	0	0	4	410.00
40	2 Improve Load control capability	7	3	3	6	7	6	0	0	0	6	405.00
41	7 Install load peaking plant	2	4	3	7	4	8	0	6	0	7	405.00
45	60 Puha Security	6	7	0	3	2	2	0	8	0	2	390.00
47	3 Improved Power Factor Correction	6	3	6	6	8	5	0	0	0	3	375.00
51	42 Magnefix replacement (Fires)	5	0	2	2	1	7	2	7	8	2	360.00
52	4 Reduce Network Distribution Losses	4	3	5	4	8	7	0	0	0	6	350.00
53	47 LV conductor upgrades	5	5	8	2	6	4	0	0	0	4	330.00
54	48 Service Lines Capacity/Insulation	5	4	8	1	5	5	0	0	8	2	325.00
56	26 Tuai Voltage Correction	8	7	4	1	2	1	0	2	0	0	315.00
58	11 Aggregate GXP's Gisborne and Wairoa	6	4	0	3	6	8	0	0	0	1	300.00
59	44 Pillar Box Dammage	4	6	10	0	0	4	0	0	8	3	280.00
60	66 JNL Security	8	5	0	3	0	0	1	2	0	0	280.00
61	65 Cedenco Security	8	4	0	2	0	0	1	2	0	0	260.00
62	71 Montana Security	8	4	0	2	0	0	1	2	0	0	260.00
64	25 Kaiti Tolaga Voltage Correction	4	7	4	1	4	1	0	2	0	0	255.00
65	46 Meter/pillar replacement	3	5	9	0	0	0	0	0	8	3	225.00
66	45 Exposed LV pannels	4	3	8	0	0	0	0	0	8	3	220.00
67	37 Tapped termination replacement	4	0	0	1	0	3	2	4	2	1	205.00
69	67 Hospital Security	4	7	0	1	0	0	1	2	0	0	200.00
70	68 Affco Wairoa Security	4	5	0	3	0	0	1	2	0	0	200.00
72	28 Enviroment oil contamination	2	5	10	1	0	2	0	0	1	1	175.00
76	43 Distribution Transformer Earths	2	2	7	0	0	0	0	0	6	2	145.00
78	27 Earth Mat Upgrades	2	3	8	0	0	0	0	0	6	0	140.00
79	72 Hershell Rd Feeder Security	1	3	0	1	0	0	1	4	0	1	140.00
80	73 Airport Security	1	6	0	1	0	0	1	1	0	0	115.00

7. Funding the business

7.1 ENL's business model

ENL's business model is based around the right-hand side of Figure 7.1(a) below.

Figure 7.1(a) – Customer interface model

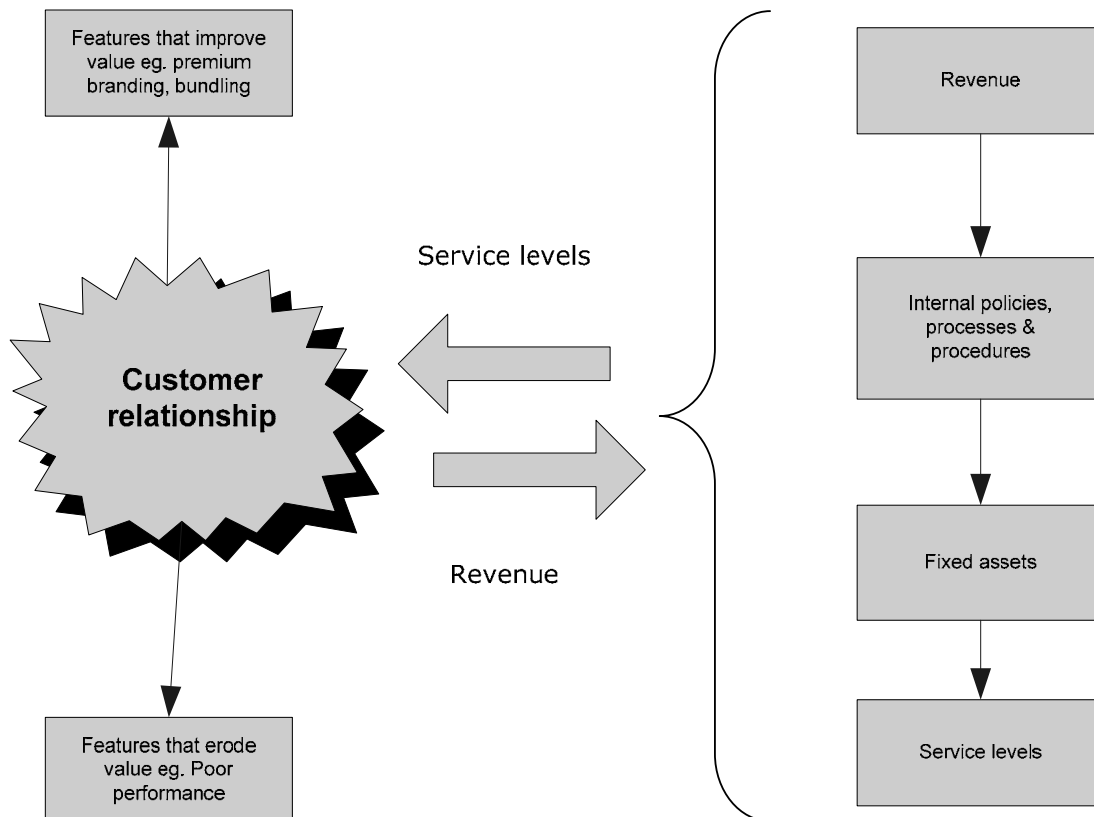

This model shows that ENL receives revenue from its consumers (via the energy retailers who operate on the network) and then, through a wide range of internal processes, policies and plans, ENL converts that cash into fixed assets. These fixed assets in turn create the service levels such as capacity, reliability and security that consumers and other stakeholders want.

7.2 Financial Income

ENL's income comes primarily from the energy retailers who pay for conveying energy over ENL's lines. Separately identified in ENL's invoicing of charges is the pass through transmission costs associated with ENL's connections to the Transpower Grid.

Energy retailers present a bundled charge which incorporates transmission, distribution and energy costs through to end user customers.

When determining the level and constituency of its charges, ENL considers the following pricing principles and influences;

Revenue Requirements

Pricing should obtain sufficient revenue for ENL to meet the following requirements;

- Meet its contractual obligations for connection to the Transpower Grid.
- Meet its contractual obligations for the delivery of energy over its network to the end-consumers.
- Comply with statutory requirements on public safety, environmental protection and quality of supply.
- Provide for new investment.
- Provide a commercially appropriate return on funds to the shareholder.

Efficiency

Pricing must be economically efficient in the investment signals it creates. This is achieved by matching the pricing structure to the cost structure as closely as practical.

Even-handedness

Pricing must be even-handed across different load groups. Specifically:

- The charges to various load groups using the network should vary according to their relative use of different assets.
- Where load groups have different service requirements, service at levels above the common denominator should be charged specifically to the load groups demanding higher levels of service.
- Average costing will be applied where there is common good usage of assets and services within a load group.
- Where new investment is required those users who obtain the benefit should be required to contribute towards the cost.

Pricing must also be even-handed in its treatment of different retailers and provide for equal access as a matter of statutory requirement.

Simplicity

Pricing must be kept as simple and as administratively efficient as practical. Specifically:

- Transmission charges should be separated from distribution charges.

- ENL should endeavor to ensure distribution costs are relatively stable over time.

Load Management and Embedded Generation

The pricing methodology should provide signals to encourage customer demand-side participation in load management and investment in embedded generation.

Regulation

Electricity lines companies are controlled by the requirements set out by the Commerce Commission in the Commerce Act (Electricity Distribution Thresholds) Notice 2004. This means that ENL is assessed annually against two thresholds:

- i. a price path threshold, representing the expected annual change in lines business average prices (through applying a CPI-X formula); and
- ii. a quality threshold, comprising a reliability criterion and a consumer communication criterion.

The price path threshold criteria limits lines companies on the annual change in their line charges by setting a threshold that can only change by a maximum of CPI-X per annum. Under the current price path compliance test a lines company is required to demonstrate that (This years prices) x (Last years quantities) is no greater than (Last years prices) x (Last years quantities) x (CPI-X Adjustment).

The X factor that ENL has been assigned is 2%, the harshest allocation given out by the Commerce Commission.

ENL has some concerns about the inequality of the CPI-X regime and the X factor it was allocated. From subsequent analysis undertaken, ENL believes that it was unfairly penalized because it had (and has);

- i) Low average connections (ICP's) per kilometer of line;
- ii) Low average consumption per ICP, and
- iii) A high percent of high voltage lines (it appears that an MVA/km proxy was used for asset value) which the model construed as meaning greater in-efficiency.
- iv) On an industry basis relatively high prices

ENL believes that none of the first three factors above are inside its reasonable control and given that ENL has low customer numbers and low consumption prices will be high in comparison to lines companies with large urban and industrial customer bases.

ENL has expressed its CPI-X concerns to the regulatory agencies concerned with a view to getting due consideration when X factors are reset in 2009.

The consequence of regulation is that although pricing is designed to reflect the cost of supply required to meet customers/stakeholders expectations, an adjustment to the final pricing must be made to ensure that ENL can afford to comply with the regulations and not breach the price path threshold.

7.3 Financial Projections

Financial projections are one of the key outputs of this AMP, representing the financial outcome of the management strategies and specific maintenance, renewal and development plans set out herein. They outline ENL's network expenditure over the planning period, separating capital and maintenance related expenditure.

Capital expenditure is defined as expenditure that results in increased value of an asset, where the value is defined by service potential (capacity) to derive future benefits, earnings or reduced costs. If extra expenditure, say from an alteration to the original asset, results in extra value after satisfying an independent test on commercial viability, then it is capital expenditure. Overhead to underground conversion, life extension and load driven capacity upgrades fit into this category.

Maintenance expenditure is defined as expenditure required to operate an asset or keep it in the minimum acceptable serviceable condition needed to continue its earning until the asset has satisfied the life and earning expectations used to establish the commercial viability of the original investment decision. Commercial viability tests will assume a certain level of operating and maintenance expense. Expenditure beyond this level may threaten commercial viability. Sensitivity to this and other risks are weighted into investment decisions.

7.3.1 Capital Expenditure

Total capital expenditure over the planning period, as described in Sections 4.0 and 5.0, is \$50.185 m. The expenditure profile is relatively flat with an average expenditure of approximately \$5.0 m pa, indicating steady state assumptions apply. This level of capital expenditure equates to approximately 5.8% ODV which based on the 2005 Information Disclosure statistics is in line with the industry average of 6.2%.

Capital expenditure forecasts for the planning period are provided by asset type and expenditure "driver". Comments on the categories of expenditure "driver" are made below.

Condition and Compliance

Condition and compliance driven capital expenditure for the planning period averages \$3.5m pa., and is \$36.58m in total. It equates to 70% of the total capital expenditure forecast for the period. Condition and Compliance expenditure is fully funded by depreciation.

This category of expenditure applies to the replacement and renewal of assets, as described in Section 5.4, where physical, operational or safety performance has deteriorated primarily due to age. The timely renewal of deteriorated assets is a primary influence on the ability to achieve network performance targets.

As identified in Section 5.4 a “gap” is forecast between the level of renewal investment required to address 11kV conductor and pole condition driven replacement and the level of investment achievable under current regulatory revenue constraints. For the planning period the shortfall in renewal investment is approximately \$1.0m pa.

In the long term the shortfall in renewal investment versus required renewal rates will result in the average age of the network increasing and a backlog of asset renewal occurring. The consequences of this are that ENL may not be able to achieve levels of operational performance required by regulation or expected by customers.

Growth and Security

Growth and security driven capital expenditure for the planning period is \$9.99m and is 20% of the total capital expenditure forecast for the period.

This category of expenditure includes provision for the steady state customer driven network extension and capacity upgrades that cannot be avoided. The only major projects included are those where the upgrade triggers are currently exceeded. Trigger levels for growth upgrades predicted are described in Section 5.5.

A key feature of these projections is that while the AMP attempts to predict the impact of growth on network development, probable timings, etc. these issues are excluded from financial planning until more certainty on size and location and optimum response is evident.

Performance and Development

Performance and new development driven capital expenditure for the planning period is \$5.35m and equates to 10% of the total capital expenditure forecast for the period.

A significant portion of this expenditure is forecast to occur in the first 4 years of the planning period and as described in Section 4.0 is associated with the development of the 33kV Sub transmission, the installation of additional capacity to meet demand and performance enhancement through rural automation and load control upgrade

The following tables and graphs present the forecast expenditure as per the categorisation above, in summary by asset type and in full.

Summary by Asset Group	2006/07	2007/08	2008/09	2009/10	2010/11	2011/12	2012/13	2013/14	2014/15	2015/16	Total
Total	\$6,917,790	\$5,310,200	\$5,274,000	\$5,182,500	\$4,674,500	\$4,529,500	\$4,516,700	\$4,732,200	\$4,763,250	\$4,284,500	\$50,185,140
Generation Peaking Plants	\$0	\$0	\$0	\$0	\$0	\$0	\$0	\$0	\$0	\$0	\$0
50 kV Lines	\$1,830,000	\$300,000	\$300,000	\$300,000	\$300,000	\$300,000	\$300,000	\$300,000	\$300,000	\$300,000	\$4,530,000
11kV Lines and Cables	\$2,706,000	\$2,470,200	\$2,202,000	\$2,238,000	\$2,245,000	\$2,560,000	\$2,397,200	\$2,427,700	\$2,428,750	\$2,350,000	\$24,024,850
LT Lines and Cables	\$450,000	\$450,000	\$450,000	\$450,000	\$450,000	\$450,000	\$450,000	\$450,000	\$450,000	\$450,000	\$4,500,000
Service Connections	\$70,000	\$70,000	\$70,000	\$70,000	\$70,000	\$20,000	\$20,000	\$20,000	\$20,000	\$20,000	\$450,000
Load Control	\$350,000	\$250,000	\$350,000	\$350,000	\$250,000	\$0	\$0	\$0	\$0	\$0	\$1,550,000
Zone Substations	\$150,000	\$570,000	\$520,000	\$520,000	\$10,000	\$10,000	\$260,000	\$460,000	\$410,000	\$10,000	\$2,920,000
50kV CB's	\$0	\$0	\$160,000	\$160,000	\$260,000	\$0	\$0	\$0	\$80,000	\$80,000	\$740,000
11kV CB's Rural	\$205,290	\$0	\$0	\$0	\$0	\$0	\$0	\$0	\$0	\$0	\$205,290
Distribution Transformers	\$577,000	\$577,000	\$577,000	\$577,000	\$577,000	\$577,000	\$577,000	\$577,000	\$577,000	\$577,000	\$5,770,000
Pole Mounted Isolation Equipment	\$127,000	\$127,000	\$127,000	\$64,500	\$64,500	\$64,500	\$64,500	\$64,500	\$64,500	\$64,500	\$832,500
11kV Ground Mounted Switchgear	\$183,500	\$131,000	\$131,000	\$131,000	\$131,000	\$231,000	\$131,000	\$131,000	\$231,000	\$231,000	\$1,662,500
LV Switchgear	\$80,000	\$80,000	\$80,000	\$40,000	\$40,000	\$40,000	\$40,000	\$40,000	\$40,000	\$40,000	\$520,000
Control and Protection	\$63,000	\$125,000	\$115,000	\$120,000	\$25,000	\$25,000	\$25,000	\$130,000	\$30,000	\$30,000	\$688,000
Communications	\$104,000	\$80,000	\$80,000	\$80,000	\$80,000	\$80,000	\$80,000	\$80,000	\$80,000	\$80,000	\$824,000
SCADA	\$22,000	\$80,000	\$112,000	\$82,000	\$172,000	\$172,000	\$172,000	\$52,000	\$52,000	\$52,000	\$968,000

Summary by Catagory	2006/07	2007/08	2008/09	2009/10	2010/11	2011/12	2012/13	2013/14	2014/15	2015/16	
Performance/Development	2,355,290	818,000	420,000	420,000	290,000	40,000	40,000	490,000	440,000	40,000	\$5,353,290
Growth/Security	1,535,000	1,389,200	1,071,000	807,000	814,000	1,129,000	966,200	786,700	787,750	709,000	\$9,994,850
Condition/Compliance	3,027,500	3,103,000	3,783,000	3,955,500	3,570,500	3,360,500	3,510,500	3,455,500	3,535,500	3,535,500	\$34,837,000

Capital Expenditure Projections

Description	Year	2006/07	2007/08	2008/09	2009/10	2010/11	2011/12	2012/13	2013/14	2014/15	2015/16
Total		6,917,790	5,310,200	5,274,000	5,182,500	4,674,500	4,529,500	4,516,700	4,732,200	4,763,250	4,284,500
Generation Peaking Plants	Category	0	0	0	0	0	0	0	0		
50 kV Lines		1,830,000	300,000	300,000	300,000	300,000	300,000	300,000	300,000	300,000	300,000
Age replacement 40 poles per Year	Condition										
	Compliance	200,000	200,000	200,000	200,000	200,000	200,000	200,000	200,000	200,000	200,000
NZED 2nd hand Insulator replacement	Condition										
	Compliance	30,000	30,000	30,000	30,000	30,000	30,000	30,000	30,000	30,000	30,000
Surge arrester replacement Gisborne 50kV	Condition										
	Compliance	30,000									
Fault Replacement Line	Condition										
	Compliance	40,000	40,000	40,000	40,000	40,000	40,000	40,000	40,000	40,000	40,000
OB Insulator Replacement	Condition										
	Compliance	30,000	30,000	30,000	30,000	30,000	30,000	30,000	30,000	30,000	30,000
Mahia 33kV line extension and Substation	Development	1,500,000									
11kV Lines and Cables		2,706,000	2,470,200	2,202,000	2,238,000	2,245,000	2,560,000	2,397,200	2,427,700	2,428,750	2,350,000
Age Replacement 300 poles per year	Condition										
	Compliance	1,000,000	1,100,000	1,100,000	1,100,000	1,100,000	1,100,000	1,100,000	1,100,000	1,100,000	1,100,000
Conductor replacement 15km	Condition										
	Compliance	390,000	390,000	390,000	390,000	390,000	390,000	390,000			
Conductor replacement 30km from 2013	Condition										
	Compliance								900,000	900,000	900,000
Conductor Age Replacement/OH Rationalisation - General 2km	Condition										
	Compliance	60,000	60,000	60,000	60,000	60,000	60,000	60,000	60,000	60,000	60,000
Uneconomic Rural Line replacement 10km	Condition										
	Compliance				300,000	300,000	300,000	300,000			
Unplanned Network Extention Allowance Line 1km	Growth	180,000	90,000	90,000	90,000	90,000	90,000	90,000	90,000	90,000	90,000
Unplanned Network Extention Allowance Cable 1km	Growth	200,000	200,000	200,000	200,000	200,000	200,000	200,000	200,000	200,000	200,000
Mahia Reconductor 5km	Growth	150,000									
Matawhero-Muriwai 11kV Line	Growth	135,000									
Dalton Feeder Moana Rd bypass 1.4km	Growth				98,000						

Ngatapa to Otoko Hill 8km	Growth			250,000							
Reinforce 13km Cricklewood Spur	Growth							200,000		190,000	
Cable Childers Disraeli Corner 300m	Growth	60,500									
Cable Roebuck Rd Palmerston Corner 300m	Growth	60,500									
Cable Roebuck Rd Bridge 350m	Growth	70,000									
Cable Carnarvon Sub to Childers Rd 560m	Growth			112,000							
Cable Plunket Sub to Ormond Rd 320m	Growth									67,200	
Cable City Feeder (Paknsave) 525m	Growth						105,000				
Cable Kahutia St feeder 1100m	Growth							220,000			
Cable Reids Quay to IRD 290m	Growth	60,900									
Cable IRD to Plunket Sub 330m	Growth	69,300									
Cable Weigh Bridge to Hirini St 370m	Growth									77,700	
Cable Oak to Stout St 375m	Growth										78,750
Gladstone Rd Project	Development	400,000	500,000								
LT Lines and Cables		450,000	450,000	450,000	450,000	450,000	450,000	450,000	450,000	450,000	450,000
Line Replacement 1km	Condition Compliance	40,000	40,000	40,000	40,000	40,000	40,000	40,000	40,000	40,000	40,000
Pole replacement 50 per year	Condition Compliance	100,000	100,000	100,000	100,000	100,000	100,000	100,000	100,000	100,000	100,000
Age replacement Cables 1km	Condition Compliance		80,000	80,000	80,000	80,000	80,000	80,000	80,000	80,000	80,000
Line Replacement with Underground 2km	Condition Compliance	150,000	150,000	150,000	150,000	150,000	150,000	150,000	150,000	150,000	150,000
Allowance for Growth Cables 1km	Growth	160,000	80,000	80,000	80,000	80,000	80,000	80,000	80,000	80,000	80,000
Service Connections		70,000	70,000	70,000	70,000	70,000	20,000	20,000	20,000	20,000	20,000
New Service Fuse Boxes to Replace Fibreglass Boxes 40pa	Condition Compliance	40,000	40,000	40,000	40,000	40,000					

Service Box Replacement 20 p.a.	Condition Compliance	0	0				20,000	20,000	20,000	20,000	20,000
New Service Fuse Boxes to Replace Meter Box Sharing 40 pa	Condition Compliance	30,000	30,000	30,000	30,000	30,000					
Load Control		350,000	250,000	350,000	350,000	250,000	0	0	0	0	0
Replace contactors with ripple relays 1000 pa	Performance	250,000	250,000	250,000	250,000	250,000	0				
Relocation Valley Rd Injection Plant to Wairoa	Performance										
Acquire Spares and Install second Injection Point Gisborne	Performance	100,000		100,000	100,000						
Zone Substations		150,000	570,000	520,000	520,000	10,000	10,000	260,000	460,000	410,000	10,000
T1 2.5MW and new sub Whangara (overcomes capacity issues of Kaiti and Tolaga)	Development								450,000	400,000	
Replace T1 at Tolaga 2.5MW	Condition Compliance			500,000							
Replace T1 Patutahi 5.0MW	Condition Compliance				500,000						
Replace T1 Puha 5.0MW	Condition Compliance							250,000			
Kaiti install replacement fence Building Security Systems Replacement	Condition Compliance		20,000	20,000	20,000	10,000	10,000	10,000	10,000	10,000	10,000
Replace T1 Ngatapa 2.5MVA	Growth	150,000	550,000								
50kV CB's		0	0	160,000	160,000	260,000	0	0	0	80,000	80,000
TeAraroa	Condition Compliance			80,000							
Ruatoria T1	Condition Compliance				80,000						
Ruatoria Line to TeAraroa	Condition Compliance				80,000						
Tokomaru T1	Condition Compliance					80,000					
Tokomaru Line to Ruatoria	Condition Compliance					80,000					
Tolaga T1	Condition Compliance			80,000							

Carnarvon T1	Condition Compliance									80000	
Makaraka Line to Patutahi	Condition Compliance										80000
Pehiri CB replacement	Condition Compliance					100,000					
11kV CB's		205,290	0	0	0	0	0	0	0	0	0
Field Recloser Automation Plan	Performance	205,290									
Distribution Transformers		577,000	577,000	577,000	577,000	577,000	577,000	577,000	577,000	577,000	577,000
Transformers <100kVA	Condition Compliance	100000	100000	100000	100000	100000	100000	100000	100000	100000	100000
Transformers >100kVA	Condition Compliance	255000	255000	255000	255000	255000	255000	255000	255000	255000	255000
Earthing Upgrades	Condition Compliance	4,000	4,000	4,000	4,000	4,000	4,000	4,000	4,000	4,000	4,000
Transformers Growth <100kVA	Growth	78,000	78,000	78,000	78,000	78,000	78,000	78,000	78,000	78,000	78,000
Transformers Growth >100kVA	Growth	140,000	140,000	140,000	140,000	140,000	140,000	140,000	140,000	140,000	140,000
Pole Mounted Isolation Equipment		127,000	127,000	127,000	64,500	64,500	64,500	64,500	64,500	64,500	64,500
Age Replacement of 11kV ABS's 20pa to 2008	Condition Compliance	115,000	115,000	115,000							
Age Replacement of 11kV ABS's 9pa from 2009	Condition Compliance				52,500	52,500	52,500	52,500	52,500	52,500	52,500
11kV Fuse replacement 10sets	Condition Compliance	12,000	12,000	12,000	12,000	12,000	12,000	12,000	12,000	12,000	12,000
11kV Ground Mounted Switchgear		183,500	131,000	131,000	131,000	131,000	231,000	131,000	131,000	231,000	231,000
New Connections	Growth	81,000	81,000	81,000	81,000	81,000	81,000	81,000	81,000	81,000	81,000
Switchgear Replacement unplanned	Condition Compliance		50,000	50,000	50,000	50,000	50,000	50,000	50,000	50,000	50,000
Switchgear Replacement plan	Condition Compliance	102,500					100,000			100,000	100,000

LV Switchgear		80,000	80,000	80,000	40,000	40,000	40,000	40,000	40,000	40,000	40,000
Replace J Type LV Pillars (6 boxes p.a.)	Condition Compliance	40,000	40,000	40,000							
Allowance for New Installations	Growth	40,000	40,000	40,000	40,000	40,000	40,000	40,000	40,000	40,000	40,000
Control and Protection		63,000	125,000	115,000	120,000	25,000	25,000	25,000	130,000	30,000	30,000
Replace Batteries / Charges	Condition Compliance	33,000	15,000	15,000	15,000	15,000	15,000	15,000	15,000	15,000	15,000
Replace AVR Relays	Condition Compliance		10,000	10,000	15,000				5000	5000	5000
Replace 50kV Protection	Condition Compliance	20,000							20000		
Allowance for premature failure	Condition Compliance	10,000	10,000	10,000	10,000	10,000	10,000	10,000	10,000	10,000	10,000
Replace 11kV Protection	Condition Compliance		90,000	80,000	80,000				80000		
Communications		104,000	80,000	80,000	80,000	80,000	80,000	80,000	80,000	80,000	80,000
Planned Equipment replacements	Condition Compliance		60,000	60,000	60,000	60,000	60,000	60,000	60,000	60,000	60,000
Digital Link Whakapunake	Condition Compliance	50,000									
Unplanned Replacements	Condition Compliance	24,000	20,000	20,000	20,000	20,000	20,000	20,000	20,000	20,000	20,000
Long term development additional sites	Growth										
New Technology upgrades	Growth	30,000									
SCADA		22,000	80,000	112,000	82,000	172,000	172,000	172,000	52,000	52,000	52,000
Development and Replacement on 10 Year Cycle	Condition Compliance					120,000	120,000	120,000			
Radio Site monitoring equipment Replacement	Condition Compliance			30,000							
RTU Replacement	Condition Compliance	12,000	12,000	12,000	12,000	12,000	12,000	12,000	12,000	12,000	12,000
Master Station Development short term	Performance	10,000	10,000	10,000	10,000	10,000	10,000	10,000	10,000	10,000	10,000
Rural Automation	Performance		48,000	50,000	50,000	20,000	20,000	20,000	20,000	20,000	20,000
Long term development additional sites	Performance		10,000	10,000	10,000	10,000	10,000	10,000	10,000	10,000	10,000

Ntk Depreciation	3,433,790	3,567,673	3,602,319	3,691,071	3,745,747	3,827,119	3,728,911	3,753,589	3,624,890	3,603,128
Condition Compliance	3,027,500	3,103,000	3,783,000	3,955,500	3,570,500	3,360,500	3,510,500	3,455,500	3,535,500	3,535,500
Growth/Security	1,535,000	1,389,200	1,071,000	807,000	814,000	1,129,000	966,200	786,700	787,750	709,000
Performance/Development	2,355,290	818,000	420,000	420,000	290,000	40,000	40,000	490,000	440,000	40,000
Capex Total	6,917,790	5,310,200	5,274,000	5,182,500	4,674,500	4,529,500	4,516,700	4,732,200	4,763,250	4,284,500

Capital Expenditure by Category

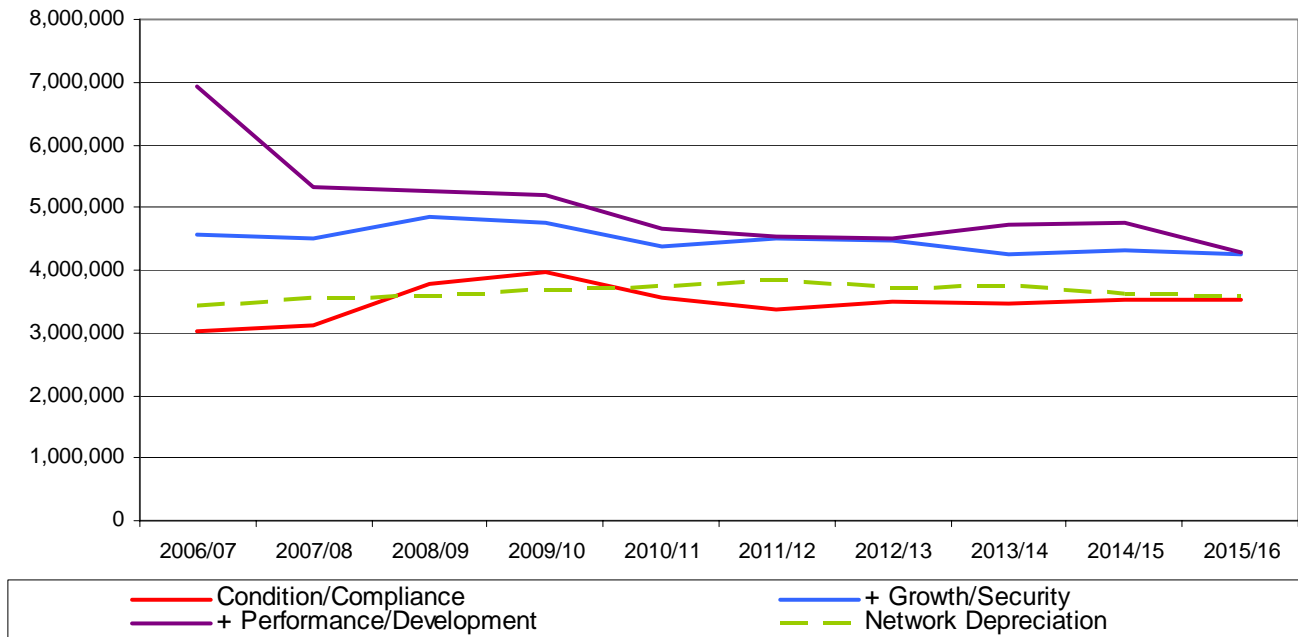

Capital Expenditure by Asset Type

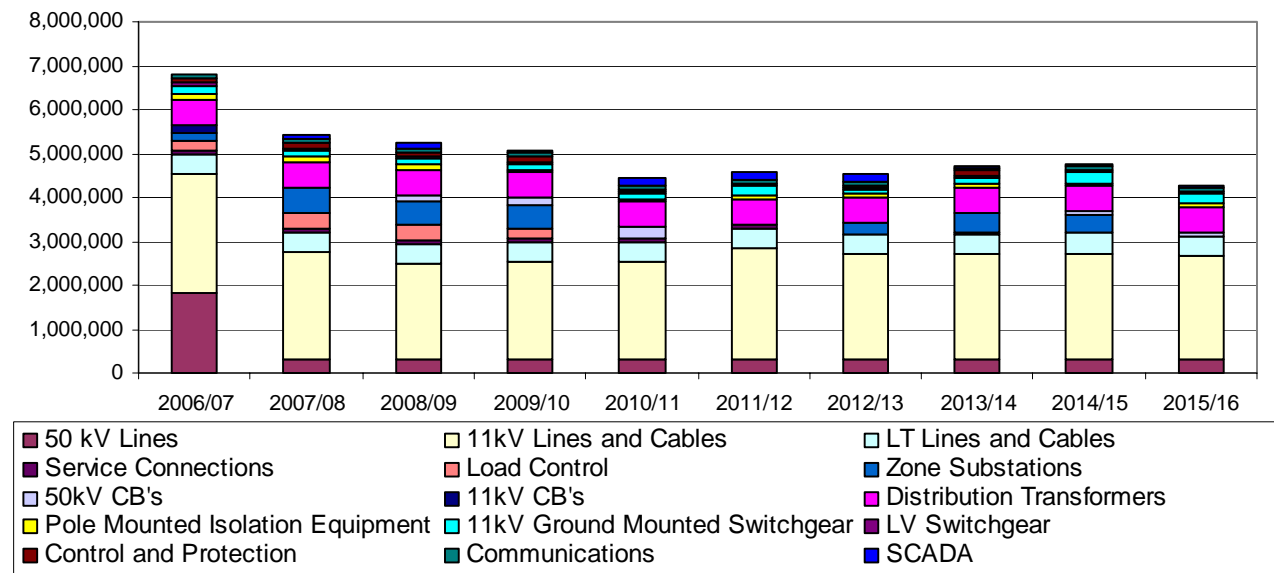

7.3.2 Maintenance expenditure

Total maintenance expenditure over the planning period, as described in Section 5.3, is \$17.932 m. The expenditure profile is relatively flat indicating steady state assumptions apply.

As described in Section 2.3, it has been identified that ENL’s distribution assets are in the age replacement phase of their life cycle. The management tactic is to therefore replace rather than to continue with a heavy maintenance strategy. The expected improvement in average asset condition will lift performance and allows low maintenance expenditure to be sustained.

Below the maintenance expenditure trend forecasted for the planning period is illustrated graphically and is provided in full in tabular form according to asset type and activity.

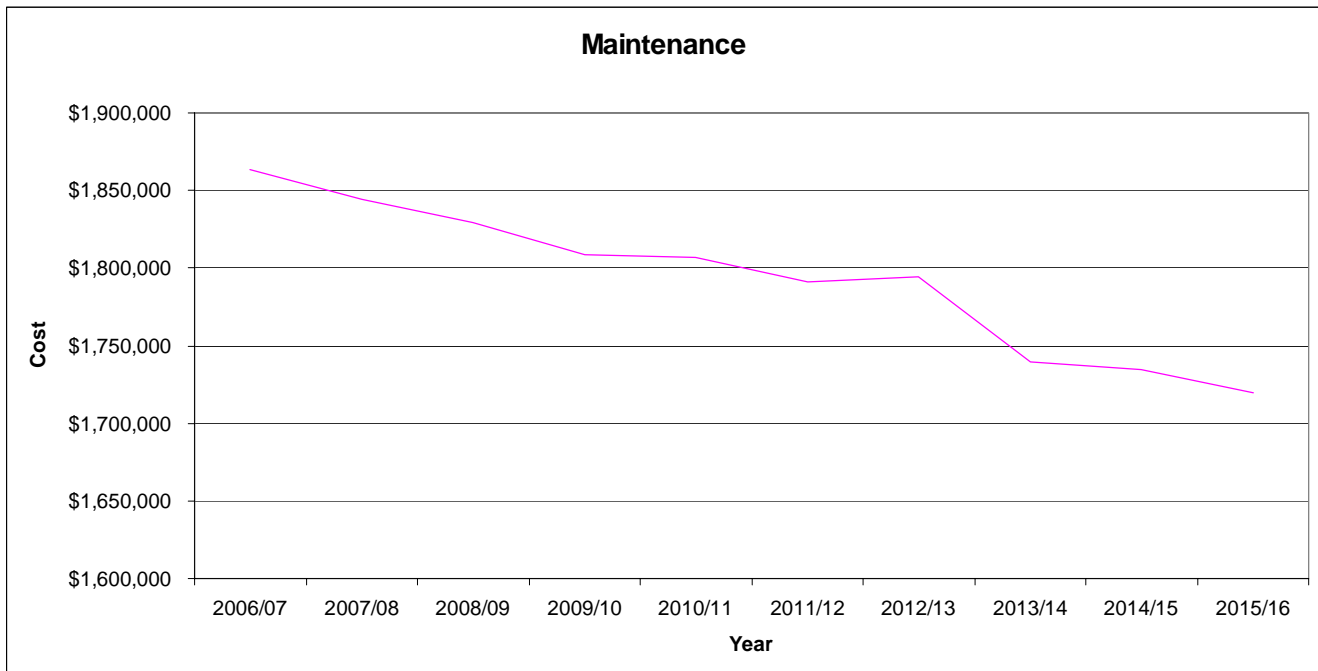

Maintenance 2006/07 to 2015/16					2006/07	2006/07	Unplanned									
Category	Planned/Unplanned	Description	Quantity	Rate	Planned Cost	Cost	2006/07	2007/08	2008/09	2009/10	2010/11	2011/12	2012/13	2013/14	2014/15	2015/16
50kV Lines	Planned Actions	Patrols (Ground & Helicopter)	2,000	\$ 12	\$ 24,000	\$ 24,000	\$ 24,000	\$ 24,000	\$ 24,000	\$ 24,000	\$ 24,000	\$ 24,000	\$ 24,000	\$ 24,000	\$ 24,000	\$ 24,000
50kV Lines	Planned Actions	Inspections (Climbing)	133	\$ 150	\$ 20,000	\$ 20,000	\$ 20,000	\$ 20,000	\$ 20,000	\$ 20,000	\$ 20,000	\$ 20,000	\$ 20,000	\$ 20,000	\$ 20,000	\$ 20,000
50kV Lines	Planned Actions	Testing - Ultrasound scan (Poles)	200	\$ 50	\$ 10,000	\$ 10,000	\$ 10,000	\$ 10,000	\$ 10,000	\$ 10,000	\$ 10,000	\$ 10,000	\$ 10,000	\$ 10,000	\$ 10,000	\$ 10,000
50kV Lines	Planned Actions	Thermovision/Ultrasound	40km	\$ 500	\$ 20,000	\$ 20,000	\$ 20,000	\$ 20,000	\$ 20,000	\$ 20,000	\$ 20,000	\$ 20,000	\$ 20,000	\$ 20,000	\$ 20,000	\$ 20,000
50kV Lines	Unplanned Actions	Defect / Fault repairs				\$ 13,122	\$ 13,122	\$ 12,500	\$ 12,500	\$ 12,500	\$ 12,500	\$ 12,500	\$ 12,500	\$ 12,000	\$ 12,000	\$ 12,000
50kV Lines	Unplanned Actions	Fault response (incl Helicopter)	12	\$ 1,800	\$ 21,600	\$ 21,000	\$ 21,000	\$ 19,800	\$ 19,800	\$ 19,800	\$ 19,800	\$ 19,800	\$ 19,800	\$ 18,000	\$ 18,000	\$ 18,000
50kV Lines	Unplanned Actions	Radio Interference correction	4	\$ 2,000	\$ 8,000	\$ 8,000	\$ 8,000	\$ 6,000	\$ 6,000	\$ 6,000	\$ 6,000	\$ 6,000	\$ 6,000	\$ 4,000	\$ 4,000	\$ 4,000
50kV Lines	Planned Actions	Faults Management			\$ 15,240	\$ 15,240	\$ 15,240	\$ 15,240	\$ 15,240	\$ 15,240	\$ 15,240	\$ 15,240	\$ 15,240	\$ 15,240	\$ 15,240	\$ 15,240
11kv Lines Cables	Planned Actions	Patrols	250km	\$ 120	\$ 30,000	\$ 30,000	\$ 30,000	\$ 30,000	\$ 30,000	\$ 30,000	\$ 30,000	\$ 30,000	\$ 30,000	\$ 30,000	\$ 30,000	\$ 30,000
11kv Lines Cables	Planned Actions	Testing -Ultrasound scan (Poles)	600	\$ 50	\$ 30,000	\$ 30,000	\$ 40,000	\$ 40,000	\$ 40,000	\$ 40,000	\$ 40,000	\$ 40,000	\$ 40,000	\$ 40,000	\$ 40,000	\$ 40,000
11kv Lines Cables	Planned Actions	Testing -Partial discharge (Cables)	10	\$ 440	\$ 4,400	\$ 4,440	\$ 4,440	\$ 4,440	\$ 4,440	\$ 4,440	\$ 4,440	\$ 4,440	\$ 4,440	\$ 4,440	\$ 4,440	\$ 4,440
11kv Lines Cables	Planned Actions	Tree control program			\$ 174,000	\$ 174,000	\$ 180,000	\$ 180,000	\$ 180,000	\$ 180,000	\$ 180,000	\$ 180,000	\$ 180,000	\$ 180,000	\$ 130,000	\$ 130,000
11kv Lines Cables	Planned Actions	Storm Contengency			\$ 100,000	\$ 100,000	\$ 100,000	\$ 100,000	\$ 100,000	\$ 100,000	\$ 100,000	\$ 100,000	\$ 100,000	\$ 100,000	\$ 100,000	\$ 100,000
11kv Lines Cables	Unplanned Actions	Trees forced cutting	100	\$ 400	\$ 40,000	\$ 40,000	\$ 40,000	\$ 40,000	\$ 40,000	\$ 40,000	\$ 40,000	\$ 40,000	\$ 40,000	\$ 80,000	\$ 80,000	\$ 80,000
11kv Lines Cables	Unplanned Actions	Defect / Fault repairs			\$ 210,703	\$ 210,703	\$ 210,000	\$ 210,000	\$ 210,000	\$ 210,000	\$ 200,000	\$ 200,000	\$ 200,000	\$ 200,000	\$ 190,000	\$ 190,000
11kv Lines Cables	Unplanned Actions	Fault response	120	\$ 1,000	\$ 120,000	\$ 120,000	\$ 120,000	\$ 120,000	\$ 120,000	\$ 120,000	\$ 120,000	\$ 120,000	\$ 120,000	\$ 120,000	\$ 120,000	\$ 120,000
11kv Lines Cables	Unplanned Actions	Control and dispatch costs			\$ 20,000	\$ 20,000	\$ 20,000	\$ 20,000	\$ 20,000	\$ 20,000	\$ 20,000	\$ 20,000	\$ 20,000	\$ 15,000	\$ 15,000	\$ 15,000
11kv Lines Cables	Planned Actions	Faults Management			\$ 118,500	\$ 118,500	\$ 118,500	\$ 118,500	\$ 118,500	\$ 118,500	\$ 118,500	\$ 118,500	\$ 118,500	\$ 118,500	\$ 118,500	\$ 118,500
400v Lines Cables	Planned Actions	Patrols	50km	\$ 200	\$ 10,000	\$ 10,000	\$ 10,000	\$ 10,000	\$ 10,000	\$ 10,000	\$ 10,000	\$ 10,000	\$ 10,000	\$ 10,000	\$ 10,000	\$ 10,000
400v Lines Cables	Planned Actions	Testing -Ultrasound scan (Poles)	300	\$ 50	\$ 15,000	\$ 15,000	\$ 15,000	\$ 15,000	\$ 15,000	\$ 15,000	\$ 15,000	\$ 15,000	\$ 15,000	\$ 15,000	\$ 15,000	\$ 15,000
400v Lines Cables	Unplanned Actions	Defect / Fault repairs			\$ 50,000	\$ 50,000	\$ 50,000	\$ 50,000	\$ 50,000	\$ 48,000	\$ 48,000	\$ 48,000	\$ 48,000	\$ 48,000	\$ 45,000	\$ 45,000
400v Lines Cables	Unplanned Actions	Fault response	100	\$ 250	\$ 25,000	\$ 25,000	\$ 25,000	\$ 25,000	\$ 25,000	\$ 23,000	\$ 23,000	\$ 23,000	\$ 23,000	\$ 20,000	\$ 20,000	\$ 20,000
400v Lines Cables	Planned Actions	Faults Management			\$ 14,850	\$ 14,850	\$ 14,850	\$ 14,850	\$ 14,850	\$ 14,850	\$ 14,850	\$ 14,850	\$ 14,850	\$ 14,850	\$ 14,850	\$ 14,850
Service Connections	Planned Actions	Patrols/inspection	500	\$ 10	\$ 5,000	\$ 5,000	\$ 5,000	\$ 5,000	\$ 5,000	\$ 5,000	\$ 5,000	\$ 5,000	\$ 5,000	\$ 5,000	\$ 5,000	\$ 5,000
Service Connections	Unplanned Actions	Voltage Checks/Complaints	100	\$ 200	\$ 20,000	\$ 20,000	\$ 20,000	\$ 20,000	\$ 20,000	\$ 20,000	\$ 20,000	\$ 20,000	\$ 20,000	\$ 20,000	\$ 20,000	\$ 20,000
Load Control	Planned Actions	Injection plant testing	2	\$ 4,000	\$ 8,000	\$ 8,000	\$ 8,000	\$ 8,000	\$ 8,000	\$ 8,000	\$ 8,000	\$ 8,000	\$ 8,000	\$ 8,000	\$ 8,000	\$ 8,000
Load Control	Unplanned Actions	Defect repairs / replacement costs			\$ 5,000	\$ 5,000	\$ 5,000	\$ 5,000	\$ 5,000	\$ 5,000	\$ 5,000	\$ 5,000	\$ 5,000	\$ 5,000	\$ 5,000	\$ 5,000
Load Control	Unplanned Actions	Fault response (Pilot circuits)	36	\$ 250	\$ 9,000	\$ 9,000	\$ 8,000	\$ 2,000	\$ -	\$ -	\$ -	\$ -	\$ -	\$ -	\$ -	\$ -
Load Control	Planned Actions	Faults Management			\$ 2,970	\$ 2,970	\$ 2,970	\$ 2,970	\$ 2,970	\$ 2,970	\$ 2,970	\$ 2,970	\$ 2,970	\$ 2,970	\$ 2,970	\$ 2,970

Zone Substations	Planned Actions	3 Monthly Inspections	100	\$	250	\$	25,000	\$	25,000	\$	25,000	\$	25,000	\$	25,000	\$	25,000	\$	25,000	\$	25,000	\$	25,000	\$	25,000	\$	25,000	\$	25,000		
Zone Substations	Planned Actions	Grounds Maintenance	240	\$	125	\$	30,000	\$	30,000	\$	30,000	\$	30,000	\$	30,000	\$	30,000	\$	30,000	\$	30,000	\$	30,000	\$	30,000	\$	30,000	\$	30,000		
Zone Substations	Planned Actions	Safety Equipment Inspections and testing	40	\$	250	\$	10,000	\$	10,000	\$	10,000	\$	10,000	\$	10,000	\$	10,000	\$	10,000	\$	10,000	\$	10,000	\$	10,000	\$	10,000	\$	10,000		
Zone Substations	Planned Actions	Occupational Health and safety Inspection	20	\$	250	\$	5,000	\$	5,000	\$	5,000	\$	5,000	\$	5,000	\$	5,000	\$	5,000	\$	5,000	\$	5,000	\$	5,000	\$	5,000	\$	5,000		
Zone Substations	Planned Actions	Thermo vision AND Ultrasound Inspections	20	\$	250	\$	5,000	\$	5,000	\$	5,000	\$	5,000	\$	5,000	\$	5,000	\$	5,000	\$	5,000	\$	5,000	\$	5,000	\$	5,000	\$	5,000		
Zone Substations Transformers	Planned Actions	Transformer painting	2	\$	7,500	\$	15,000	\$	15,000	\$	-	\$	15,000	\$	-	\$	15,000	\$	-	\$	15,000	\$	-	\$	15,000	\$	-	\$	15,000		
Zone Substations	Planned Actions	Average Routine Maintenance		\$		\$	70,000	\$	70,000	\$	65,000	\$	65,000	\$	65,000	\$	65,000	\$	65,000	\$	65,000	\$	65,000	\$	65,000	\$	65,000	\$	65,000		
Zone Substations	Unplanned Actions	Defect / Fault repairs		\$		\$	25,000	\$	25,000	\$	25,000	\$	25,000	\$	25,000	\$	25,000	\$	25,000	\$	25,000	\$	25,000	\$	25,000	\$	25,000	\$	25,000		
Zone Substations	Unplanned Actions	Fault response		\$	4,100	\$	4,100	\$	4,100	\$	4,100	\$	4,100	\$	4,100	\$	4,100	\$	4,100	\$	4,100	\$	4,100	\$	4,100	\$	4,100	\$	4,100	\$	4,100
Zone Substations	Planned Actions	Faults Management		\$	4,610	\$	4,610	\$	4,610	\$	4,610	\$	4,610	\$	4,610	\$	4,610	\$	4,610	\$	4,610	\$	4,610	\$	4,610	\$	4,610	\$	4,610	\$	4,610
Zone Substation Transformers	Planned Actions	DGA furrow tests p.a.	10	\$	1,000	\$	10,000	\$	10,000	\$	10,000	\$	10,000	\$	10,000	\$	10,000	\$	10,000	\$	10,000	\$	10,000	\$	10,000	\$	10,000	\$	10,000	\$	10,000
Zone Substation Transformers	Planned Actions	Average tap changer overhauls 1 unit p.a.	1	\$	15,000	\$	15,000	\$	15,000	\$	15,000	\$	15,000	\$	15,000	\$	15,000	\$	15,000	\$	15,000	\$	15,000	\$	15,000	\$	15,000	\$	15,000	\$	15,000
Zone Substation Transformers	Planned Actions	Average oil processing 2 p.a.	2	\$	6,000	\$	12,000	\$	12,000	\$	12,000	\$	12,000	\$	12,000	\$	12,000	\$	12,000	\$	12,000	\$	12,000	\$	12,000	\$	12,000	\$	12,000	\$	12,000
Circuit Breakers	Planned Actions	Annual Inspections (Rural CB's)	40	\$	250	\$	10,000	\$	10,000	\$	10,000	\$	10,000	\$	10,000	\$	10,000	\$	10,000	\$	10,000	\$	10,000	\$	10,000	\$	10,000	\$	10,000	\$	10,000
Circuit Breakers	Planned Actions	Average Routine Maintenance (Rural CB's)	8	\$	2,500	\$	20,000	\$	20,000	\$	20,000	\$	20,000	\$	20,000	\$	20,000	\$	20,000	\$	20,000	\$	20,000	\$	20,000	\$	20,000	\$	20,000	\$	20,000
Circuit Breakers	Unplanned Actions	Defect /Fault repairs	5	\$	3,000	\$	15,000	\$	15,000	\$	15,000	\$	15,000	\$	15,000	\$	15,000	\$	15,000	\$	15,000	\$	15,000	\$	15,000	\$	15,000	\$	15,000	\$	15,000
Transformers	Planned Actions	Refurbishment <100kVA	5	\$	1,400	\$	7,500	\$	7,500	\$	7,500	\$	7,500	\$	7,500	\$	7,500	\$	7,500	\$	7,500	\$	7,500	\$	7,500	\$	7,500	\$	7,500	\$	7,500
Transformers	Planned Actions	Refurbishment >100kVA	2	\$	4,000	\$	8,000	\$	8,000	\$	8,000	\$	8,000	\$	8,000	\$	8,000	\$	8,000	\$	8,000	\$	8,000	\$	8,000	\$	8,000	\$	8,000	\$	8,000
Transformers	Planned Actions	Painting Ground mount/graffiti	20	\$	150	\$	3,000	\$	3,000	\$	3,000	\$	3,000	\$	3,000	\$	3,000	\$	3,000	\$	3,000	\$	3,000	\$	3,000	\$	3,000	\$	3,000	\$	3,000
Transformers	Planned Actions	Inspection and MDI's	200	\$	50	\$	10,000	\$	10,000	\$	10,000	\$	10,000	\$	10,000	\$	10,000	\$	10,000	\$	10,000	\$	10,000	\$	10,000	\$	10,000	\$	10,000	\$	10,000
Transformers	Planned Actions	Oil Handling /filtering /TX disposal		\$		\$	10,000	\$	10,000	\$	10,000	\$	10,000	\$	10,000	\$	10,000	\$	10,000	\$	10,000	\$	10,000	\$	10,000	\$	10,000	\$	10,000	\$	10,000
Transformers	Planned Actions	Transformer 5 yearly Compliance checks	100	\$	50	\$	5,000	\$	5,000	\$	5,000	\$	5,000	\$	5,000	\$	5,000	\$	5,000	\$	5,000	\$	5,000	\$	5,000	\$	5,000	\$	5,000	\$	5,000
Transformers	Planned Actions	Earth testing	1000	\$	45	\$	45,000	\$	45,000	\$	45,000	\$	45,000	\$	45,000	\$	45,000	\$	45,000	\$	45,000	\$	45,000	\$	45,000	\$	45,000	\$	45,000	\$	45,000
Transformers	Planned Actions	Earthing system repairs	60	\$	500	\$	30,000	\$	30,000	\$	25,000	\$	25,000	\$	25,000	\$	25,000	\$	25,000	\$	25,000	\$	25,000	\$	25,000	\$	25,000	\$	25,000	\$	25,000
Transformers	Planned Actions	Oil Analysis	20	\$	300	\$	6,000	\$	6,000	\$	6,000	\$	6,000	\$	6,000	\$	6,000	\$	6,000	\$	6,000	\$	6,000	\$	6,000	\$	6,000	\$	6,000	\$	6,000
Transformers	Unplanned Actions	Defect /Fault repairs		\$		\$	15,000	\$	15,000	\$	15,000	\$	15,000	\$	15,000	\$	15,000	\$	15,000	\$	15,000	\$	15,000	\$	15,000	\$	15,000	\$	15,000	\$	15,000
Transformers	Unplanned Actions	Vegetation clearance		\$	1,000	\$	1,000	\$	1,000	\$	1,000	\$	1,000	\$	1,000	\$	1,000	\$	1,000	\$	1,000	\$	1,000	\$	1,000	\$	1,000	\$	1,000	\$	1,000
Transformers	Planned Actions	Faults Management		\$	3,700	\$	3,700	\$	3,700	\$	3,700	\$	3,700	\$	3,700	\$	3,700	\$	3,700	\$	3,700	\$	3,700	\$	3,700	\$	3,700	\$	3,700	\$	3,700
Pole Mounted Isolation Equipment	Planned Actions	Inspection and Testing	40	\$	300	\$	12,000	\$	12,000	\$	12,000	\$	12,000	\$	12,000	\$	12,000	\$	12,000	\$	12,000	\$	12,000	\$	12,000	\$	12,000	\$	12,000	\$	12,000
Pole Mounted Isolation Equipment	Unplanned Actions	Defect /Fault repairs		\$		\$	10,000	\$	10,000	\$	10,000	\$	10,000	\$	10,000	\$	10,000	\$	10,000	\$	10,000	\$	10,000	\$	10,000	\$	10,000	\$	10,000	\$	10,000
Pole Mounted Isolation Equipment	Planned Actions	Faults Management		\$	3,000	\$	3,000	\$	3,000	\$	3,000	\$	3,000	\$	3,000	\$	3,000	\$	3,000	\$	3,000	\$	3,000	\$	3,000	\$	3,000	\$	3,000	\$	3,000
11kV Switchgear Ground Mounted	Planned Actions	Annual Inspection	167	\$	60	\$	10,000	\$	10,000	\$	10,000	\$	10,000	\$	10,000	\$	10,000	\$	10,000	\$	10,000	\$	10,000	\$	10,000	\$	10,000	\$	10,000	\$	10,000

7.4 How is the asset value changing

Ideally ENL’s asset value should remain fairly constant given the average position in terms of security and performance and general satisfaction, across the consumer base with the security/performance verses price trade off currently provided. Any decline of service potential associated with the aging asset should be off-set by an equal restoring of service potential. Factors that will influence the asset value are shown in Table 7.4(a) below...

Table 7.4(a) – Factors influencing asset value

Factors that increase asset value	Factors that decrease asset value
Addition of new assets to the network as a result of improvements to Security and Performance levels or new asset in response to growth.	Removal of assets from the network generally associated with moving industrial and commercial load centers.
Renewal of existing assets. Note the definition of renewal as being restoration of original functionality – no increase in service potential beyond original functionality.	On-going depreciation of assets.
Increase of standard component values implicit in the ODV methodology.	Reduction of standard component values implicit in the ODV methodology.

At a practical level ENL’s asset valuation will vary even in the absence of component revaluations. This is principally because the accounting treatment of depreciation models the decline in service potential as a straight line (when in most cases it is more closely reflected by an inverted bath-tub curve) whilst the restoration of service potential is very “lumpy”. However the aggregation of many depreciating assets and many restoration projects tends to smooth short-term variations in asset value.

The asset value ratio across the urban and rural assets is changing. The urban asset value is increasing as the rural asset value is decreasing. This shift is in line with the greater levels of security and higher performance levels provided in the urban centers. The shift is also influenced by economic justification. With controls on the differential between more economic urban and less uneconomic rural tariffs, the matching of expenditure, affecting asset condition and age, to income, ultimately results in a corresponding shift of asset value.

7.5 Depreciation and Renewal of the assets

ENL has identified a developing gap between required renewal rates to maintain asset age and current targeted rates, primarily limited by available funding.

The nature of the existing asset is such that it will physically deteriorate over its life until it reaches a stage where renewal is required to maintain service. In addition the life expectancies of the components making up the asset are varied which affects the accuracy of renewal forecasts. The renewal costs for these asset components need to be provided for over their respective lives.

Depreciation provides the mechanism to fund this renewal.

The ability for renewal to be funded by depreciation is affected by-

- The correct value being assigned to the assets
- The correct age expectancy being assigned to the assets
- Stability of the costs for the new equivalent asset over time.
- Selection of the correct asset components to be removed.

The asset value for ENL has been determined by the ODV methodology. This methodology values the existing asset assuming no asset exists initially, 'Green fields approach' and lowest standard cost of the minimum required asset over a 10 year planning cycle. This method of valuation differs from the actual renewal situation in the following areas...

- Renewal costs include costs to remove the existing asset and maintain service while the new asset is installed.
- The planning period adopted for new assets is generally greater than 10 years to align more closely with asset life hence avoiding frequent upgrade on an in-service asset that is difficult to access.
- At the component level it is often appropriate to change assets not at end of life in conjunction with the asset targeted for renewal.

Any short fall between depreciation funding and renewal cost must be provided from some other source.

The justifiable growth component of renewal expenditure can be sourced from growth funding made available from growth revenue or borrowing.

Higher charges or reduction in the Return on Asset provided to the share holder can also provide the additional funding.

Finally retiring of the asset at the time of failure, with the resulting reduction or total loss of service is a consideration.

Given set requirements for shareholder expectations ,set requirements from regulators for revenue, defined limits and justifications on borrowing levels and the need to allocate funding to growth and performance improvement, ENL has identified a gap developing between forecast required renewal rates and the target rates that can be financially achieved. This will be particularly

significant as ENL approaches the “bow wave” of asset renewals that can be seen in the age profiles for asset components.

The renewal section of this plan identifies the forecast and targeted renewal rates ENL has adopted. For 11kV conductor and poles, a gap as described above is currently developing. For the general case while the set limits remain in place the average age of the asset is increasing and the performance is likely to decline. The observable effects of the declining performance are being offset in the medium term by technology innovations that can be implemented at lower cost than the renewal alternative. Also ENL has identified medium term options to minimise this issue for remote or uneconomic lines which focus on improving systems to target the components requiring renewal more precisely and allowing failures while ensuring backup systems are adequate to maintain performance.

ENL’s conclusion is that at some point it must be given an opportunity to increase prices which will enable a balance to be achieved between the level of network investment required and return on asset requirements. Otherwise there is increased risk of performance failure in terms of regulation, customer expectation and sustainability of the business.

8. Performance & improvement

8.1 Performance against financial plans

ENL's financial year operates from 1 April to 31 March. The results for performance to budget for the previous 12 month asset management period 2005/06 for both capital and maintenance expenditure are shown in the tables below.

Capital Expenditure Comparison	2005/06 Budget	2005/06 Actual	Differen
Totals	\$ 9,124,946	\$ 6,519,145	\$ 2,605,801
Generation Peaking Plants	\$ 300,000	\$ 193,377	\$ 106,061
50 kV Lines	\$ 2,207,976	\$ 1,939,915	\$ 268,061
11kV Lines and Cables	\$ 2,902,900	\$ 1,885,888	\$ 1,017,012
LT Lines and Cables	\$ 610,000	\$ 392,010	\$ 217,990
Service Connections	\$ 70,000	\$ 60,780	\$ 9,220
Load Control	\$ 450,000	\$ 246,050	\$ 203,950
Zone Substations	\$ 1,130,000	\$ 488,643	\$ 641,357
50kV CB's	\$ 0	\$ 43,150	\$ (43,150)
11kV CB's	\$ 290,570	\$ 241,320	\$ 49,250
Distribution Transformers	\$ 667,000	\$ 632,130	\$ 34,870
Pole Mounted Isolation Equipment	\$ 127,000	\$ 148,112	\$ (21,112)
11kV Ground Mounted Switchgear	\$ 200,500	\$ 184,604	\$ 15,896
LV Switchgear	\$ 80,000	\$ 21,499	\$ 58,501
Control and Protection	\$ 13,000	\$ 7,198	\$ 5,802
Communications	\$ 54,000	\$ 25,260	\$ 28,740
SCADA	\$ 22,000	\$ 9,209	\$ 12,791
Condition/Compliance	\$3,504,500	\$2,861,918	\$642,582
Growth/Security	\$1,171,900	\$858,562	\$313,338
Performance/Development	\$4,448,546	\$2,798,665	\$1,649,881
Total	\$9,124,946	\$6,519,145	\$2,605,801

Capital Expenditure Comparison	Budget Planned 2005/06	Budget Unplanned 2005/06	Budget Total 2005/06	Actual 2005/06	Differen
Totals	\$ 1,112,400	\$ 818,310	\$ 1,930,710	\$ 1,604,138	\$ 326,572
50kV Lines	\$ 108,000	\$ 47,080	\$ 155,080	\$ 87,314	\$ 67,766
11kv Lines Cables	\$ 373,500	\$ 527,041	\$ 900,541	\$ 837,730	\$ 62,811
400v Lines Cables	\$ 44,000	\$ 78,165	\$ 122,165	\$ 107,333	\$ 14,832
Service Connections	\$ 5,000	\$ 29,160	\$ 34,160	\$ 24,461	\$ 9,699
Load Control	\$ 11,800	\$ 15,700	\$ 27,500	\$ 19,353	\$ 8,147
Zone Substations	\$ 177,900	\$ 29,100	\$ 207,000	\$ 169,991	\$ 37,009
Circuit Breakers	\$ 30,000	\$ 15,000	\$ 45,000	\$ 23,858	\$ 21,142
Transformers	\$ 128,200	\$ 16,000	\$ 144,200	\$ 130,377	\$ 13,823
Pole Mounted Isolation Equipment	\$ 15,000	\$ 11,664	\$ 26,664	\$ 9,081	\$ 7,583
11kV Switchgear Ground Mounted	\$ 101,000	\$ 11,400	\$ 112,400	\$ 72,753	\$ 39,647

LV Switchgear	\$	15,000	\$	12,000	\$	27,000	\$	13,470	\$	13,530
Communications	\$	62,000	\$	16,000	\$	78,000	\$	79,791	-\$	1,791
SCADA	\$	41,000	\$	10,000	\$	51,000	\$	28,626	\$	22,374

A total variation of \$2.932m under spend exists between the 2005/06 combined capital and maintenance expenditure budgets and the actual expenditure achieved. The reasons for this decrease in actual expenditure against budget were;

Capital Expenditure

A total variance of \$2.605m occurred between the 2005/06 budget and actual capital expenditure. Reasons for this variance are provided below in relation to the categories of capital expenditure.

The \$642k variance in Condition and Compliance, (renewal) expenditure was due to a shortage of available contractor resources. Both locally and nationally based contractors are depleted of skilled resources due to the legacy of 10 years of scaled back training of electrical workers and the financial attraction of overseas employment. Poor responses to tenders issued for renewal projects resulted in 20% of scheduled 11kV and 400V pole and conductor replacements being deferred. It was determined that limited local contracting resources were best utilized to carry out Development and performance capital expenditure projects.

The \$313k variance in Growth and Security expenditure occurred as a result of growth in specific segments of the network being less than forecast or significant load increases indicated by individual customers not occurring. Accordingly 26% of growth related upgrade and/or reinforcement capital expenditure was able to be deferred until growth triggers are reached. Specific expenditure that was deferred is;

- Wairere Rd 11kV conductor upgrade, \$45,000, residential subdivisions deferred by developer.
- Customhouse St to Reads Quay 11kV cable upgrade, \$49,400 and Reads Quay 11kV cable upgrade, \$63,000, Gisborne CBD load increase less than forecast.
- Unplanned 400V growth related cable upgrades \$97,000
- Unplanned 11kV growth related line upgrades \$58,000

The \$1.649m variation in Development and Performance expenditure resulted from the following deferrals, cancellations and savings;

- Load Control, \$200k of budgeted expenditure for purchase of spare components and establishment of a 2nd Gisborne injection point was deferred until 2006/07, (\$100k for spares) and 2009/10 (\$100k for 2nd injection point). These deferrals were made

following receipt of a consultants report on the performance of the current plant and options for future development.

- Mobile 650KVA Generator upgrade; \$100k of budgeted expenditure to install metering and synchronizing equipment on this generator was cancelled as a review determined that this expenditure was not economically justifiable because of the limited use of this generator.
- Rural Automation, \$80K of savings was achieved by reducing the scope of the project. The original scope included the installation of fault detection/monitoring units linked to SCADA but field trials of this equipment highlighted performance and reliability issues and the decision was made not to install them.
- Installation of 2nd 12.5MVA transformer at Parkinson St zone substation; \$181k savings were achieved on the completion of this two year project. The majority of the savings were the result of favorable foreign exchange rates related to the purchase of the 50/11kV transformer from India.
- Gladstone Road undergrounding and upgrading of 11kV, \$200k in savings was achieved in the first stage of this 3 year project through reduction of the project scope. The original scope and budget allowed for the undergrounding and capacity upgrade of the key 11kV feeder located in Gladstone Rd and the undergrounding of overhead conductors in side streets leading off Gladstone Rd. A review of the project concluded that the undergrounding of reticulation in side streets was not economically justifiable as they did not contribute to the upgrading of the key 11kv feeder which links 3 city zone substations.
- JNL to Parkinson 50kV ring, \$300k in savings were achieved on a total budget, (over 3 years) of \$2.380m.
- JNL zone substation, \$400k of savings was achieved on a total budget, (over 3 years) of \$1.4m. The majority savings were achieved through favorable foreign exchange rates relating to the purchase of a 12.5MVA 110/11kV transformer and 50kV circuit breakers and a change in the scope of the project which replaced the underground cable 50kV connection of the zone substation with an overhead connection.
- Carnarvon to Port 50kV ring, \$ 188k in savings were achieved on a total budget, (over 3 years) of \$2.110m.

Maintenance Expenditure

A total variance of \$326k occurred between the 2005/06 budget and actual maintenance expenditure. Reasons for this variance are as follows;

- Unplanned maintenance, \$137k in savings against a budget of \$818k. The 17% savings resulted from the actual cost of fault repairs being less than budgeted. The most significant savings

were realized in the 11kV Fault Response category of expenditure where a \$55k, (45%) saving occurred. In contrast to the overall savings, significant actual costs exceeding budget occurred in the categories of 400V Fault Repairs \$20k, (39%) and Load Control Fault Repairs \$5.1k, (102%).

- Planned maintenance, a \$189k variation against a budget of \$1.112m. The 16% reduction occurred primarily due to the lack of skilled contractor resources to carry out higher end activities such as load control plant injection testing and 50kV, 11kV, zone substation thermovision/ultrasound testing.

8.2 Meeting performance targets

The primary indicator of reliability performance is the SAIDI index. Besides inherent system security, a wide range of factors impact on observed reliability performance. The results for performance to disclosed reliability targets in previous plans with the actual results are as follows...

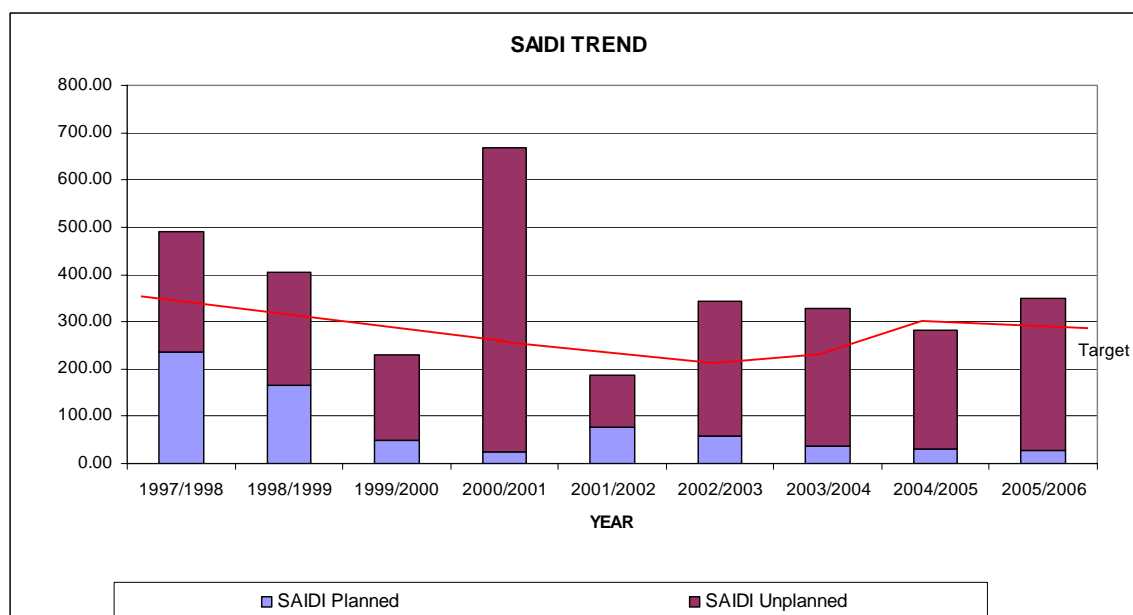

Protection and rural automation is an area where technology delivers large reductions in the impact of outages. ENL has progressively improved the network with this technology between 2000 and 2006. Optimisation of isolation points between 2000 and 2001 has also contributed to improved performance.

Introduction of Live-line maintenance policies between 1999 and 2000 has reduced the impact of planned outages from 2000.

Installation of remote diesel generators between 2002 and 2003 has further improved the impact of planned outages the extent of this improvement cannot be seen in the statistics as pole replacement on spur 50kV lines, previously deferred, was undertaken between 2003 and 2005 without any impact on outage statistics.

Significant storm events and environmental factors such as slips after long periods of, generally considered as normal, rainfall have the most significant impact on ENL's ability to achieve its targets. This is evident in the 2000/2001 result where a single 24 hour event contributed to 415.64 SAIDI minutes i.e. 64% of the years unplanned outages.

Other significant events are as follows...

- 2003/2004 130.36 Minutes July storm
- 2005/2006 83.83 Minutes October storm

Subtraction of these events shows ENL can obtain the target levels through activities it can control.

Cause analysis as a percentage of the total customers affected multiplied by-minutes of interruption time during the last year provides the following spread:

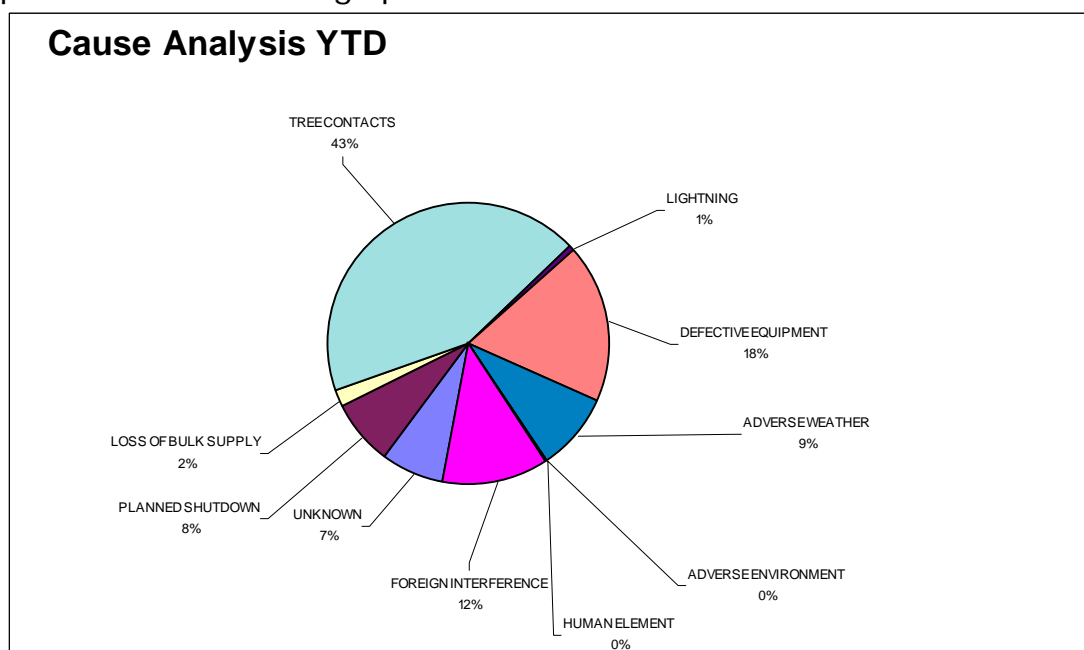

Planned shutdowns accounted for 8% of outage duration during 2005/06 a reduction from the previous period of 11%.

Actions have been taken to reduce the level of unknown causes 7% previously 20%, over recent years, since it frustrates an effective management response. Initiatives have included improved field fault reporting, automation projects, and follow-up patrols to short lived faults.

The adverse weather component is in effect indicative of poor or ageing asset condition, since power lines are designed for outdoor conditions for the duration of their design life with the conductor becoming a predominant issue. Under design is not normally an issue with the exception of extreme wind snow loading events every 2 or 3 years. Designing to these conditions is not considered economic and ENL chooses to manage this risk.

Foreign interference is increasing, previously at 9% the figure has climbed to 12%. This figure is driven by vehicles/pole collisions. Rural automation technology has minimised the impact of these faults however the number of incidents is increasing. The roading authorities have introduced new standards for location of structures alongside roads in 2006. All replacement structures need to conform to set minimum distances from the road edge or be protected by barriers. The costs to upgrade the existing works as part of the renewal will ultimately be borne by ENL's customers rather than the road users, under the new rules.

Bird strikes also contribute to this category. A long-term objective is to clean down structure design and increase separations to reduce bird strikes and animal interference.

Defective equipment is given as the cause for 18% of outages a rise from 16%. Faults in this category tend to have long repair times/high customer minutes. Causes are generally condition related resulting from assets remaining in service after their optimum replacement date hence the result is reflecting the decision to allow the asset in rural areas to increase in age. There is also an increasing trend for newer equipment to fail prior to expectations largely due to reduced quality and workmanship at manufacture. Standardisation on proven product, rigid specification and quality control procedures has been introduced to address this issue.

Defective equipment events (particularly pole failures) have reduced significantly since completion of the major Compliance Management Project undertaken in 2001–2002. This captured many age-related condition issues and brought performance more into line with normal expectations. Improvement of the ABS asset condition is being managed via long term replacement programs.

Conductor failure is expected to predominate in the future. This is discussed in lifecycle replacement plans.

Tree contacts have increased significantly to 43% from 6% in the previous period. The figure includes minor tree contacts flying tree debris and falling trees typically outside of the cut zone. The tree regulations and rules governing access to private property have influenced the poor result. As the rules have been implemented the notification processes involved have provided a window in which the

trees have encroached safe cut zones. Having grown within the safe cut zone, outages, which are also constrained to ensure regulatory targets are not breached, are now required to remove the trees. The approved resource trained to cut the trees safely is also limited. Over time ENL's expects to reduce the tree problems as much as practicable, within the requirements of the regulations, which are generally confined to inaccessible rural and remote areas, on privately owned sections of line or forestry blocks. Although the tree regulations provide for cost recovery from tree owners ENL's experience is that faults are likely to occur well before owners can act once the trees have reached the notice zone. Expenditure forecasts for tree control have been increased to compensate.

The Human element figure of 0% reflects the quality of safety standards and work practices in place to minimise contractor error.

8.3 Meeting Delivery Efficiency targets

Cost performance measures that are disclosed each year include:

- Direct cost / km
- Indirect cost / connection

The historical trends for ENL's efficiency targets compared with the industry position are as follows...

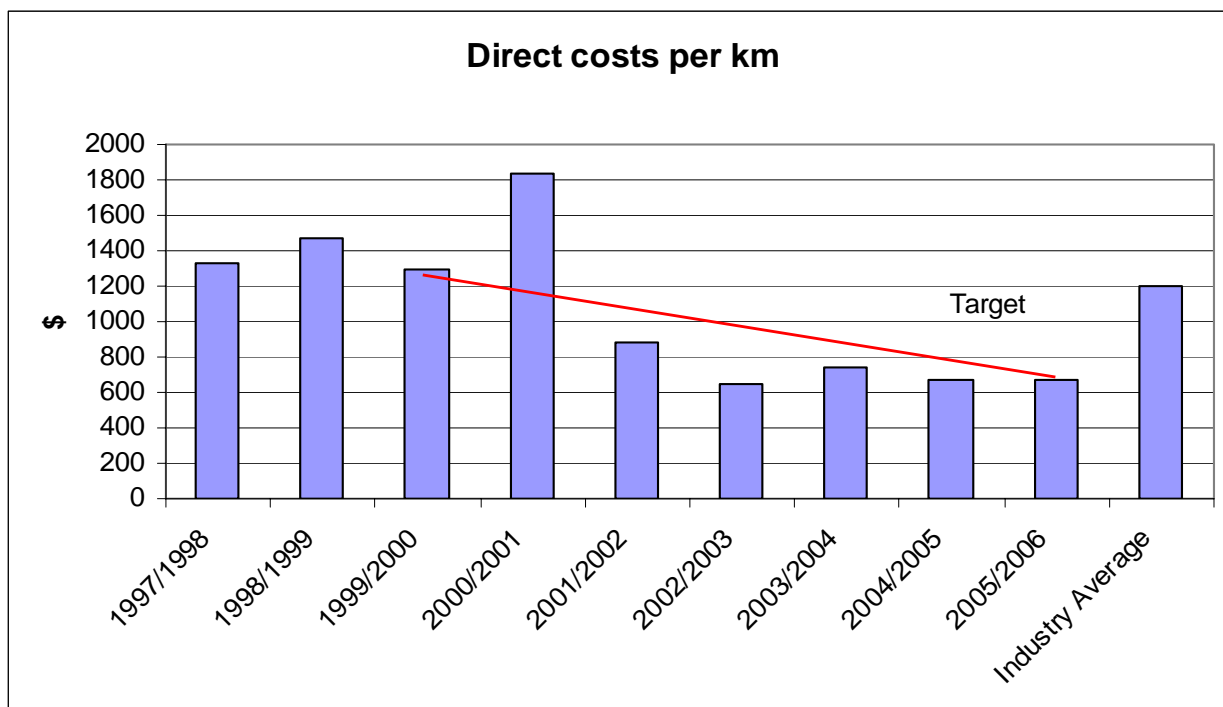

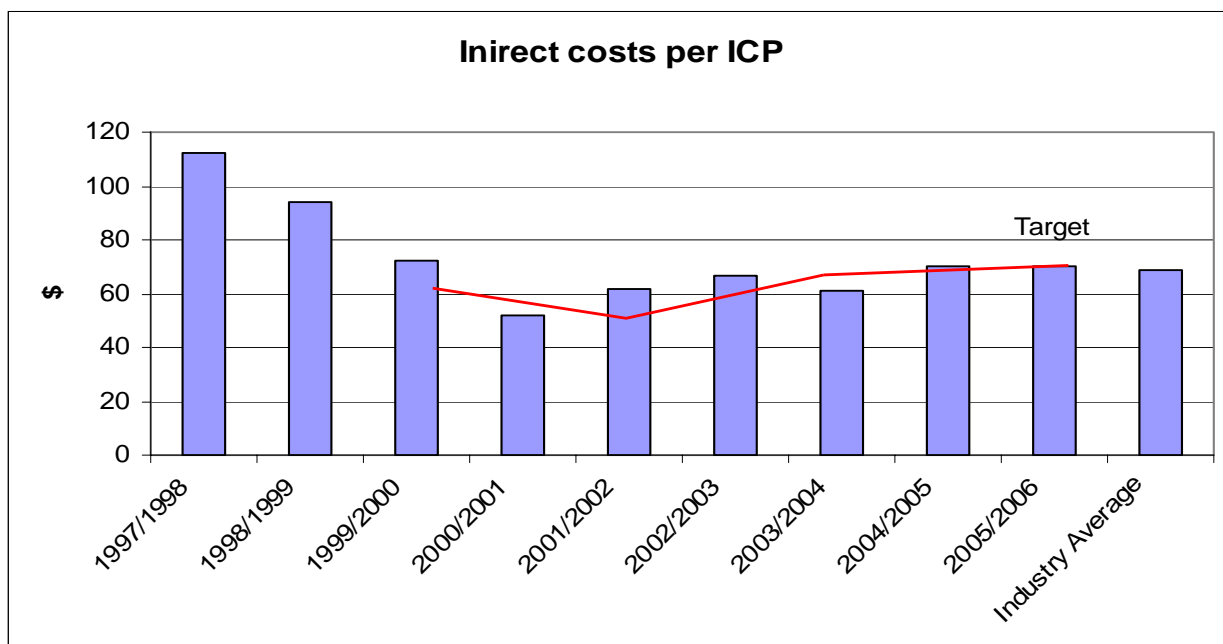

Note 2005/2006 Values are provisional

The trends are in line with current business targets and regulatory requirements.

8.3 Areas for Improvement

In general historical expenditure in any given period has been below the financial targets set. While deferral of costs is valid when forecast triggers do not occur at the time initially predicted, there is an increasing need to improve the reaction time frame once the expenditure requirement has occurred. The ability to predict the timing for necessary renewal and growth expenditure can also be improved.

The customer oriented service levels are currently being established, relying on representation from government, significant customers and key groups. Refer section 3.1. ENL has identified a need to develop a strategy to broaden the contact group and identify innovative methods to source statistically truer representation of the end users requirements.

The survey results to date have identified customers have issues but they are not asking for correction of these issues if the measures are linked to increased costs. Identification of methods to eliminate the issues without increasing costs disproportionately is necessary in order to improve the satisfaction of end users.

Asset Condition has been identified in the section 5.4 of this plan as having a gap in terms of currently targeted renewal quantities verses forecast expectations of asset failure for some asset categories. For 11kV lines this has also been considered in the development section of this plan. The installation profile of the overall asset and historical practices has provided a 'bow wave' effect where at some point the steady state approach for asset renewal adopted by ENL to manage expenditure in line with predictable revenues may not keep up with the asset deterioration. To ensure the correct assets are targeted for renewal at the right time the process for condition assessments and selection need to be optimised.

The uncertainty associated with correct and informed decision making for network development, linked to changing regulatory control, safety and environmental protection requirements requires a high level of understanding of industry direction going forward. Past systems used in a stable environment with a lower rate of change are no longer adequate and increased involvement in the industry policy making arena is becoming increasing necessary.

8.4 Improvement Implementation

ENL has identified the following contributors affecting the ability to improve in these areas...

- Re-sourcing and maintaining the necessary skills and skill balance for internal staffing, external consulting and local contracting resources
- Provision of sufficient and suitable resource to ensure accurate and timely information capture, used as inputs to the prediction and forecasting processes used for management of the assets.
- Correct use of appropriate and efficient technologies including tools and equipment to optimise asset construction, condition assessment and maintenance costs.
- The level of involvement within the local community and at the policy making level.

With a decline in available resources becoming apparent and more significant in the local region ENL is actively contributing to training and development of new resource at the entry level to ensure improvement in the long term.

ENL has a technology focus and is active in identification and development of equipment and systems designed to offset the short term re-sourcing short fall.

Membership, strategic partnership and alliances are being developed in the short to medium term to improve ENL's understanding and input into the direction of the industry.

A1. Feeder loadings

Feeder loadings since 1 April 2000 are shown below. Note some zone substations require more than one chart.

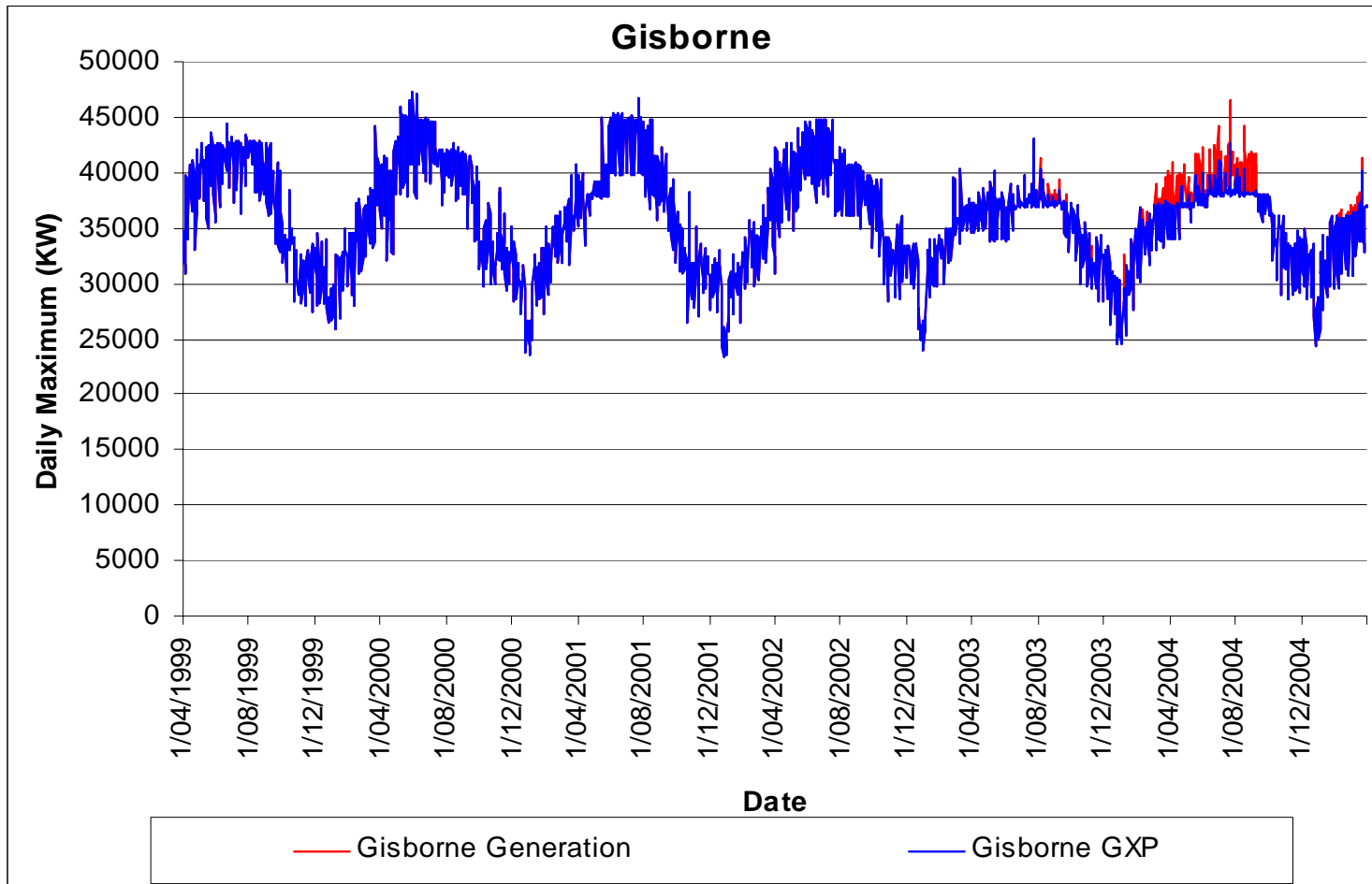

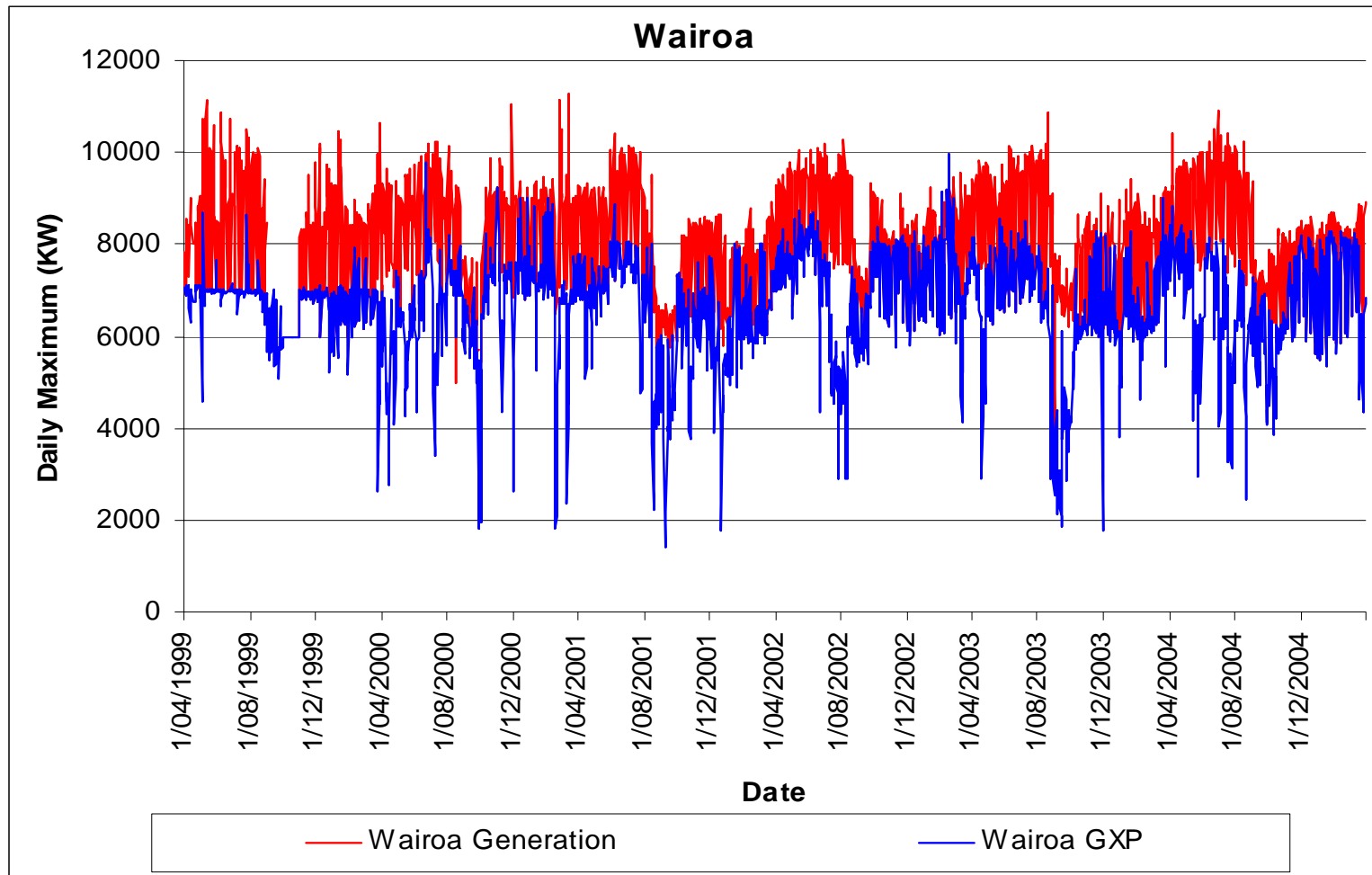

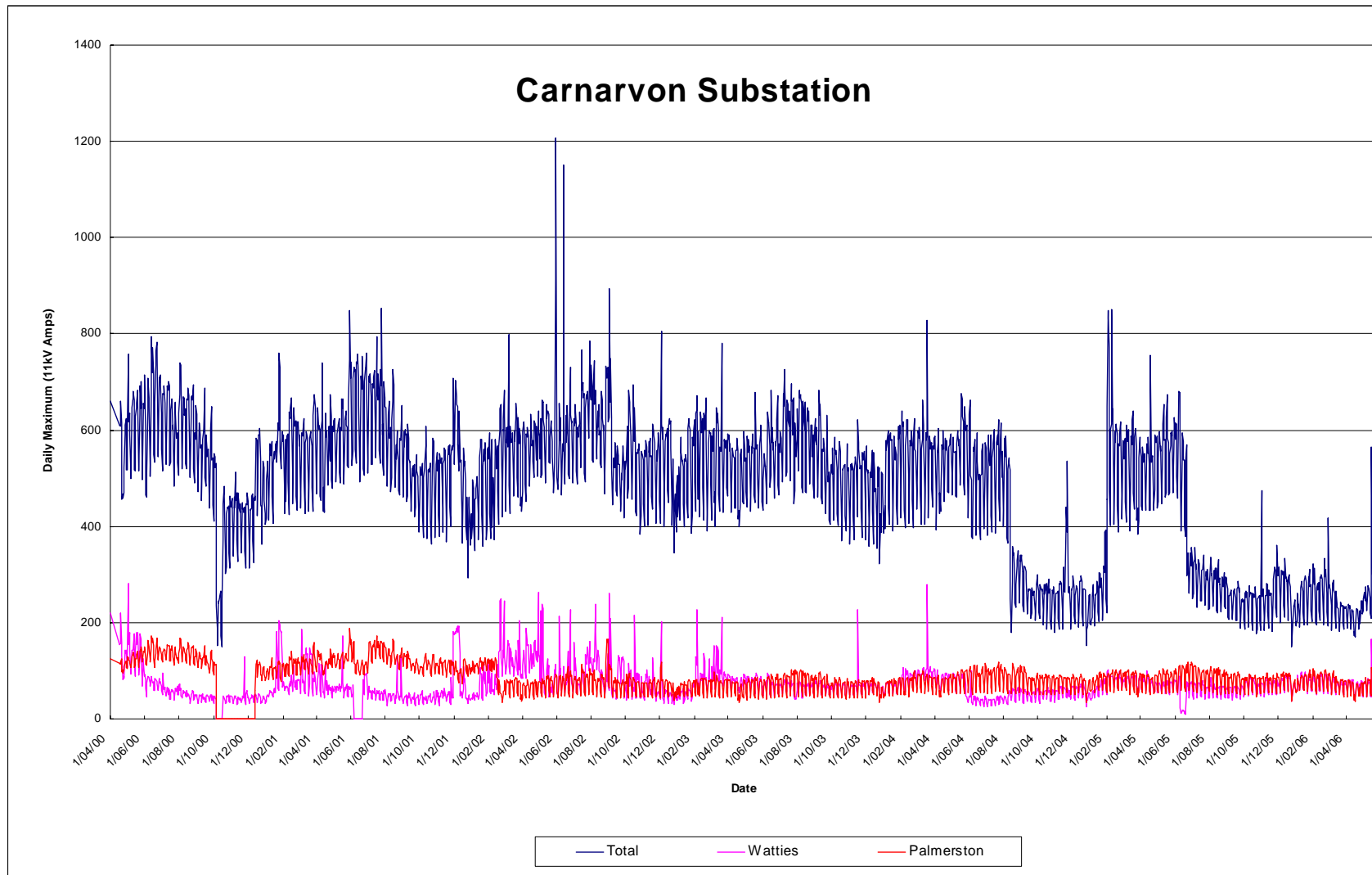

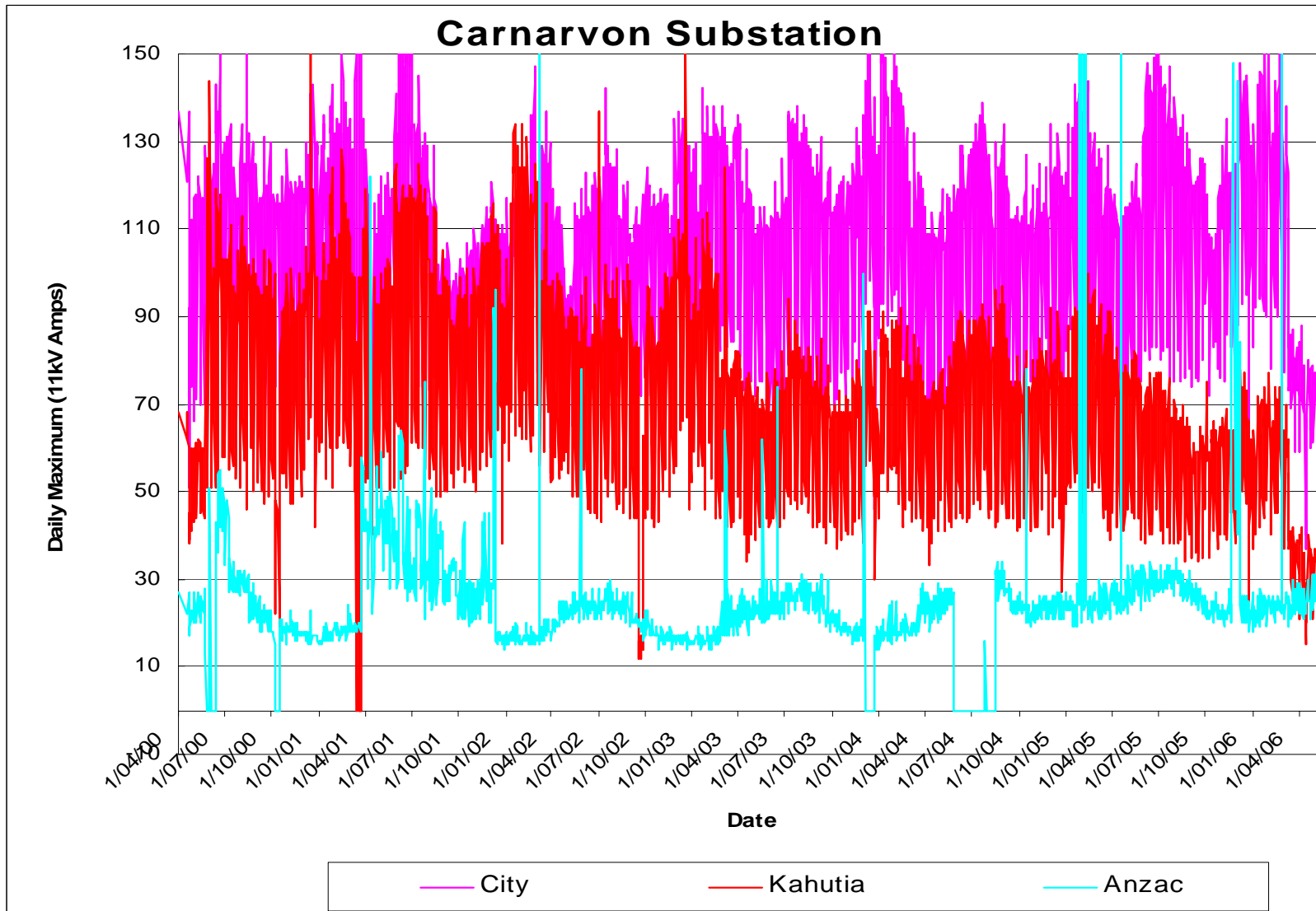

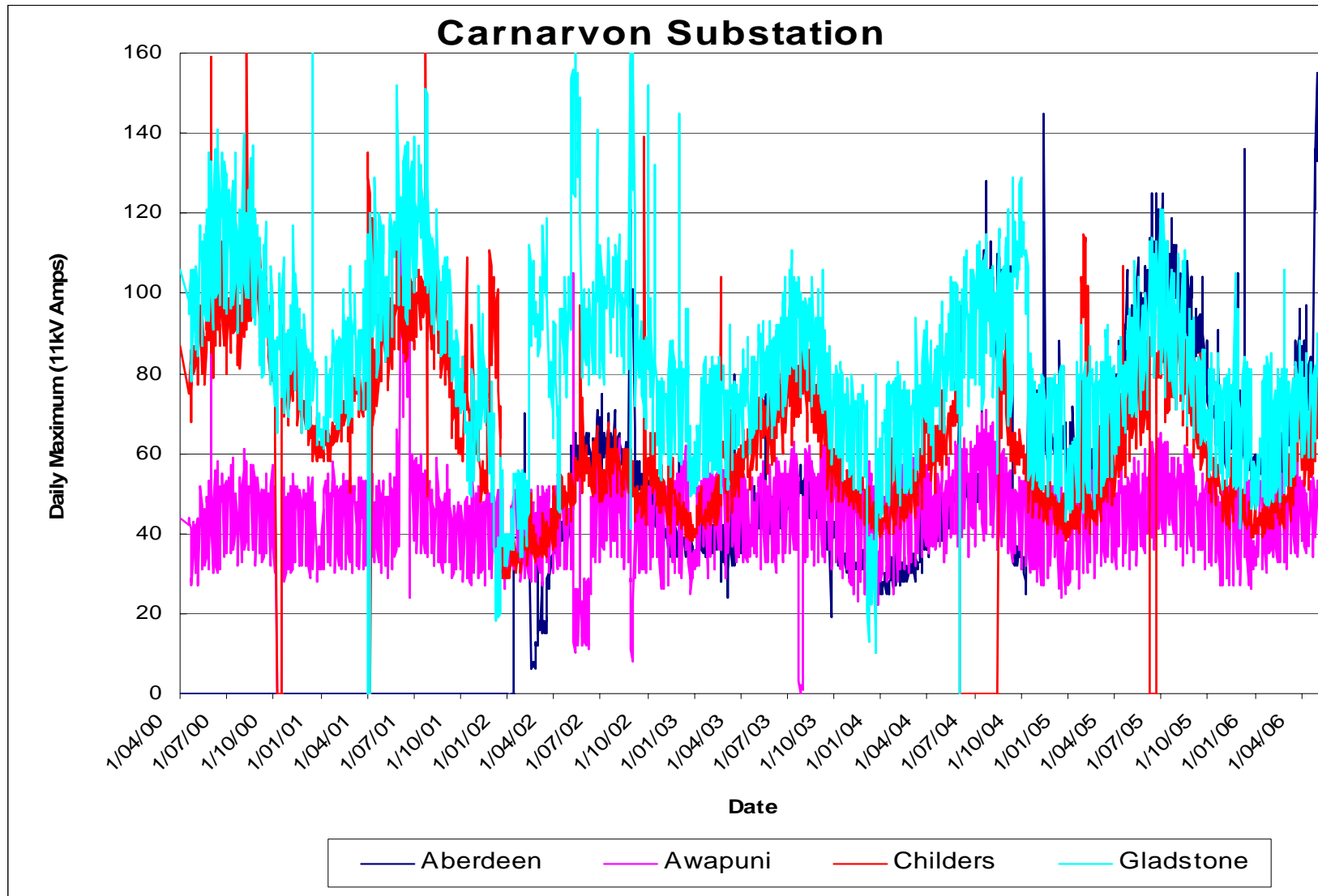

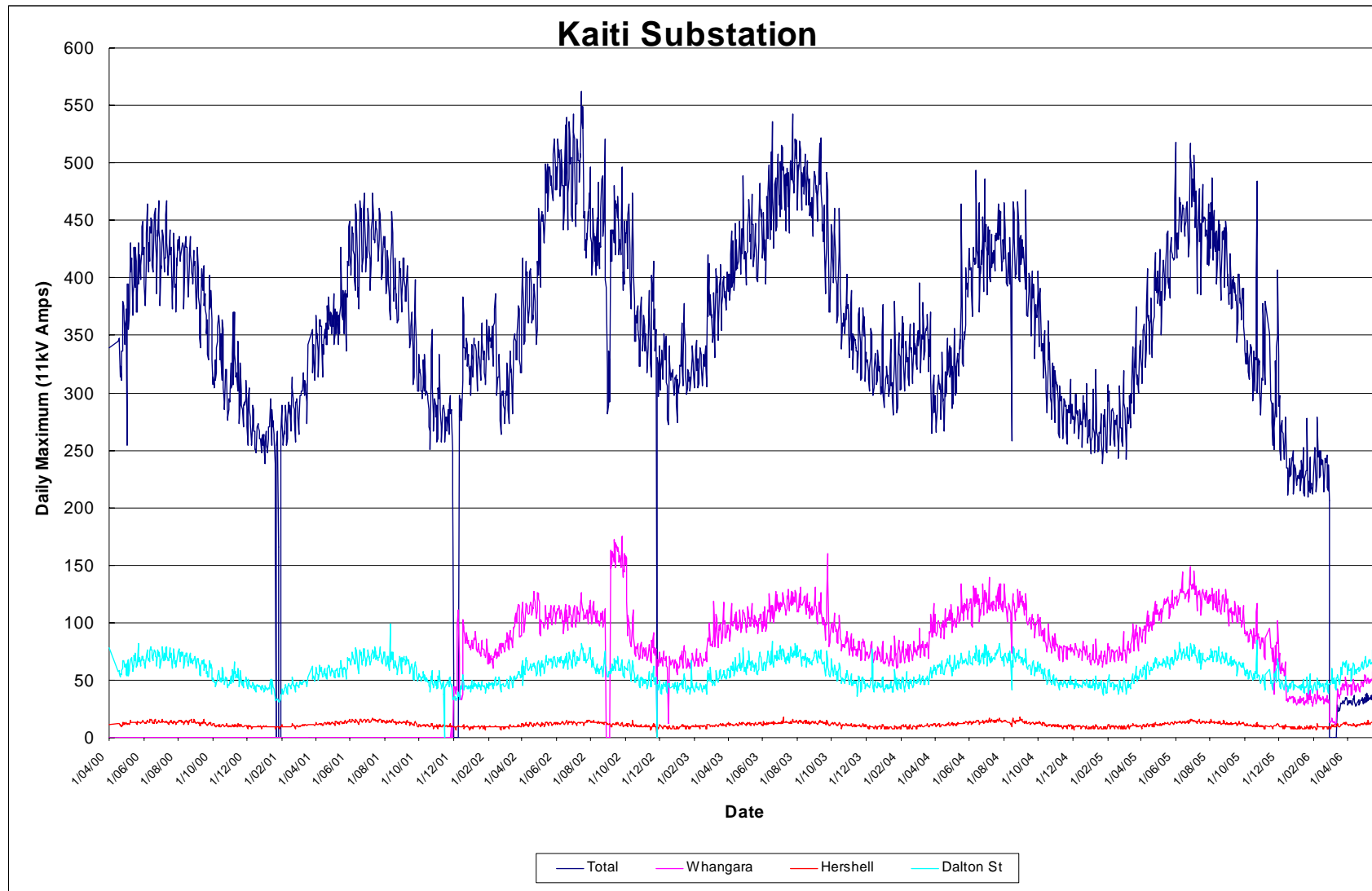

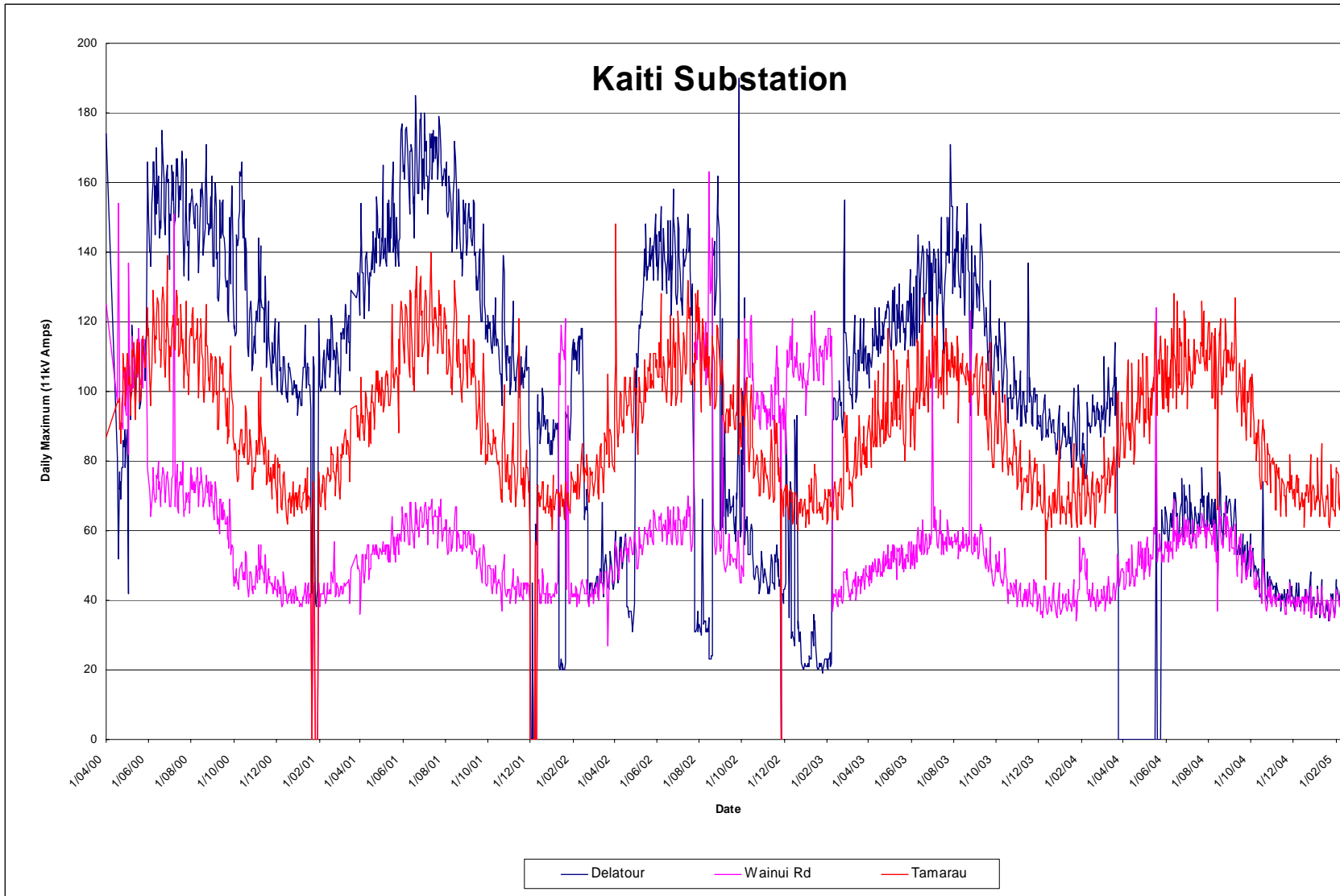

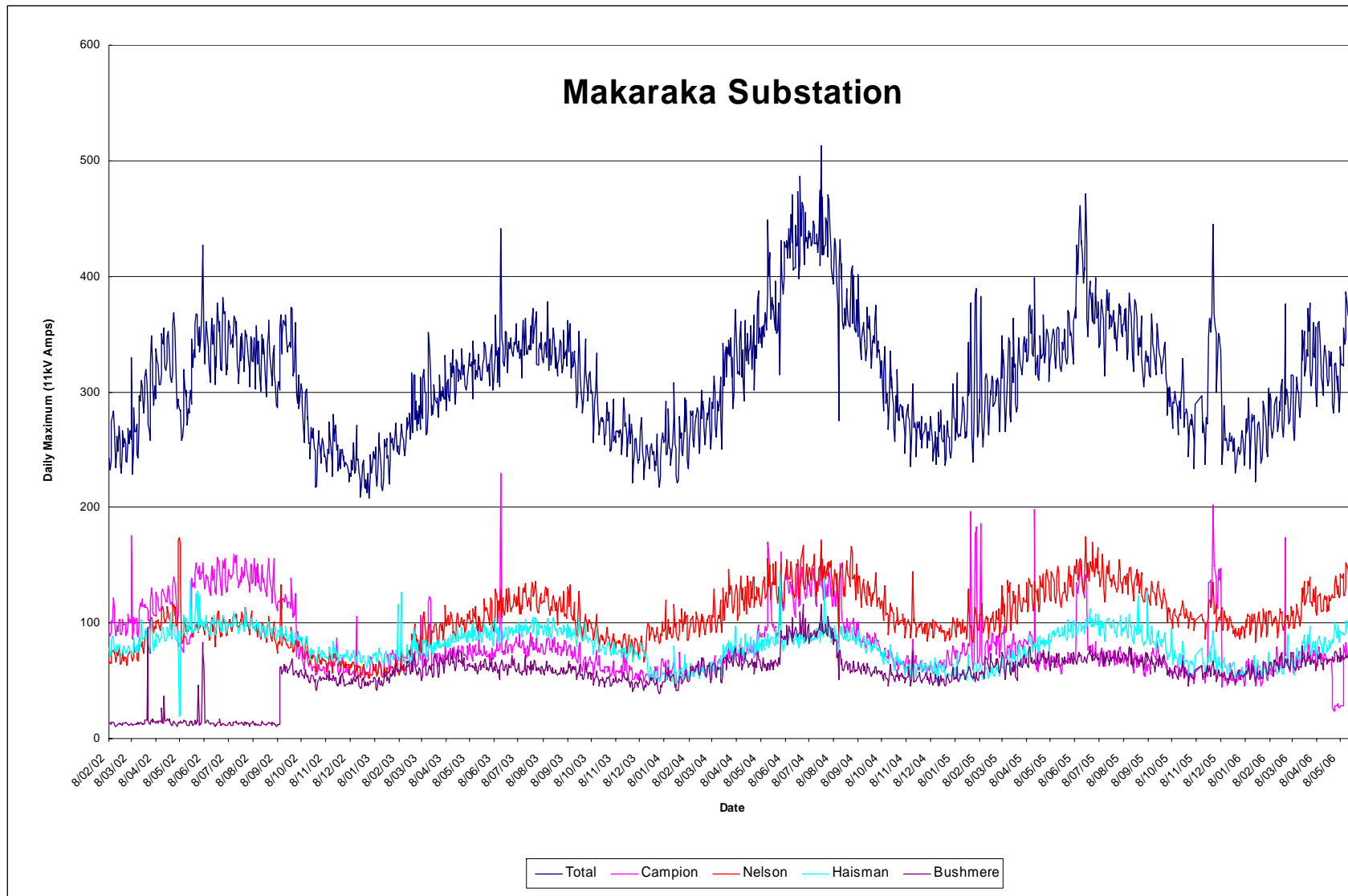

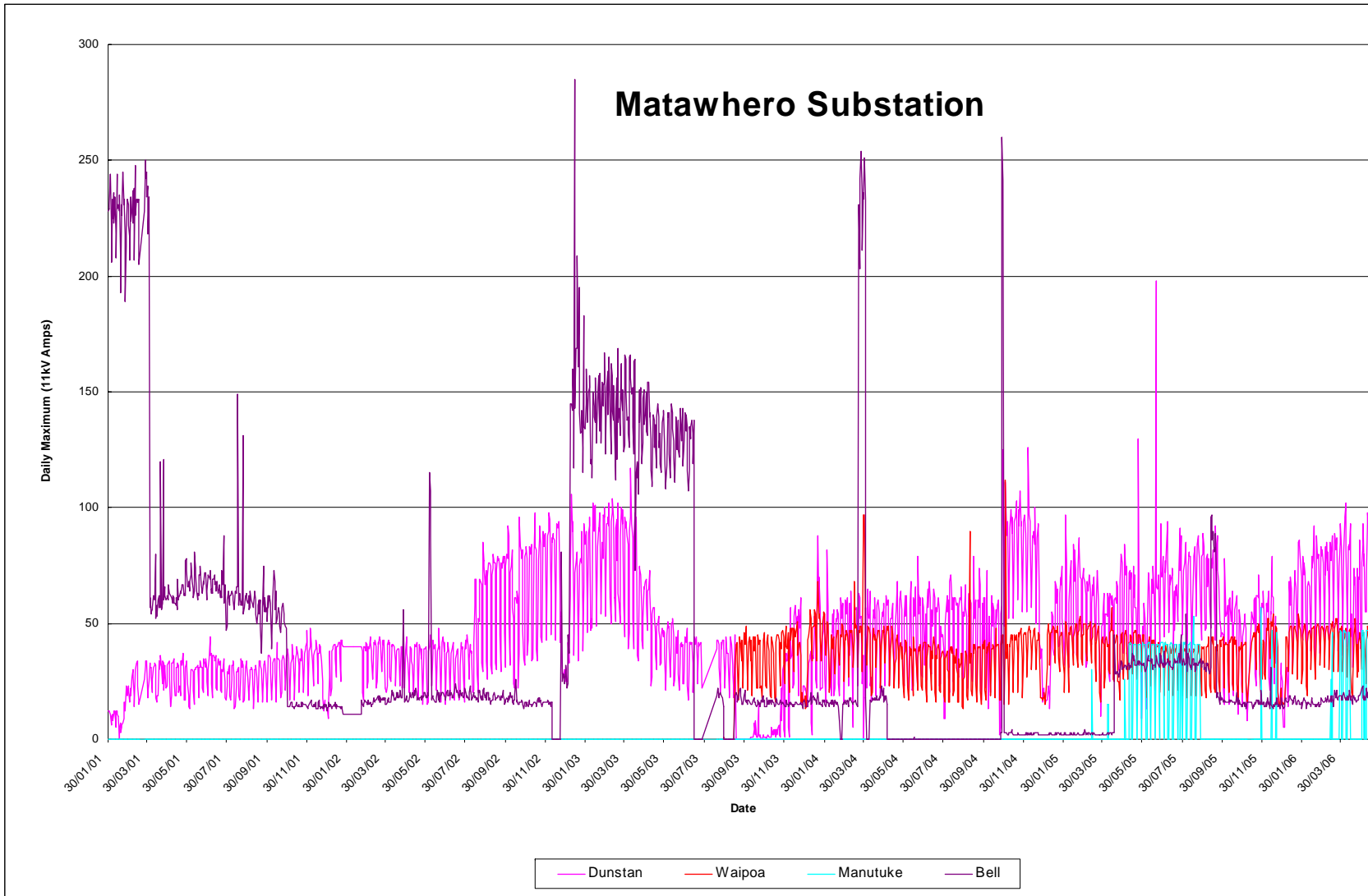

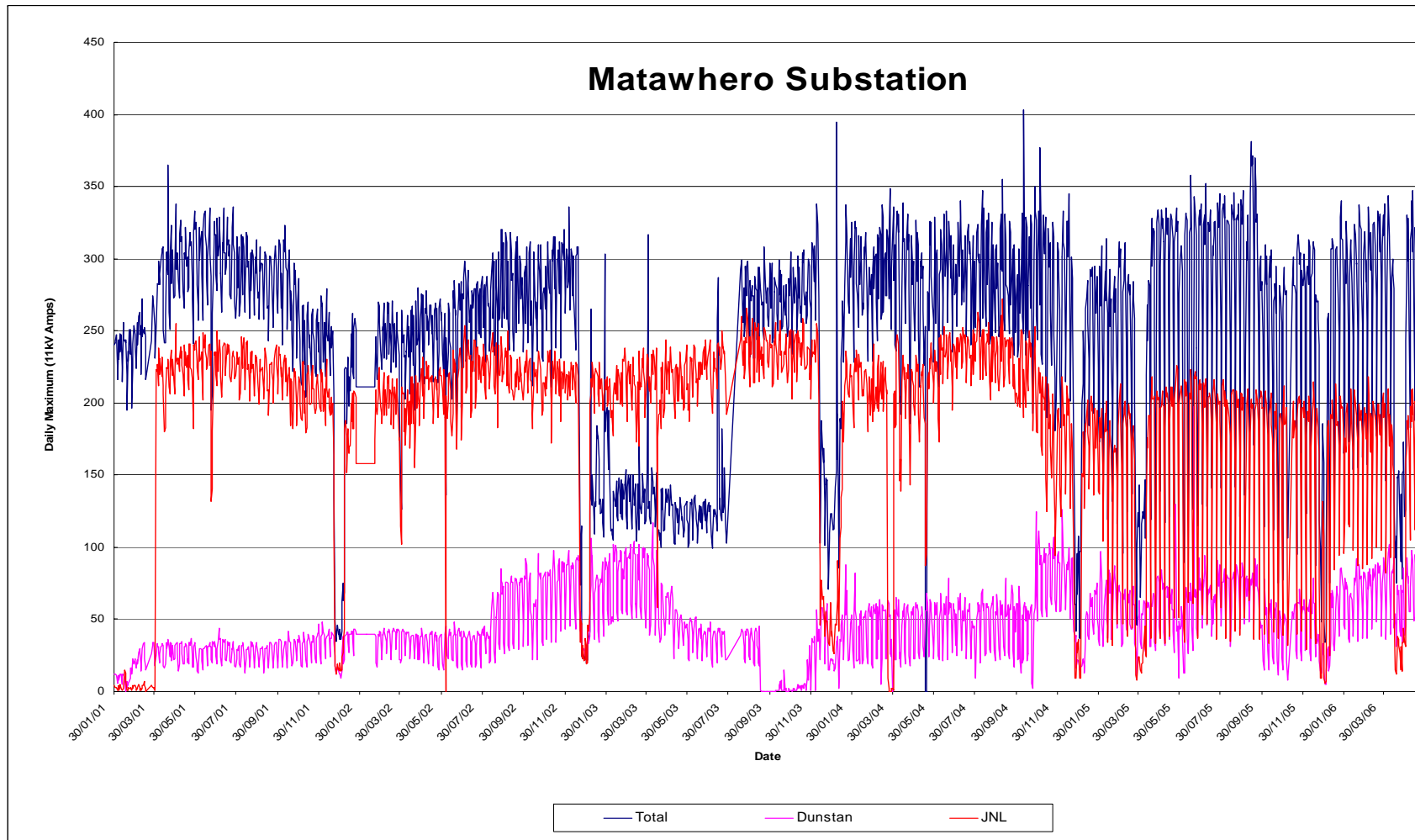

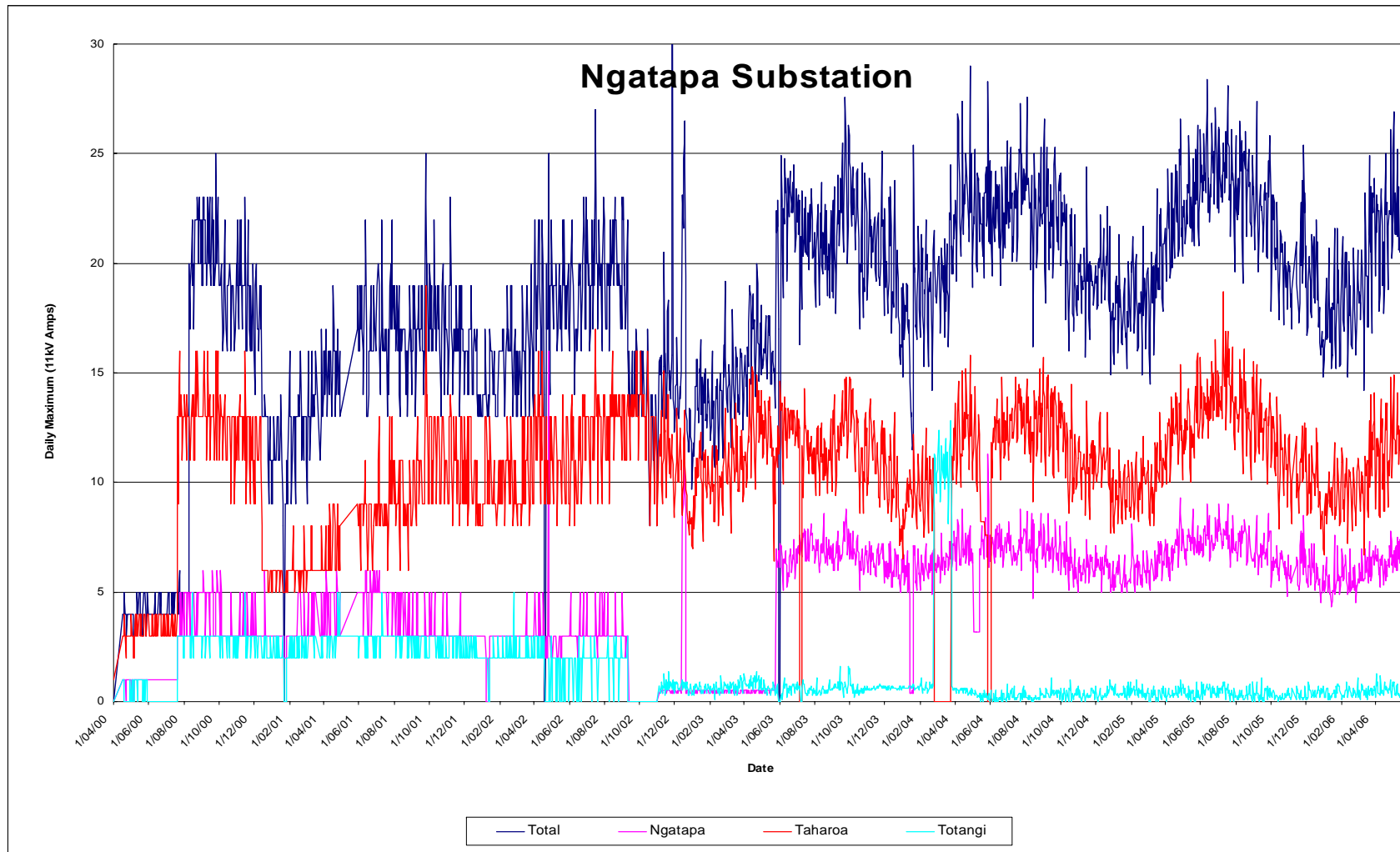

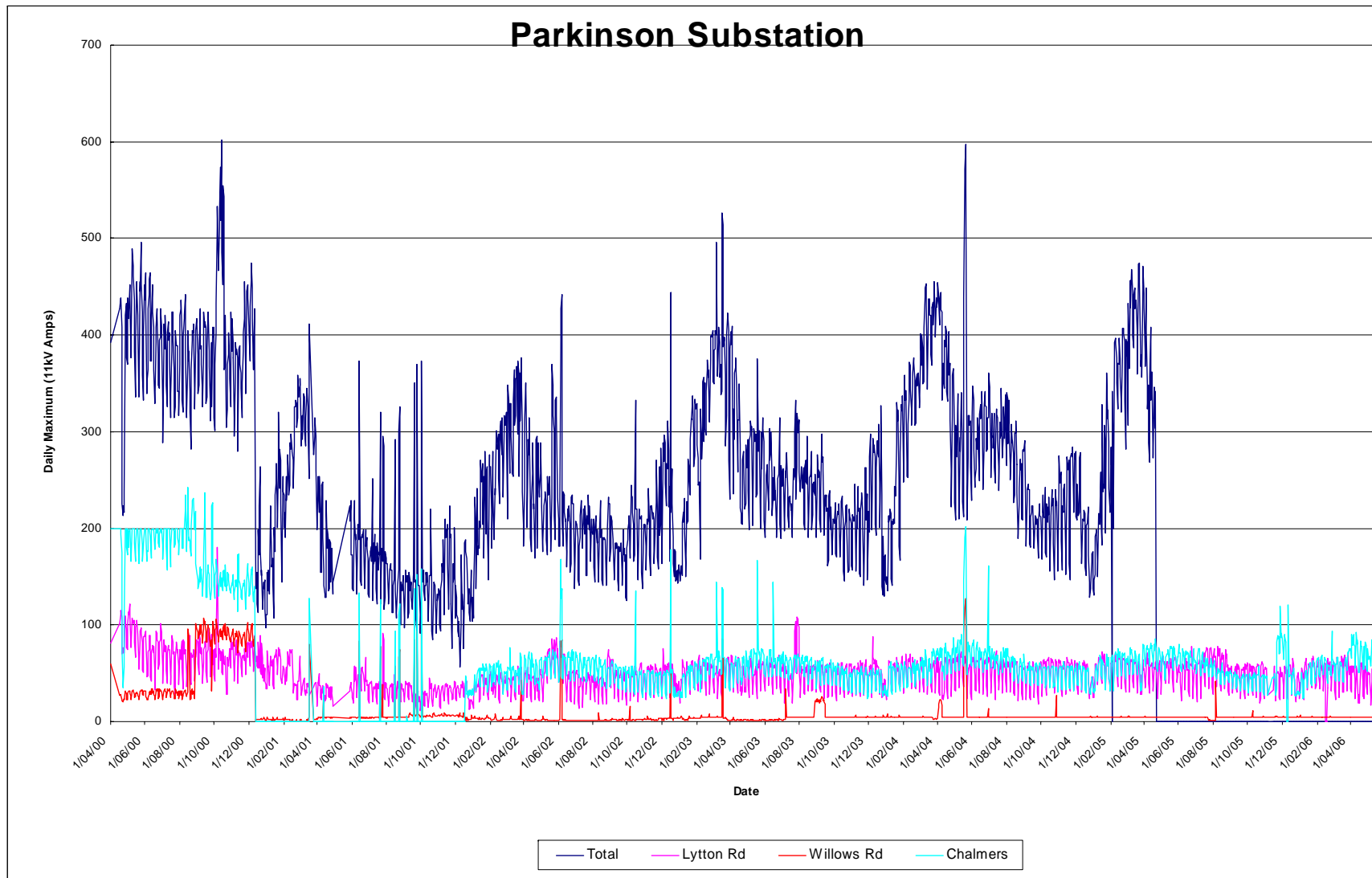

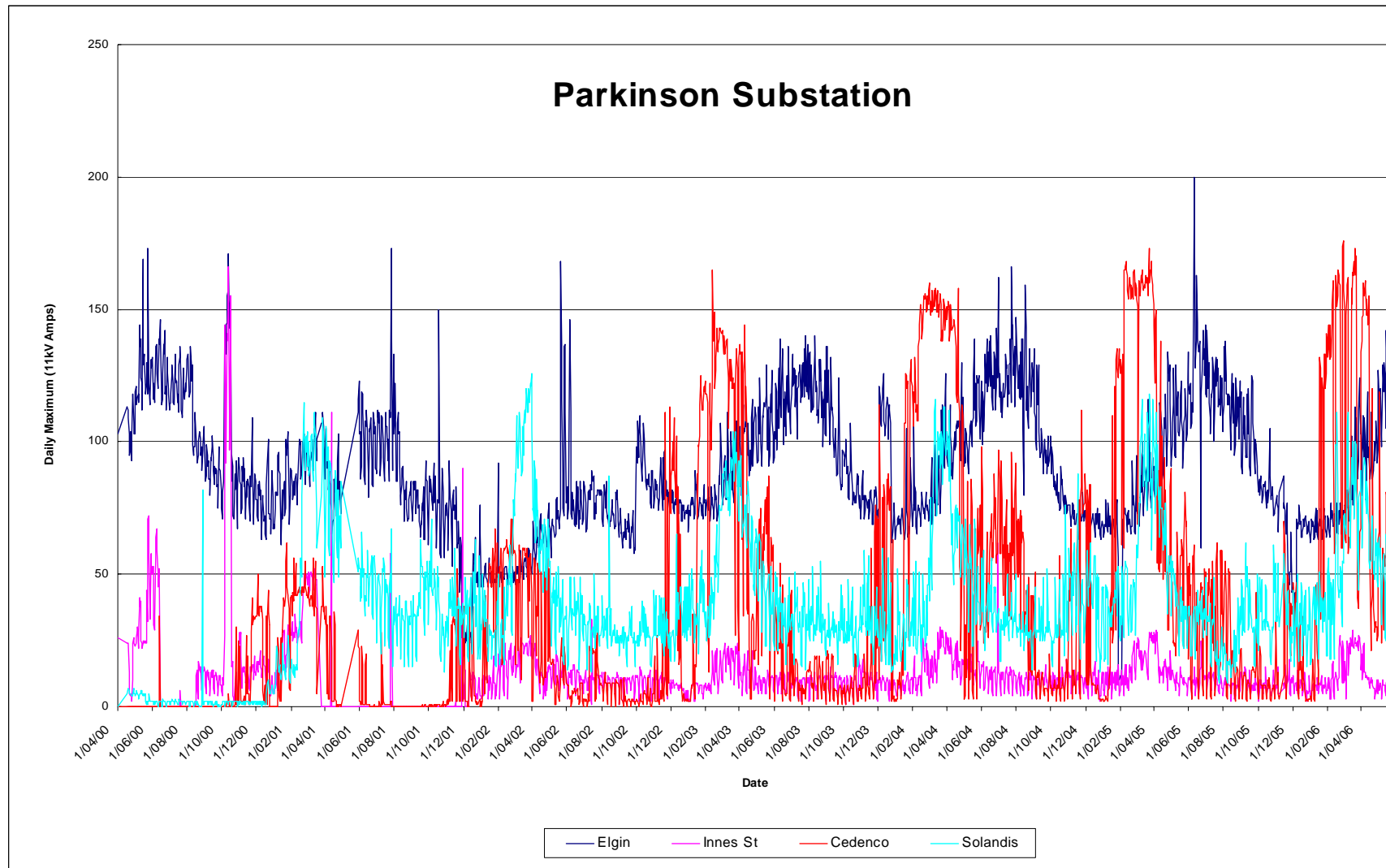

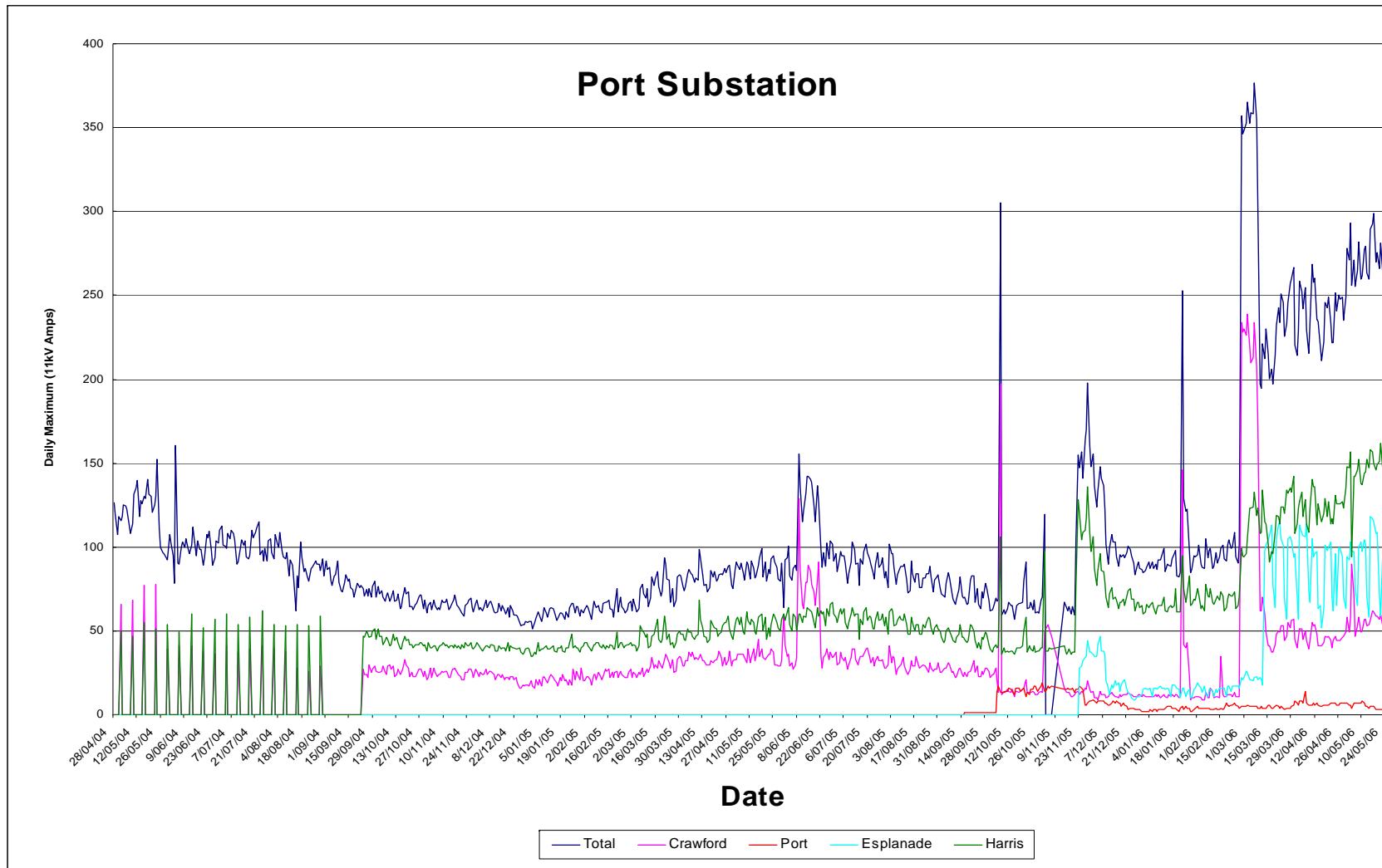

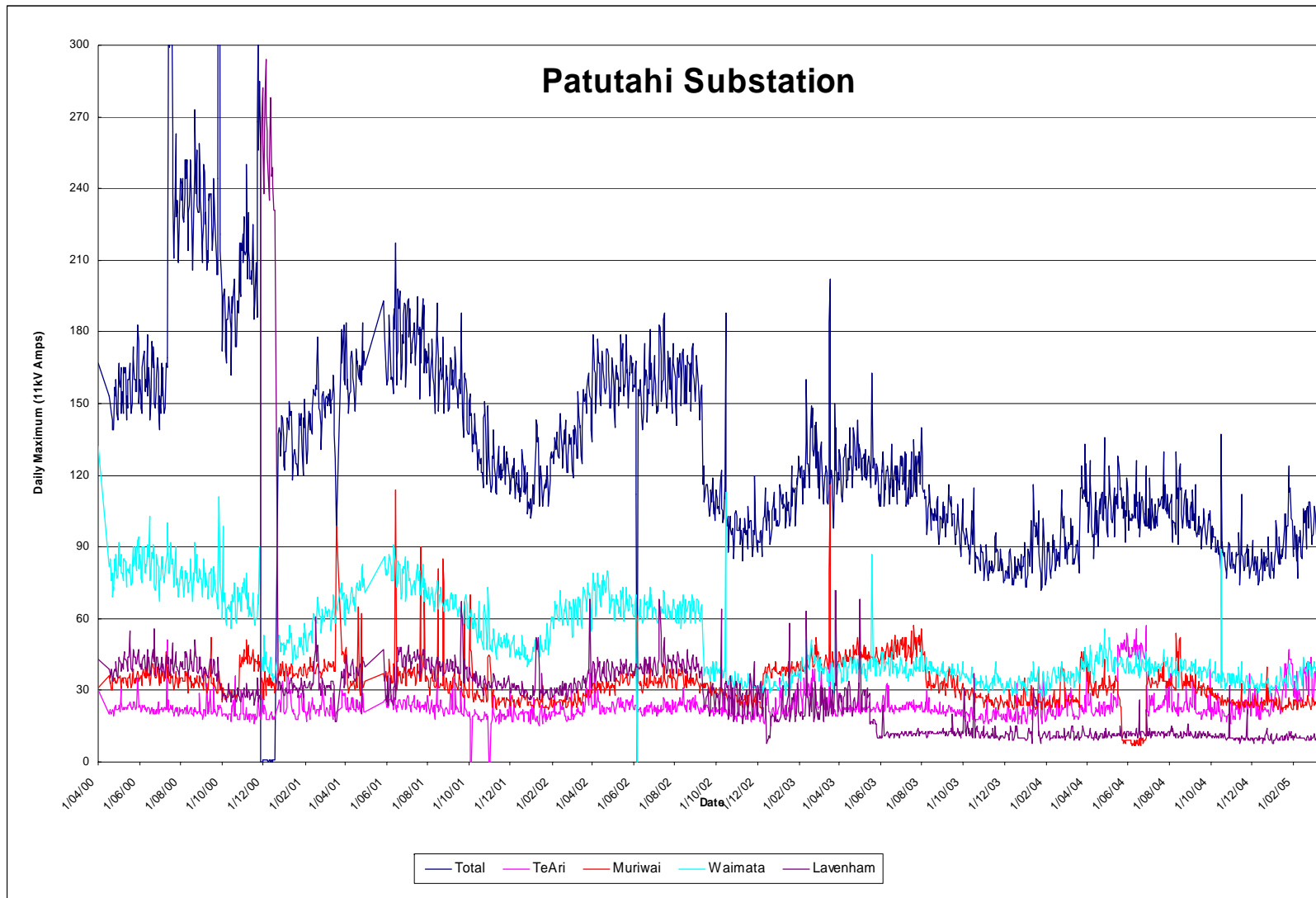

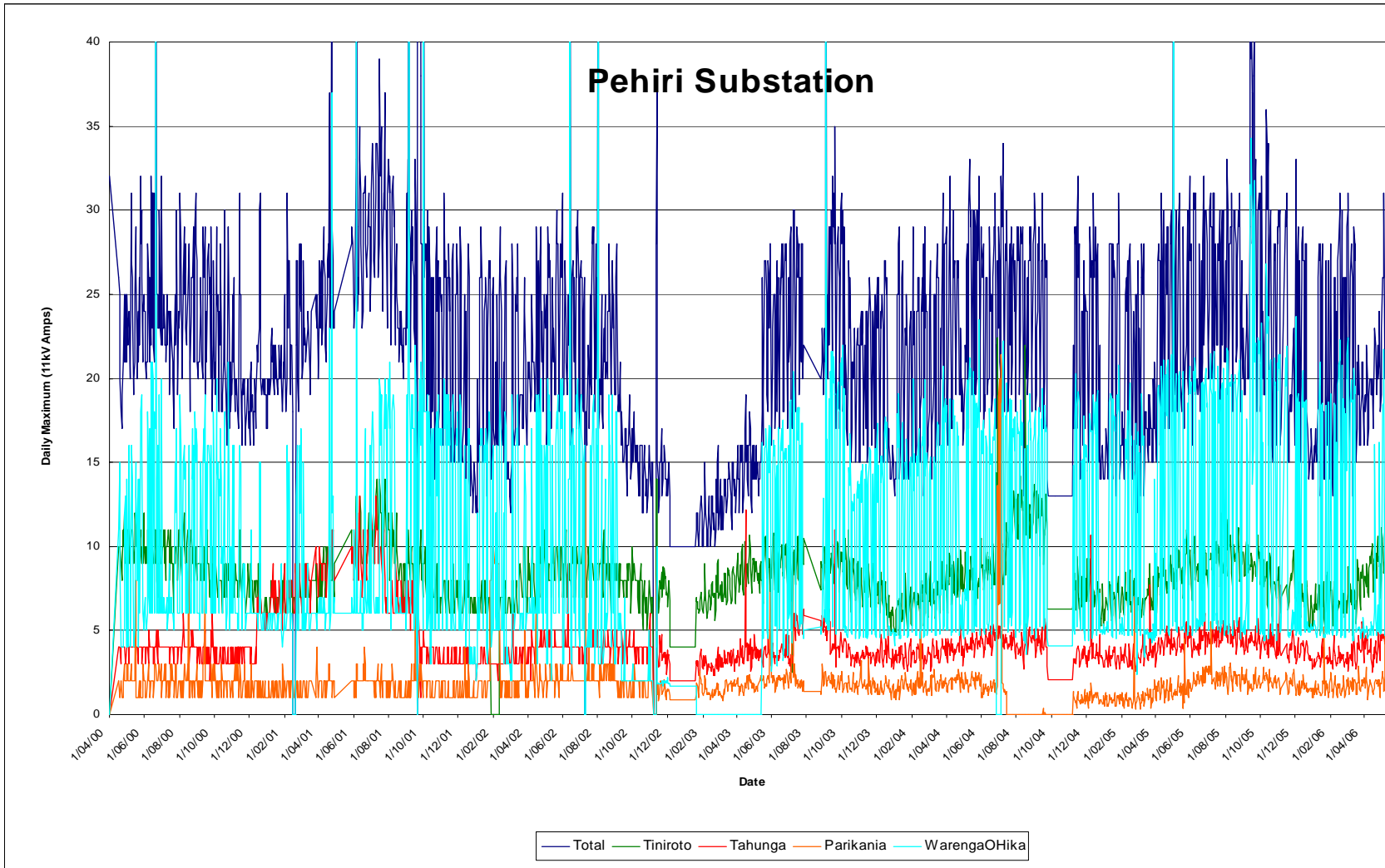

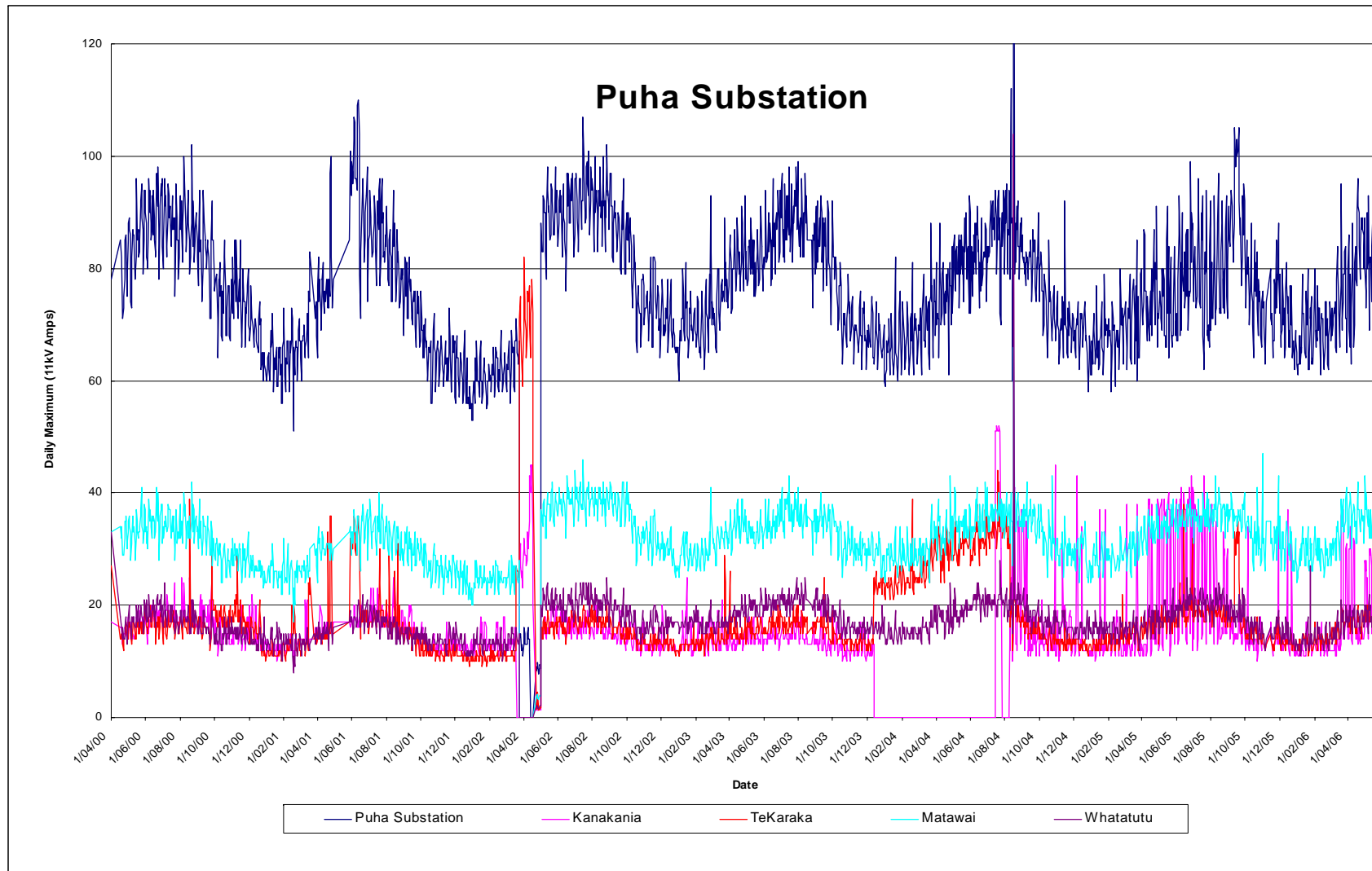

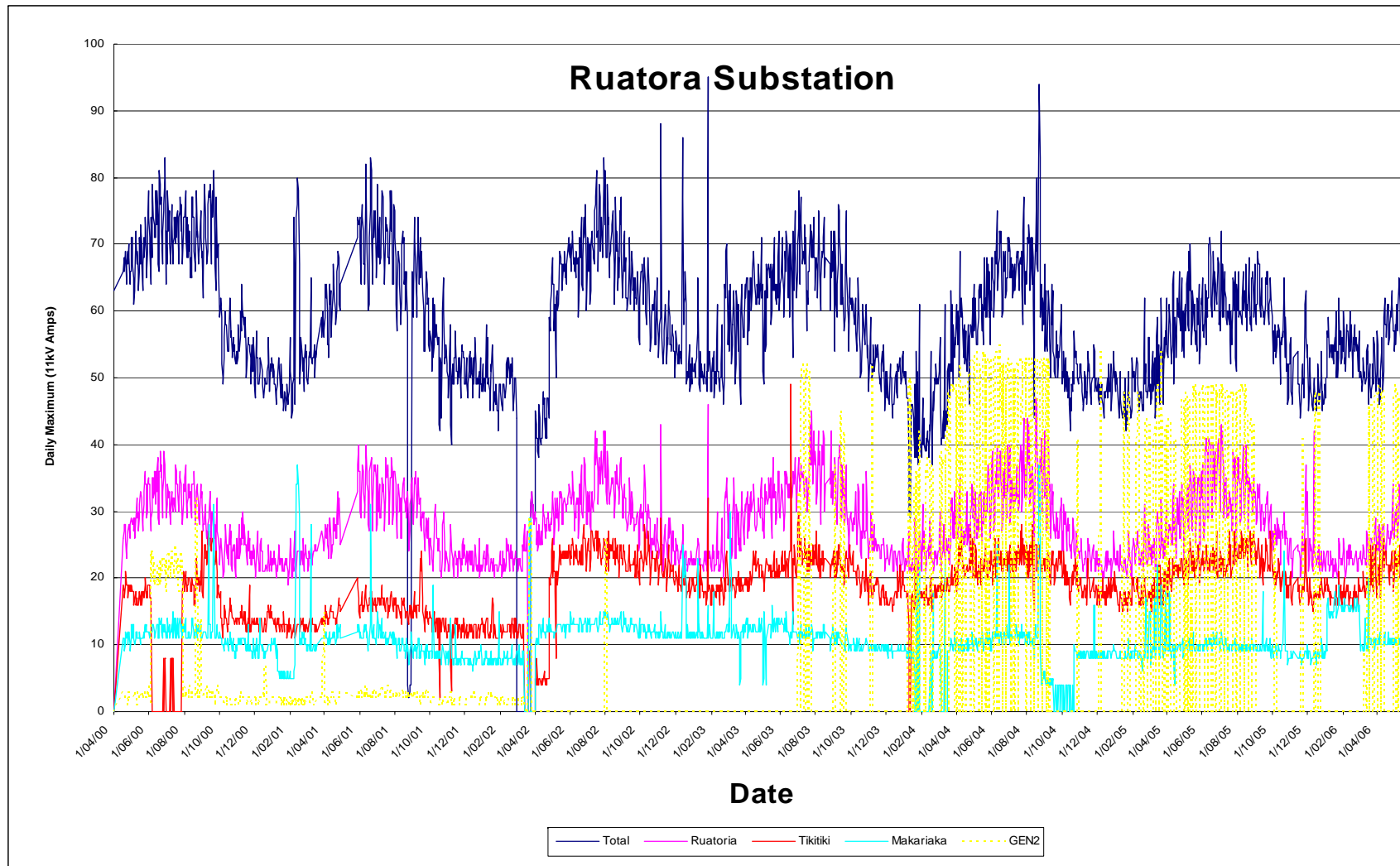

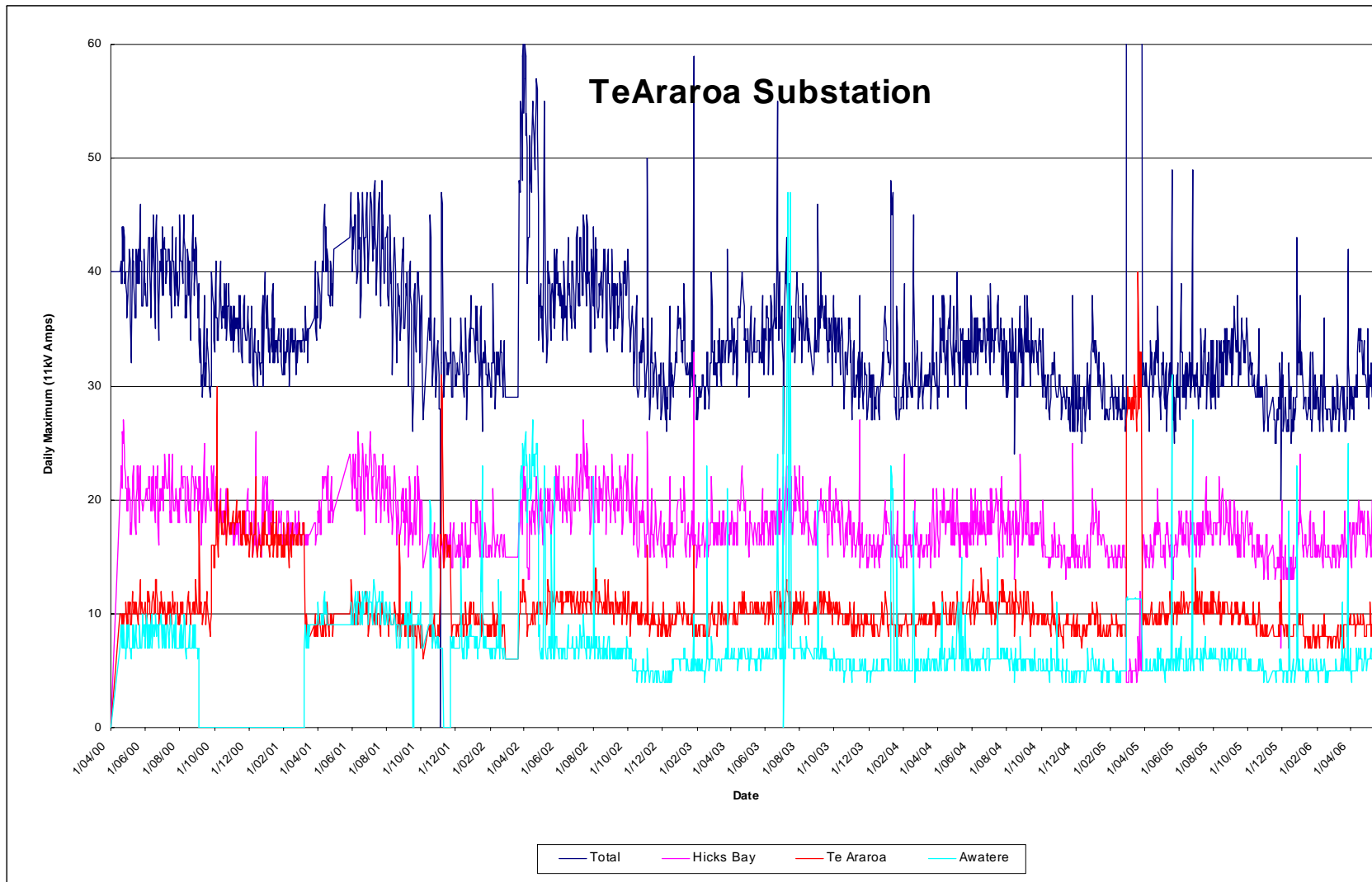

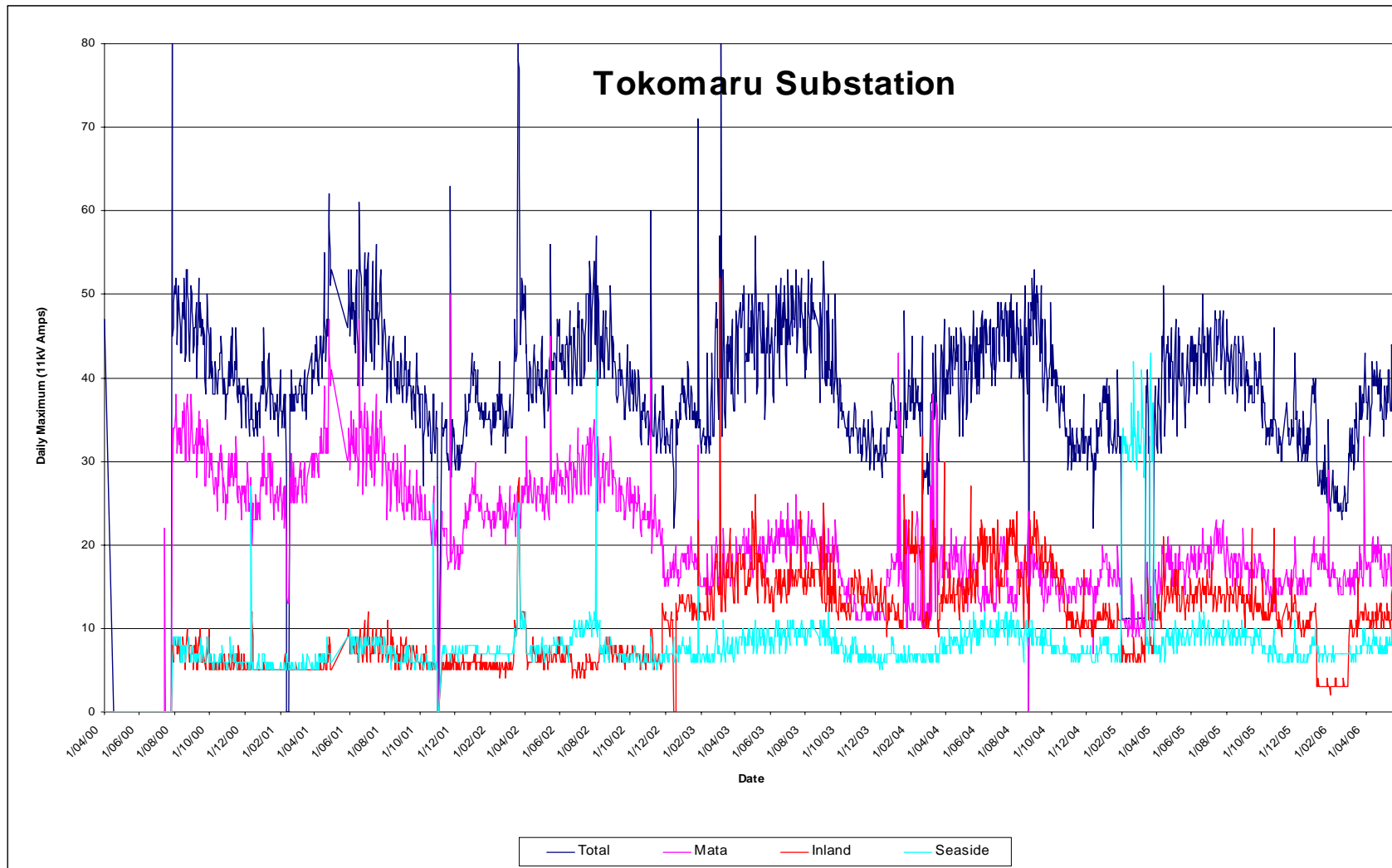

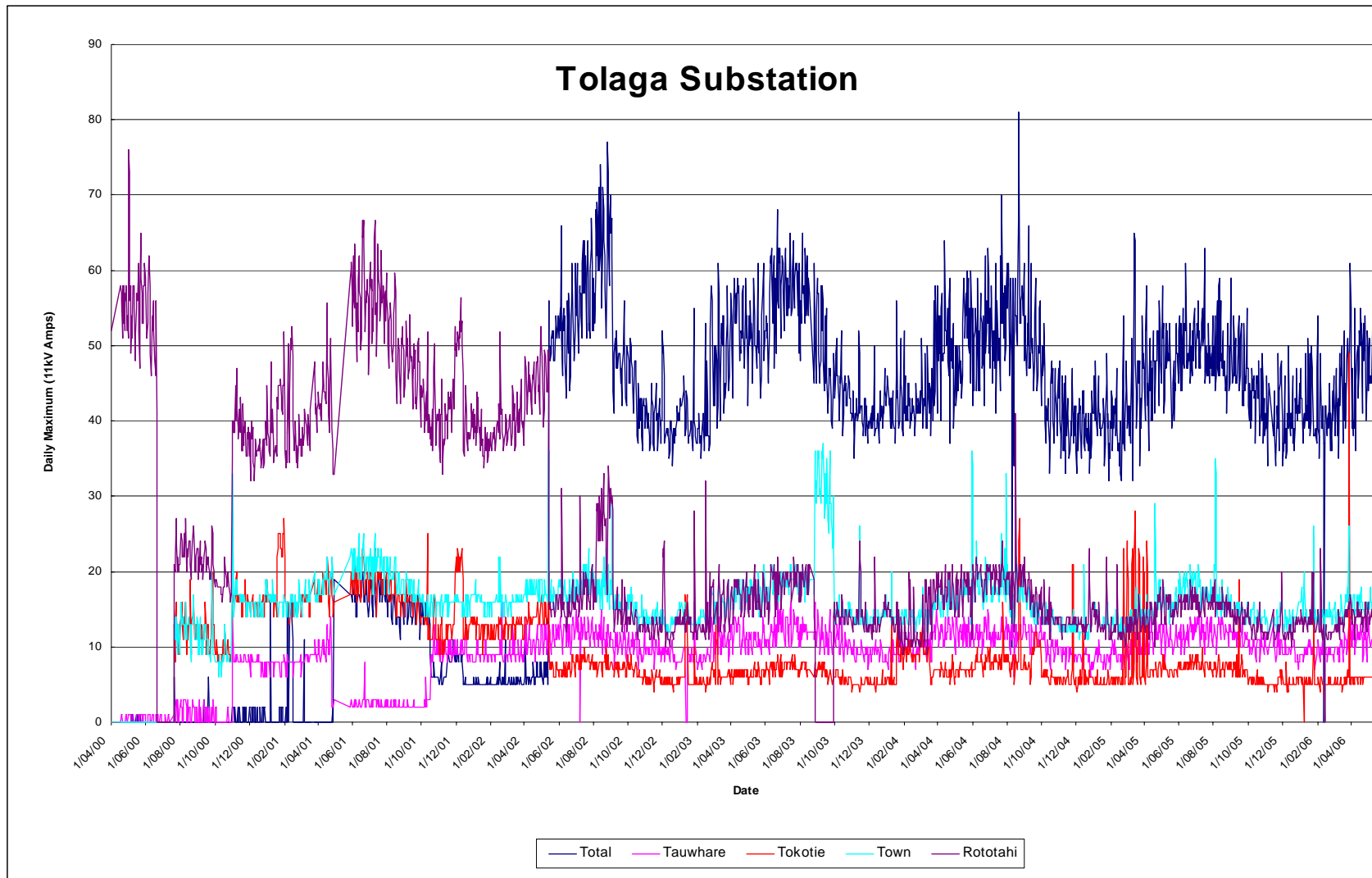

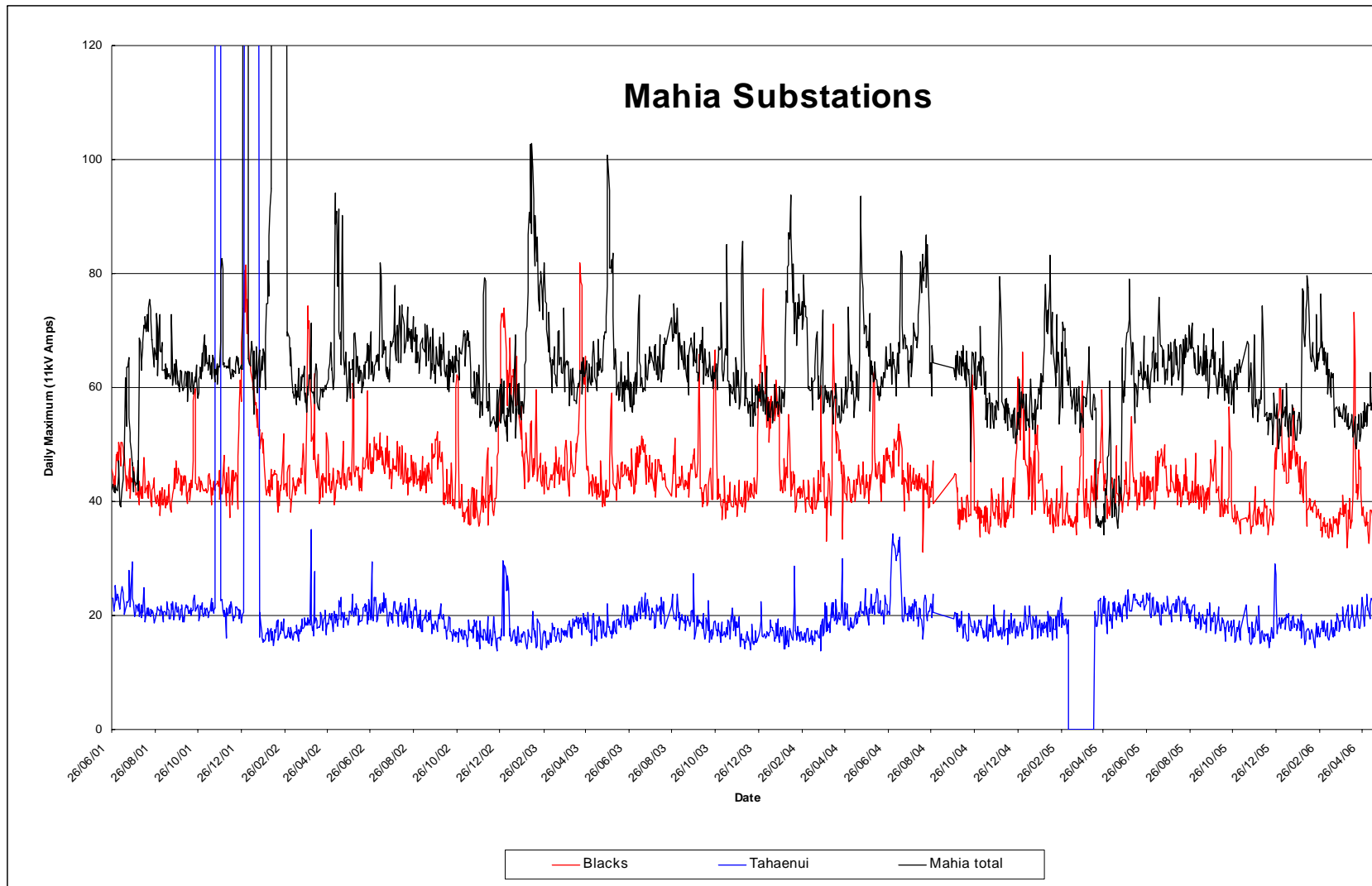

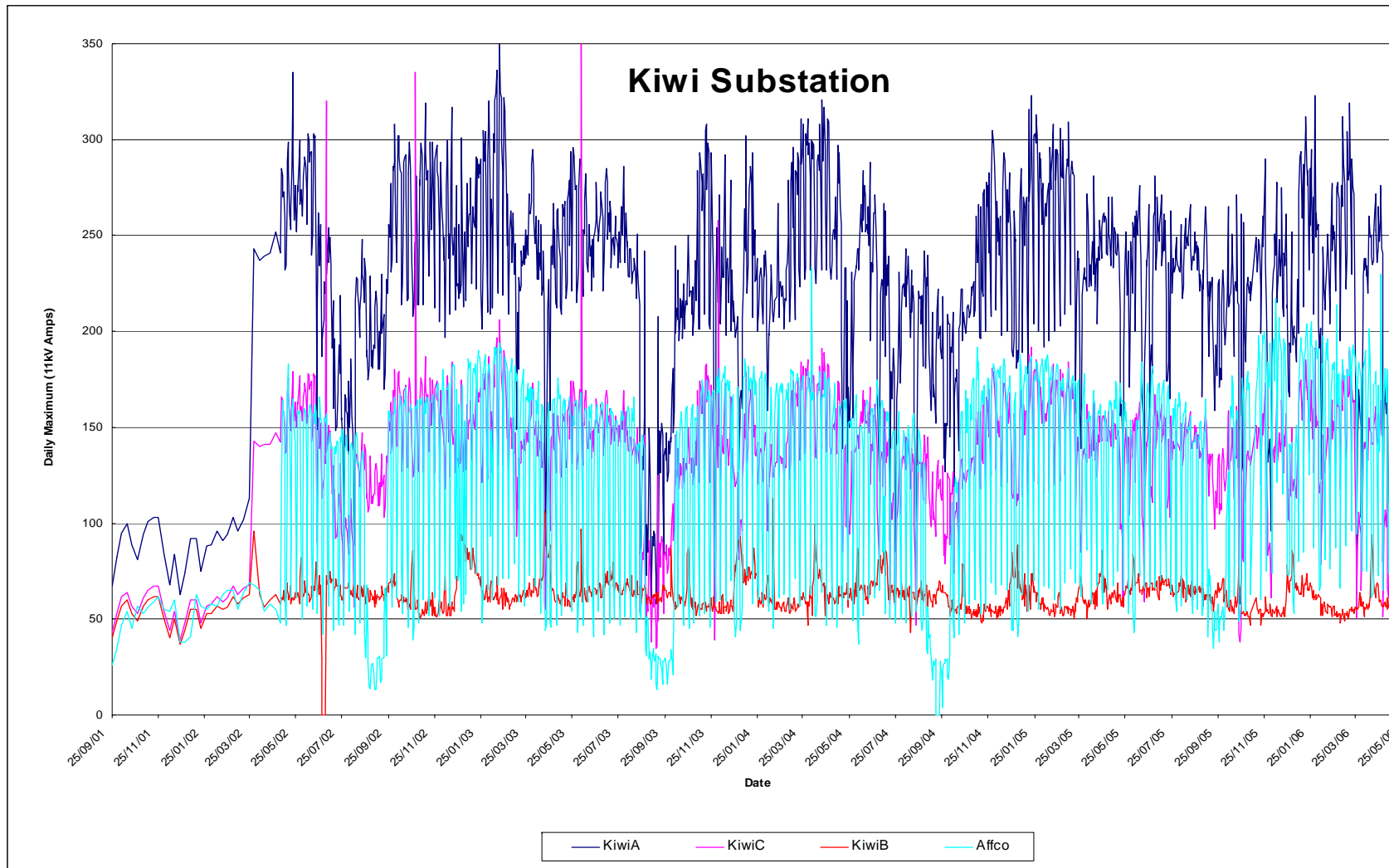

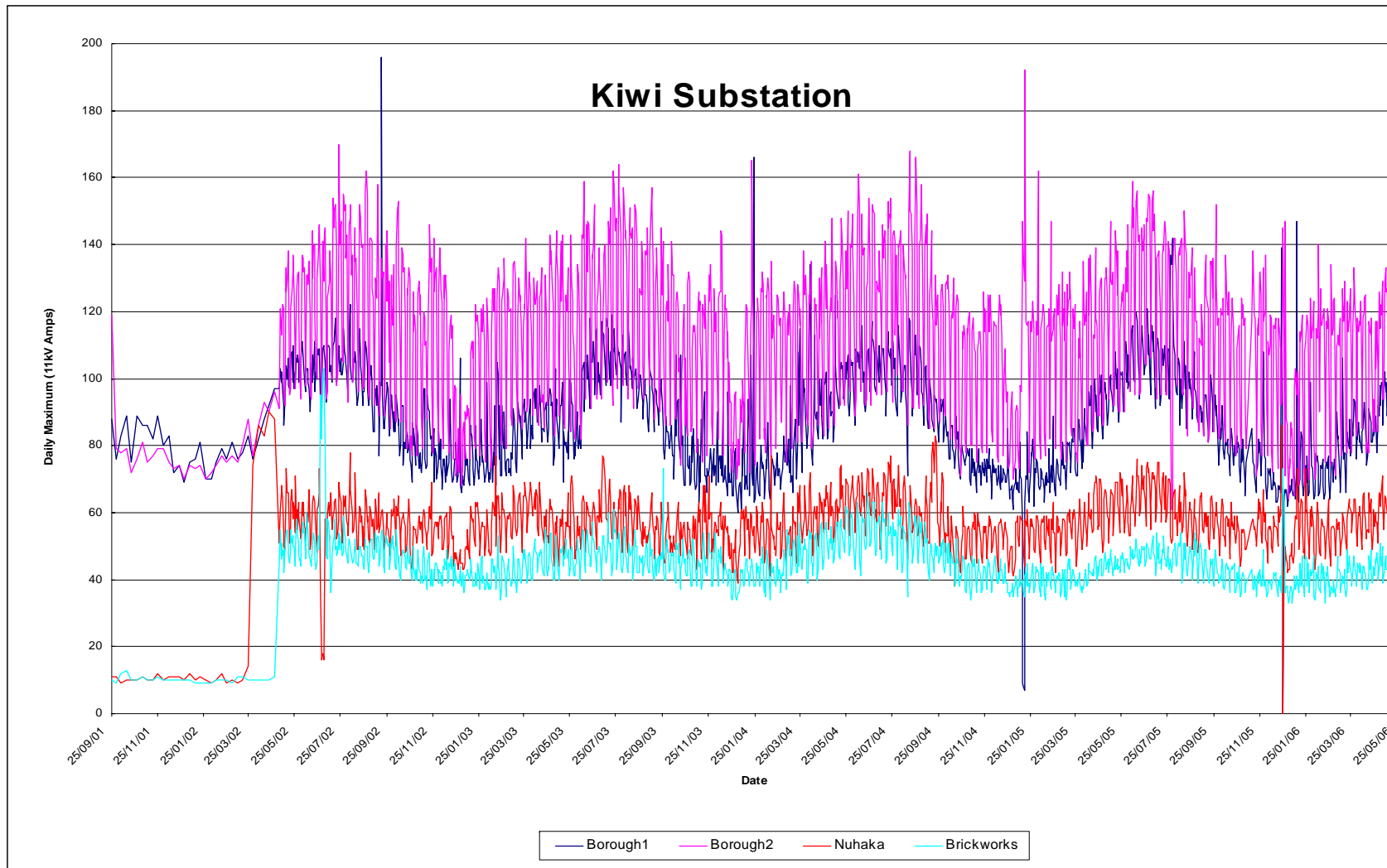

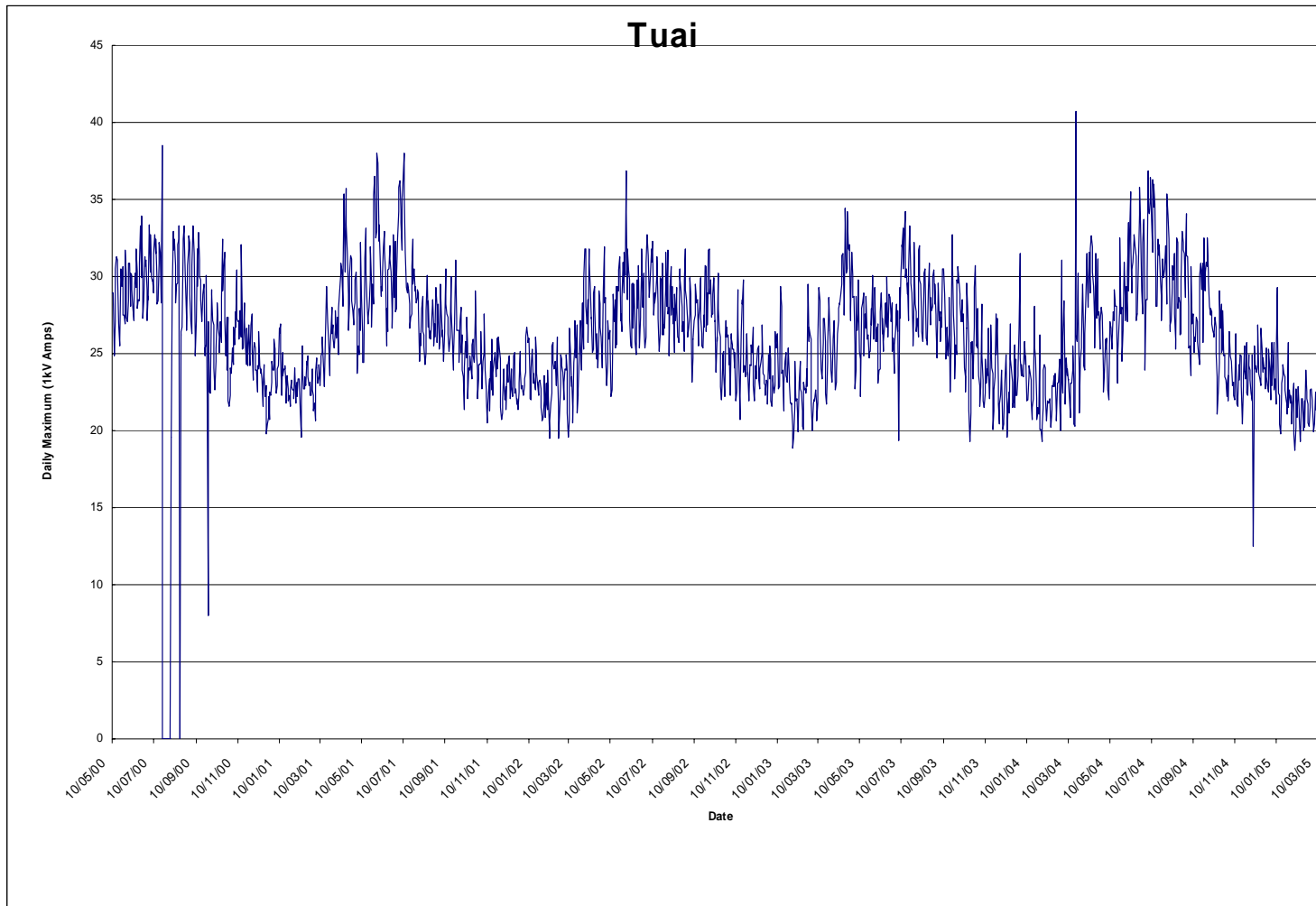

A2. Director certification

STATUTORY DECLARATION IN RESPECT OF STATEMENTS AND
INFORMATION SUPPLIED TO COMMERCE COMMISSION

Eastland Network Limited Asset Management Plan, for the Period 2006 - 2016

I, William John Clarke, of Gisborne, being a Director of **Eastland Network Limited**, solemnly and sincerely declare that having made all reasonable enquiry, to the best of my knowledge, the information attached to this declaration is a true copy of information made available to the public by **Eastland Network Limited** under the Commerce Commission's Electricity Information Disclosure Requirements 2004.

And I make this solemn declaration conscientiously believing the same to be true and by virtue of the Oaths and Declarations Act 1957.

Declared at GISBORNE this 30th day of August 2006.

William John Clarke

Solicitor

KRIS CLAPHAM
SOLICITOR
GISBORNE