

# **Asset Management Plan 2012 - 2022**



**1 April 2012**

# **Summary of ENL's AMP**

## **Purpose of the AMP**

This Asset Management Plan ("AMP") has been prepared to meet regulatory compliance requirements, demonstrate responsible asset stewardship, integrate stakeholder views, and communicate and justify network management practice and expenditure to Eastland Network Limited ("ENL") stakeholders. Presentation of the AMP in this format also meets the requirement 24 of the Electricity Distribution (Information Disclosure) Requirements 31 October 2008 and subsequent amendments.

Primary stakeholders include ENL's shareholder and customers, including retailers, generators and end-use electricity consumers. Other parties with an interest in ENL's asset management include contractors who physically work on the system and regulatory agencies.

Many factors impact on the effective long term management of a complex network of electricity assets, the life of which exceeds the tenure of the Managers responsible for them and whose operating environment introduces significant investment risks. For this reason, the overall scope of the AMP is wide, covering the regulatory environment, future service demands and technology development.

While making long term forecasts to provide sustainability and establish the framework for ENL's future, the AMP primarily drives work programs in the short to medium term. It is in all respects a living document. The practices and processes described are subject to continuous improvement, and detailed work programs are progressively refined throughout the year. The Eastland Group asset management team is the "owner" of this AMP.

## **Completion date & planning period**

Preparation of the AMP was undertaken between November 2011 and March 2012. The ten year planning period considered is from 01 April 2012 to 31 March 2022. The plan documents how ENL ensures long lived network assets are being managed in a sustainable way over their lifecycle within defined boundaries of Shareholder returns, Regulatory requirements for performance and revenues, Customer expectations and Regulatory requirements for Safety and Quality.

The ENL Board of Directors approved the AMP for disclosure on 23 March 2012.

The next revision of the AMP, (covering the period 2013 to 2023) will be prepared for disclosure on 1 April 2013.

## **AM systems & information**

A quality management system is used to provide policy and procedures covering, Health and Safety, Public Health and Safety, Risk Management, Design Standards, Project Management and Emergency Management.

Asset information covering physical attributes, condition and performance is stored in Databases associated with the GIS system. Standalone systems provide Work management and financial management capabilities.

A SCADA system (Supervisory Control and Data Acquisition) provides real time data, trending information and enables remote control of key components of the network. This data and network modelling software are used to analyse the network and assess the impact of changes in utilisation and operation.

Strategic Plans, Business Plans, Budget Processes and the asset management process set the programs for maintenance and asset development to ensure optimum customer service and operational efficiency within financial boundaries. This includes the recognition of the needs of customers that are willing to pay to have additional security and/or reliability of supply. Implicit in the asset planning process is an understanding and evaluation of the risks to operation and the consequences of failure. ENL is continually striving to find more efficient ways to carry out its activities, reducing costs and improving productivity, and maintaining safety levels.

The processes activities that form the core of asset management practice and decision making at ENL are regulatory requirement evaluation, condition assessment, reliability performance analysis, asset utilisation/capacity evaluation, risk management, economic optimisation, stakeholder feedback and benchmarking.

Management services only are provided by the Eastland Group to ENL. This includes fulfilling ENL's financial management, planning, design and network operating activities. Since all physical work on the network is contracted out, the network operating function includes significant responsibility for contractor management. In addition to applying commercial disciplines to project identification and justification, ENL negotiates competitive contracts for maintenance and capital projects. The need to train and continuously upgrade the skills of internal staff is recognised through improvement programs and specific training. In the case of contractors and suppliers, forward-looking commercial agreements encourage a partnering approach to skills development and productivity improvement.

## Asset description

The distribution network assets included within the scope of the AMP are indicated below together with quantities and the optimised depreciated replacement cost determined by the most recent valuation as at 31 March 2009.

Asset description	Quantity	Unit	Average age	Condition summary	ODRC	% of ODRC
Subtransmission line	335	km	29	Average	3556	2.75
Subtransmission Poles	2441	each	23	Average	9366	7.25
Subtransmission cable	2	km	6	Good	413	0.32
Other zone substation assets		total	9	New/good condition	6141	4.76
50/11kV and 33/11kV transformers	37	each	20	Average	5238	4.06
Distribution line	2411	Km	39	Condition Ageing	10925	8.46
Distribution Poles	24892	each	27	Condition Ageing	25945	20.09
Distribution cable	135	km	21	Above Average	10505	8.13
Voltage regulators	9	each		Average	438	0.34
Distribution Substations	3701	each	26	Average	5810	4.50
Distribution transformers	3509	each	24	Average	13166	10.19
Distribution Fuses	2856	each	26	Below Average	748	0.58
Distribution switchgear	1820	each	21	Above Average	12115	9.38
LV lines	540	Km	39	Ageing	5627	4.36
LV Poles	6550	each	28	Ageing	5073	3.93
LV cable	187	km	22	Average	9105	7.05
Communications		total	8	Technology determines Condition	758	0.59
SCADA & system control		total	6	Technology determines Condition	582	0.45
Connection assets	25421	each	26	Customer Drives upgrades	3636	2.82
<b>Total</b>			<b>24</b>		<b>129147</b>	

The System Fixed Assets Replacement Cost Roll-Forward Report, (AV3) completed as part of Information Disclosure, which is based on asset additions and removals since the ODV valuation in 2004 of \$86.299m, determined the disclosed 2011 valuation as \$117.405 million. This is an overall average increase from 2004 of 4.4% p.a.

Like most electricity network infrastructure, ENLs distribution assets are dispersed over a large area and are highly interdependent. Although the service area includes Gisborne City and Wairoa Township, the existing network is predominantly rural in character. It is also the cumulative result of almost 80 years investment and development.

The average age of the distribution network at the beginning of the planning period is estimated to be 27 years. This is expected to increase over the planning period with the estimated average age in 2021/22 being 30.5 years.

## **Service levels**

The overall objective of asset management is to ensure the most efficient and optimum investment in assets to provide desired service delivery. Performance targets are established by considering a wide range of business and asset management drivers, some directly influenced by stakeholders, others a result of the historical pattern of development of ENLs network. ENL has surveyed customers and their representative groups in various market segments and considers their views and willingness to pay when making base investment decisions.

A backlog in network renewal existed at the start of the 2000/01 planning period, which evidenced itself in an aging network and poor reliability and safety performance. Between 2000 and 2004 significant network condition issues were corrected, providing a network configuration and capacity that is sufficient to meet current regulatory service targets. Between 2004 and 2008 implementation of automation in the rural areas was introduced to offset the aging asset to maintain service targets at the steady state. While ultimately it is customer requirements and financial commitments that drive work programs, the AMP forecasts steady state service levels for the planning period as investment to improve service beyond regulated levels is seen as over investment and as such cannot be justified.

Over the planning period steady state reliability performance and regulatory performance targets reflect the expected result of the physical behaviour patterns of the physical assets, modified by the asset management actions described in this plan. As the time frame covering historical trend data begins to match that of the asset lives the certainty of predictions will improve. Currently a shortfall is identified between renewal investments versus required renewal

rates for certain types of asset. This will result in the average age of the network to increase and a backlog of asset renewal may occur over time. As the average age increases there is a risk that performance may decline in some areas. Issues regarding levels of achievable network investment and the effect on operational performance are being continually reviewed, as the data trends increase in accuracy, and will be updated as appropriate in future versions of the AMP.

ENL describes levels of service delivery and efficiency using well the recognised and disclosed industry performance measures. The method for calculation of the measures is in accordance with prescribed rules. The most significant reliability measure is the System Average Interruption Duration Index ("SAIDI"), which indicates network performance in terms of the interruptions experienced by customers.

Key reliability and efficiency performance targets for the next 10 years are indicated:

Measure	2010/11 Actual	2011/12 Target	2012/13 Target	2013/14 Target	2014-2022 Target
SAIDI B+C	334	285	307	307	307
SAIFI B+C	3.5	4.0	4.2	4.2	4.2
CAIDI B+C	95	71	73	73	73
Operational Expenditure \$/km	1594	1700	1700	1700	1700
Operational Expenditure \$/connection	228	240	240	240	240

In accordance with the Commerce Commission Targeted Control Regime for lines businesses ENL is required to comply with a quality threshold. This means its annual SAIDI and SAIFI performance cannot exceed the current set 5 year averages of SAIDI = 302 and SAIFI = 4.2. This threshold is determined from historical performance and has not allowed for the planned activities required to achieve asset management objectives and the increase in asset age going forward; hence it is very likely ENL will not comply with the thresholds set.

It should be noted that external influences such as severe weather events and foreign interference dramatically impact upon reliability statistics and year-to-year variances can be large. Also extrapolation limits the probability of achievement the further projections are extended.

ENL's overriding objective in setting service levels is to deliver customer value by matching the performance of its assets and all asset activities to the performance customers expect and are willing to pay for, and the returns on investment required by the shareholder. The targets are

established to reflect average performance within a benchmark group of utilities of similar size, customer density, urban/rural split, and transmission remoteness.

Maintenance expenditure is the dominant component of the disclosed direct cost efficiency measure. ENL has previously achieved a lower than average industry level of direct cost expenditure however the forecast shows an increase to reflect the increase in maintenance and regulatory compliance costs as capital development stabilises.

The indirect cost expenditure forecast has been amended to reflect changes to the historical management structure that was unsustainable when considering normal commercial, asset management, operational and regulatory resourcing requirements. These increasing requirements have resulted in both additional support roles being developed and allocated to ENL.

## **Lifecycle & development plans**

Growth trends indicate a reasonably low average peak demand increase over time with significant variation. Growth is uncertain and is driven by the region's economic outlook, and in the longer term, by changes in technology and other factors. Growth is particularly sensitive to the pattern of development of the regions forestry resources, gas resources and industry. New technology and the use of distributed generation represent very real opportunities for ENL to reduce the need for future transmission and sub-transmission network upgrades.

Facing the challenges associated with serving a consumer base that is very different to what was historically planned for ENL has used a variety of load forecasting techniques to help predict the impact of accumulated load growth on its capacity requirements and security standards. The coincident system peak demand has been forecast to grow from 56 MW in 2010/11 to a worst case of 93 MW in 2022. This gives an overall growth rate of approximately 1.8% p.a.

Alternatively the conservative growth scenarios indicate minimal growth to 61 MW in 2022 which equates to a rate of 0.25% p.a.

Predictions consider both an optimistic/worst case and conservative projection from the most recent actual to ensure timely planning. This forecast includes foreseeable industrial developments.

Specific triggers have been identified for major upgrades to ensure efficient investment to meet security standards and avoid capacity constraints.

Life cycle management plans outline exactly what is planned to manage and operate the assets at the target levels of service while optimising lifecycle costs. An assets life cycle starts with planning its necessity, continuing through design, investment, operation and maintenance, and concludes with replacement and/or disposal. Life cycle asset management encompasses the policies and practices applied during all phases of an assets life to ensure the sustainable delivery of a power supply in the most efficient manner.

ENL uses load flow analysis to assist in identifying solutions to network issues such as capacity constraints, security, power quality and uneconomic supplies. Alternative scenarios and options are modelled to optimise development plans, while the timing of work is largely determined as secure load limits are exceeded or requests for additional load are received.

Detailed life cycle management plans are prepared by asset and expenditure category. Capital plans present background data and plans for renewal, replacement, augmentation and non-asset solutions in response to asset aging, growth, reliability, performance, compliance and quality. Maintenance plans detail the regular on-going work that is necessary to keep assets operating, including the basis for condition monitoring, equipment standards, planned maintenance and provisions for unplanned actions in response to faults or incidents. ENL drives maintenance work based on condition and reliability assessments, as opposed to planned maintenance based on time usage of an asset.

Since ENLs assets are in the age replacement phase of their life cycle, the management tactic focuses on replacement over heavy maintenance. The average age is forecast to increase as existing population profiles for conductor and poles in particular show the predominant installation period is nearing end of expected life while renewal rates have been minimized to balance renewal costs with allowable regulated revenues and return on asset value requirements.

## **Risk assessment**

Effective risk management is required to protect the long-term viability of ENL and to protect its stakeholders. ENL uses a systematic outcome-based method for assessing asset related risks. This focuses on identifying and prioritising mitigating actions, which are subsequently captured in work programs and network development plans.

## **Financial Summary**



## Capital Expenditure

Total capital expenditure over the planning period, as described in Sections 4.0 and 5.0, is \$56.880m. The expenditure profile is relatively flat with an average expenditure of approximately \$5.6 m pa, indicating that steady state assumptions apply. This level of capital expenditure equates to approximately 1.8% of the asset replacement cost and based on the 2011 Information Disclosure statistics is below the industry average of 3.22%.

Capital expenditure forecasts for the planning period are provided by asset type and expenditure category in accordance with the Information Disclosure requirements. Comments on the categories of expenditure are made below.

## Customer Connection

Where assets are required to be installed to facilitate a new, upgraded or altered customer connection it is ENL policy that cost responsibility resides with the customer. Accordingly the majority of Customer Connection expenditure is funded by customers who engage directly with ENL authorised contractors to carry out the required work with the ownership of network type assets being vested to ENL upon completion.

For the planning period the total \$900k Customer Connection expenditure is 1.6% of the total capital expenditure forecast for the period. This unplanned expenditure allowance is based on historical actual spend associated with the provision of new or upgraded assets which cannot be reasonably expected to be met by the customer. Customer connection expenditure directly with contractors is not included in the forecast amounts.

## System Growth

For the planning period the total \$11.1m System Growth expenditure is 20% of the total capital expenditure forecast for the period.

This category of expenditure includes provision for the steady state customer driven network extension and capacity upgrades that cannot be avoided. The only major projects included are those where the upgrade triggers are currently exceeded. Trigger levels for growth upgrades predicted are described in Section 5.5.

A key feature of these projections is that while the AMP attempts to predict the impact of growth on network development, probable timings, etc. these issues are excluded from financial planning until more certainty on size and location and optimum response is evident.

## Asset Replacement and Renewal

Asset Replacement driven capital expenditure for the planning period averages \$4.26m p.a., and is \$42.6m in total. It equates to 75% of the total capital expenditure forecast for the period. This category of expenditure per asset type is described in Section 5.4, The predominance of this category of capital expenditure in the total expenditure for the period reflects the increasing average age of network assets, (especially poles and conductor) and that many assets are in the age replacement phase of their life cycle. Asset Replacement expenditure is predominantly funded by depreciation. The forecast depreciation for 2012/2013 is \$4.3M with Asset Replacement and Renewal capital expenditure budgeted at \$4.2M.

A previous issue regarding a “gap” between the failure and renewal rate of 11kV poles has been addressed by increasing the pole renewal budget to match the 10 year replacement rate.

An 8km pa “gap” between the 10 year renewal rate and targeted renewal rate for 11kV conductor remains. It is expected that this “gap”, (which equates to \$500k pa) will be mitigated through the planned age extension/value reduction of uneconomic network segments and increased forecasted maintenance expenditure. Also performance to date indicates that the actual life of conductor is much greater than that forecast. It is not expected that the conductor renewal “gap” will unduly affect the achievement of levels of operational performance required by regulation or expected by customers.

## Reliability, Safety and Environment.

Reliability, Safety and Environment driven capital expenditure for the planning period is \$1.75m and equates to 3% of the total capital expenditure forecast for the period.

This relatively low level of expenditure in this category is a result of large levels of expenditure that was undertaken between 2000 and 2004 for the purposes of addressing a backlog of safety and environmental issues and improvement of security of supply standards through the development of the sub-transmission network.

It should also be noted that a consequence of ENL’s significant asset renewal program is an improvement in reliability, safety and

environmental performance hence dedicated expenditure in these areas is not generally required.

### **Asset Relocation.**

Asset Relocation driven capital expenditure for the planning period is an annual unplanned allowance of \$50k pa based on historical actual spend. Territorial authorities operating in ENL's network coverage area have been canvassed as late as March 2011 for information on immediate future and longer term requirements they might have regarding the relocation of ENL assets. Responses received did not identify any specific requirements to relocate ENL assets.

Asset Relocation capital expenditure equates to 1% of the total capital expenditure forecast for the period.

### **Overhead to Underground Conversions**

For the planning period total of \$1.75m is forecast for overhead to underground conversions.

### **Maintenance Expenditure**

Total maintenance expenditure over the planning period, as described in Section 5.3, is \$28.837m. The expenditure profile is flat with forecast annual expenditure of \$2.883m. This level of expenditure indicates that steady state assumptions apply. Maintenance expenditure forecasts for the planning period are provided by asset type and expenditure category in accordance with the Information Disclosure requirements.

### **Routine and Preventative Maintenance**

This expenditure that is driven by pre-planned and programmed work schedules and includes routine inspection, testing and vegetation management activities.

For the planning period the total \$15.669m Routine and Preventative expenditure is 54% of the total capital expenditure forecast for the period.

### **Fault and Emergency Maintenance**

For the planning period the total \$10.368m Fault and Emergency expenditure is 36% of the total maintenance expenditure forecast for the period. As described in section 5.3.1 included in this expenditure category is a standing allowance of \$273k pa for provision of a 24hr x 7day faults call centre and a fault management/response service.

## **Refurbishment and Renewal Maintenance**

For the planning period the total \$2.8m Refurbishment and Renewal expenditure is 10% of the total maintenance expenditure forecast for the period. This level of expenditure is relatively low as a result of the large capital asset replacement and renewal program

## **Performance & improvement plans**

Improvement of the assets is achieved by strategic and business plans which contain agreed guidance and criteria. The primary responsibility of the asset management team is to identify options for improvement and asset management plans for input into the strategy and business planning process. The resulting improvement is continuous as the AMP is updated during the normal business planning cycle. Internal and external audits/reviews are undertaken at regular intervals to confirm the validity of technical content, assess asset management performance against best practice, and identify areas where implementation of asset management practice can be improved.

ENL reviews benchmarking results for similar companies in order to more effectively target improvements in line with national trends. Performance measures have been developed to ensure that meaningful comparisons with comparable lines companies can be undertaken and compliance with regulatory targets is maintained.

On-going asset management improvement initiatives target increased capture of detailed asset attribute and performance information, to aid predictions, which facilitates the development of improved capital and maintenance strategies to correct condition and asset deficiencies and meet growth requirements.

The primary indicators for reliability and performance are the SAIDI index and SAIFI index

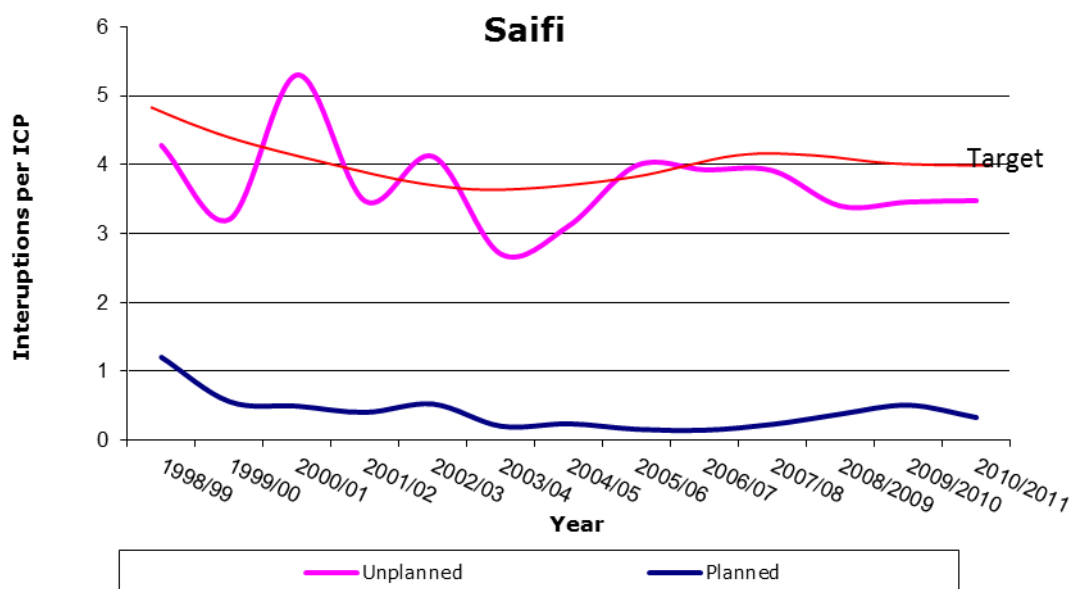
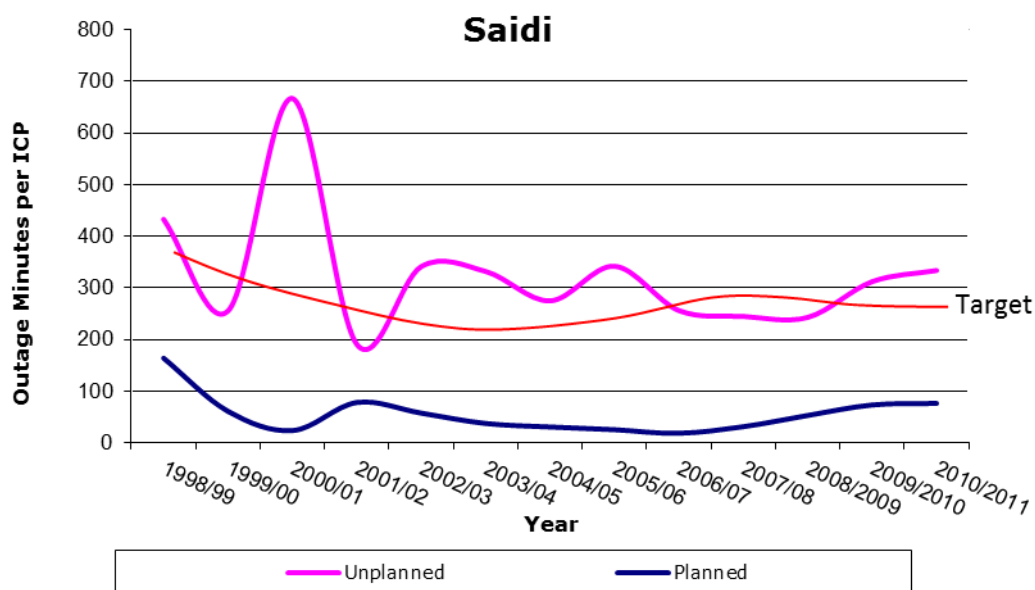

Installation of remote diesel generators between 2002 and 2003 has reduced the impact of planned outages. On average over the past 6 years use of generators has avoided 254 SAIDI minutes p.a., or 50% of the current level, p.a. over the period. The extent of this reduction cannot be seen in the statistics as pole replacement on spur 50kV lines, previously deferred, was undertaken between 2003 and 2008 without any impact on outage statistics.

Use of Live line technologies has avoided an average of 10 SAIDI minutes p.a. between 2001 and 2008. As a result of skill shortages in 2007 and 2008 and an increase in line renewal work over rugged terrain, the use of Live Line technologies is currently suspended. While the targeted SAIDI is below the regulated limit a shift to renewal projects on lines not suited to generator support will increase planned SAIDI figures. It is likely that the regulatory limits

will be exceeded in future due to this increase in necessary maintenance and renewals work on the rural or spur lines. Significant weather events and environmental factors such as slips after long periods of rainfall, generally considered as normal, have the most significant impact on ENL's ability to achieve its targets. The low proportion of planned to unplanned makes it difficult to control to targets by manipulation of planned work. Where viable multiple contractors are pooled into a collective group for shutdown work to minimise the need for multiple outages on a specific project. An example of this is a pole replacement project in Wainui where 7 separate companies were collectively engaged to minimise the number and length of outages for the project.

Asset Condition has been identified as having a gap in terms of currently targeted renewal quantities verses forecast expectations of asset failure for some asset categories. The installation profile of the overall asset and historical practices has provided a 'bow wave' effect where at some point the steady state approach for asset renewal adopted by ENL to manage expenditure in line with the current regulated revenue regime will not keep up with the asset deterioration. However through implementing a process that prioritises the replacement of specific assets and age extension maintenance practices it is forecast that asset deterioration should not noticeably affect network performance.

From 2006 to 2008 a decline in available field service contracting resources in New Zealand has resulted in critically low resource levels in the local region. ENL is actively contributing to training and development of new resource at the entry level to ensure improvement of its asset management activities in the long term. ENL has a technology focus and is active in identification and development of equipment and systems designed to offset the effects of renewal investment and resourcing short falls.

Membership, strategic partnership and alliances continue to improve ENL's understanding and input into the direction of the industry. In March 2011 the primary training facility for Line-mechanic's closed leaving no training facility for line-mechanics in NZ. ENL is actively supporting establishment of distribution line mechanic training for the future.

# Contents

Summary of ENL's AMP.....	2
Purpose of the AMP.....	2
Completion date & planning period.....	2
AM systems & information .....	3
Asset description.....	4
Service levels .....	5
Lifecycle & development plans .....	7
Risk assessment .....	8
Financial Summary .....	8
Performance & improvement plans .....	12
Contents.....	15
<u>1. Background &amp; objectives</u> .....	17
1.1 Purpose of this AMP.....	17
1.2 Interaction with other goals & drivers .....	17
1.3 Period covered by this AMP .....	22
1.4 Stakeholder interests .....	22
1.5 Accountabilities for asset management .....	26
1.6 ENL's processes & systems.....	34
<u>2. Details of ENL's assets</u> .....	43
2.1 ENL's distribution area.....	43
2.3 Age & condition of assets by category .....	100
2.4 Justification for assets .....	128
<u>3. Service levels</u> .....	130
3.1 Consumer-oriented service levels .....	130
3.2 Industry and Business performance targets .....	140
3.3 Justification of service levels .....	143
<u>4. Development plans</u> .....	146
4.1 Planning approach & criteria .....	146
4.2 Prioritisation methodology.....	151
4.3 Demand forecast .....	162
4.4 Capacity constraints .....	185
4.5 Use of non-asset solutions .....	187
4.6 Policies for distributed generation .....	188
4.7 Development program .....	191
<u>5. Managing the assets lifecycle</u> .....	222
5.1 What is the lifecycle of an asset.....	222
5.2 Operating the assets .....	224
5.3 Maintaining the assets.....	227
5.4 Renewing assets .....	251
5.5 Up-sizing or extending the assets .....	268
5.6 Retiring of assets.....	282
<u>6. Managing the risks to the business</u> .....	284

6.1	Understanding the business risk profile .....	284
6.2	Identifying specific risks .....	285
6.3	Emergency Response Plans .....	292
<b>7.</b>	<b><u>Funding the business</u></b> .....	<b>300</b>
7.1	ENL's business model .....	300
7.2	Financial Income .....	300
7.3	Financial Projections .....	303
7.4	How is the asset value changing .....	322
7.5	Depreciation and Renewal of the assets .....	323
<b>8.</b>	<b><u>Performance &amp; improvement</u></b> .....	<b>325</b>
8.1	Performance against financial plans .....	325
8.2	Meeting performance targets .....	329
8.3	Meeting Delivery Efficiency targets .....	336
8.4	Asset Management Review .....	338
8.5	Areas for Improvement .....	338
8.6	Improvement Implementation .....	339
<b>A1.</b>	<b><u>Feeder loadings</u></b> .....	<b>341</b>
<b>A2.</b>	<b><u>Disclosure Requirement 7(2)</u></b> .....	<b>368</b>
<b>A3.</b>	<b><u>Disclosure Requirement 7(5)AM1</u></b> .....	<b>372</b>
<b>A4.</b>	<b><u>Director certification</u></b> .....	<b>373</b>



# **1. Background & objectives**

## **1.1 Purpose of this AMP**

The purpose of this AMP is to provide a management framework that ensures that ENL...

- Sets service levels for the electricity network that will meet owner, consumer, community and regulatory requirements.
- Understands what network capacity, reliability and security will be required both now and in the future, and what issues drive these requirements.
- Has a robust and transparent process in place for managing all stages of the network asset life cycle from conception to removal.
- Has adequately considered the classes of risk the network business faces, and has systematic processes in place to mitigate identified risks.
- Has made provision for funding phases of the network asset lifecycle while balancing levels of investment against allowable regulated revenue and return on asset value requirements.
- Makes decisions within systematic and structured frameworks at each level within the business, and that it especially doesn't make ad-hoc decisions.
- Has an ever-increasing knowledge of discrete asset components including locations, ages, conditions, performance and likely future behaviour as components deteriorate, age and are required to perform at different levels.

Presentation of the AMP in this format also meets the requirement 24 of the Electricity Distribution (Information Disclosure) Requirements 31 October 2008 and subsequent amendments.

## **1.2 Interaction with other goals & drivers**

All of ENL's assets exist within a strategic context that is shaped by a wide range of issues including ENL's Statement of Purpose and Vision,

the prevailing regulatory environment, government policy objectives, commercial and competitive pressures and technology trends. ENL's assets are also influenced by technical regulations, asset deterioration, the laws of physics and risk exposures independently of the strategic context, and indeed these issues may constrain the strategic plan.

### **1.2.1 Corporate purpose & vision**

ENL's statements of purpose and vision therefore communicate a strong focus on the development of the local economy.

#### **STATEMENT OF PURPOSE**

**Eastland Network will utilise existing assets to achieve an appropriate return for the shareholder while providing opportunities for business growth and improving the value delivered to customers.**

#### **VISION**

**Eastland Network will provide returns on assets, growth on investments and operating performance which places it in an average position relative to other New Zealand electricity companies with similar geographic, demographic and loading and fixed asset investment characteristics.**

Safe, reliable and optimally-priced delivery of electricity influences the competitiveness of local wealth creating businesses. If they don't create long-term sustainable wealth ENL loses out as well.

### **1.2.2 Vision for asset management**

ENL's vision for asset management is...

## VISION FOR ASSET MANAGEMENT

**Eastland Network's asset management function will strive to optimise its' investment in electricity distribution assets to provide levels of service that are acceptable to its customers and other stakeholders at a price that maximises economic efficiencies.**

The key aspect of implementing this vision is through having well defined and robust processes for optimizing spend levels at all stages of asset lifecycles. These processes are discussed in Section 1.6 of this AMP.

### **1.2.3 Overview of asset management process**

ENL's core planning document is the Strategic Plan which considers all the strategic drivers depicted in figure 1.2.3(a). The Strategic Plan regularly examines these issues at intervals appropriate to how fast each issue moves, and identifies the few important things ENL must focus on to fulfill its Statement of Purpose and its Vision. A key influencer of ENL's Strategic Plan is the increasing level of regulation that the lines sector faces – not only are ENL's prices and supply quality regulated, but many of ENL's activities such as the preparation of this AMP and disclosure of performance indices are heavily prescribed.

The relationship of the AMP to the Strategic Plan needs to consider the following issues;

- The physical degradation of ENL's assets due to age and operating characteristics is largely independent of ENL's chosen business strategy (notwithstanding decisions to spend on the assets) and of the regulatory framework.
- The nature and configuration of ENL's assets reflects past business strategies and policy environments more strongly than present strategies, e.g. past rural electrification has resulted in segments of network considered uneconomic in the current environment.

The preparation of the AMP proceeds in parallel with the preparation of the Strategic Plan and is shaped by it rather than being absolutely dependent on it.

Figure 3.1 - The ENL Asset Management Framework

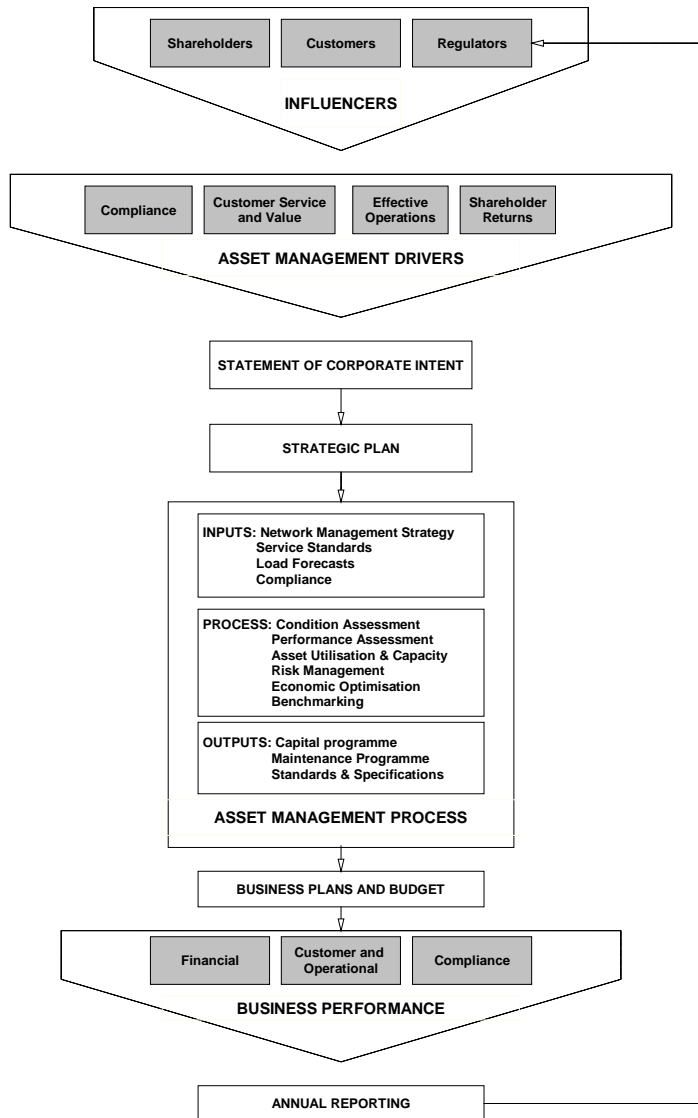

### 1.2.4 Interaction of key planning documents

Interactions of the key planning documents are as follows...

- Statement of Corporate Intent. This document defines the Director’s intentions and objectives for ENL for the next three financial years and is agreed with the owners. This encompasses planned business

activities and objectives, values, performance targets and communication methods.

- Strategic Plan and Business Plan. Annual plans and key initiatives are established in these documents to support the achievement of performance targets. Because the AMP is a tactical plan and a repository for detailed asset information, these documents are closely coordinated during the business planning cycle.

Ten Year Financial Plan. The Ten Year Financial Plan identifies funding requirements necessary to achieve the capital and maintenance budgets as produced by the AMP, and any other business funding requirements. The Financial Plan identifies funding constraints that may affect the ability to achieve AMP objectives thereby influencing changes to the AMP and/or demonstrates that business performance and service objectives can be met.

Customer Relationship Management Plans. These plans record consultations with major electricity users regarding their current and future electricity supply requirements and their preferences for price and quality trade-offs. ENL also seeks to determine the needs of all electricity users from the Energy Retailers that represent them. The Energy Retailers have contractual arrangements with ENL that incorporate the desired requirements for energy delivery services to their customers. ENL focuses on the wealth-creating sector of the local economy and also consults with a number of other representative community groups such as Federated Farmers and Grey-Power as proxies for the mass-market.

The outputs from the asset management process are the operational, maintenance and capital work programs. These programs are contained within the AMP and include...

- Operational Activities. The operational triggers and activities are described in Section 5.2.
- Maintenance Plans. The trigger points and activities for maintaining the assets are presented Section 5.3.

- Capital Replacement Plans. Analysis of asset performance age and condition result in optimal asset renewal programs presented in Section 5.4.
- Development Plans. Analysis is undertaken to test growth and performance against service standards. A Network Development plan is then created in line with investment and risk policies. This is summarised in section 4.7.
- Equipment and Design Standards. Detailed equipment and design specifications, based on the required functionality of the assets, are included in the Network Quality System. General standards and issues concerning quality and compliance are covered in the lifecycle management sections of this AMP.

### **1.3 Period covered by this AMP**

This edition of ENL's AMP covers the 10 year period 1 April 2012 to 31 March 2022.

This AMP was prepared over the period November 2011 to March 2012 by Eastland Group's General Manager Energy and the Asset and Planning Manager.

The AMP was approved by the ENL Board of Directors on 23 March 2012 and publicly disclosed in accordance with Requirement 24 of the Electricity Information Disclosure Requirements 2008.

### **1.4 Stakeholder interests**

#### **1.4.1 Stakeholder identification.**

ENL defines its stakeholders as any person or class of persons that does or may do one or more of the following...

- Has a financial interest in ENL (be it equity or debt).
- Be physically connected to ENL's network.
- Use ENL's network for conveying electricity.
- Supply ENL with goods or services.
- Be affected by the existence, nature or condition of ENL's network.
- Have a statutory obligation to perform an activity in relation to the existence of ENL's network (such as request disclosure data or regulate prices).

## 1.4.2 Stakeholder interests

The interests of ENL’s stakeholders generally fall into 1 of the 4 categories defined in Table 1.4.2(a) below...

**Table 1.4.2(a) – Key stakeholder interests**

	Interests			
	Viability	Supply quality	Safety	Compliance
Shareholder	✓		✓	✓
Bankers	✓			
Connected customers	✓	✓	✓	
Energy retailers	✓	✓		
Mass-market representative groups	✓	✓		
Industry representative groups	✓	✓		
Staff & contractors	✓		✓	✓
Public			✓	
Councils (excluding as a consumer)			✓	
Land Transport			✓	✓
Ministry of economic development			✓	✓
Commerce Commission		✓		✓
Electricity Authority				✓
Land Owners			✓	

## 1.4.3 Determining stakeholder interests

Stakeholder interests are determined via the following mechanisms...

Shareholders – Regular business performance reviews are conducted by the shareholders. Correspondence and meetings are held between the shareholders and ENL’s directors /Management team to review performance and consult on strategic plans.

Bankers – Communication via direct discussion and written correspondence at regular intervals ensures that the formal agreements and interests of the bankers are adhered to.

Customers and representative groups – The interests of these stakeholders are determined through direct discussion with large customers, meetings with consumer and industry representatives, and customer surveys (refer section 3.1). ENL representatives are involved with the civil defence, Gisborne chamber of commerce, Regional development groups and regional working groups. At an operational

level customers communicate their interests directly with either Engineering staff or ENL’s call centre.

Staff and Contractors – Weekly meetings are held with contractors and staff which provide an open forum to determine and discuss individual interests and interests fed back from customers and the public via the individuals. All information is recorded and incorporated into revised plans where relevant.

Public – Public interests are generally relayed via local media, other authorities and representative groups. ENL provides open access for the public to engineering and management staff at its main offices in Gisborne and via its call centre.

Councils and Authorities – Monthly Utility meetings are held with representatives from Telecommunications, Gas, Council, Road Authorities and General contractors to determine both short and long term interests for incorporation into operational and long term asset management plans. In addition councils are consulted at all levels to establish the potential impacts of ENL strategies and activities.

Ministries and Commissions – The interests of these groups are identified through legislation and regulation. ENL has engaged Price Waterhouse Coopers and Chapman Tripp to monitor and represent ENL in this area. In addition ENL has significantly increased staffing and funding from 2008 to provide information, review and revise systems in order to accommodate the steadily changing requirements.

Landowners – ENL engineering staff maintain a close relationship with Landowners and developers to determine their interests on an open and informal basis. At an operational level formal access and tree notification processes provide for feedback that is incorporated into ENL’s asset management systems.

**1.4.4 Accommodating stakeholder interests**

Table 1.4.2(a) provides a broad indication of how ENL accommodates stakeholder interests...

Interest	Description	Accommodating that interest
Viability	Viability is necessary to ensure that ENL’s shareholder and providers of finance have sufficient confidence to retain ownership of ENL or provide	<ul style="list-style-type: none"> <li>• ENL accommodates its stakeholders’ needs for long-term viability by delivering earnings that are sustainable and reflect an appropriate risk-adjusted return on employed capital</li> <li>• While net prices are controlled to maintain</li> </ul>



	<p>finance to ENL. For users of line function services the prices must be affordable. For other stake holders the activities conducted by ENL should minimise negative impacts on viability of their activities.</p>	<p>compliance, changes to prices are analysed to determine individual impacts and step changes are managed to maintain them within affordable limits.</p> <ul style="list-style-type: none"> <li>• Design standards and selection of assets for each application given careful consideration to ensure they are suited to the stakeholders needs.</li> </ul>
Supply quality	<p>Emphasis on continuity, restoration is essential to minimizing interruptions to ENL's customers businesses.</p>	<ul style="list-style-type: none"> <li>• ENL accommodates stakeholders' needs for supply quality by focusing resources on continuity, provision of security and restoration which is what ENL's customers have said is important to them.</li> </ul>
Safety	<p>ENL's staff, contractors and the public at large must be able to live in close proximity to network assets and/or work on the network in total safety.</p> <p>Lines and equipment on private land must be operated and maintained to minimise interference to other activities carried out on the land and avoid serious harm or damage to property.</p>	<ul style="list-style-type: none"> <li>• ENL ensures that the public at large are kept safe by managing the network assets so that they are installed, operated and maintained to relevant regulations, codes of practice and standards relating to their structural strength, electrical safety and design functionality.</li> <li>• ENL ensures the safety of its staff and contractors through implementation of its Health &amp; Safety Management System which prescribes the process and procedures for hazard identification/management, contractor management/auditing, staff/contractor training &amp; competency assessment, the provision of safety equipment and safe work procedures.</li> <li>• The safety management system documents processes to ensure safe operation of the network assets.</li> </ul>
Compliance	<p>ENL has a duty to comply with many statutory requirements ranging from safety to disclosing information and targeted threshold regimes for price, quality and customer consultation.</p>	<ul style="list-style-type: none"> <li>• ENL ensures that all safety issues are adequately documented and available for inspection by authorised agencies.</li> <li>• ENL discloses performance information in a timely and compliant fashion.</li> <li>• ENL will restrain its net prices to within the limits prescribed by the price path threshold.</li> </ul>

### **1.4.5 Managing conflicting interests**

ENL's priorities for managing conflicting stakeholder interests are...

- Safety. ENL will give top priority to safety. Even if ENL has to exceed budget, the safety of staff, contractors or the public, (and their property) are a primary consideration.

- Viability. ENL will give second priority to sustainable financial viability because without it the business will cease to exist which makes supply quality and compliance pointless.
- Supply quality. ENL will give third priority to supply continuity and quality as this is what makes energy users, and therefore ENL, successful.
- Compliance. ENL has a duty to comply with all the regulatory requirements applicable to lines businesses and endeavours to meet those requirements. However ENL also understands that achieving compliance may on occasion be in tension with other interests such as financial viability. Under these circumstances ENL will decide a course of action that is sustainable and reflects a balanced view of all stakeholder wishes and expectations.

To achieve consistency regarding the management of conflicting stakeholder interests, the priority structure above is considered and applied during ENL's annual Strategic and Business planning cycles. The outcome is that the annual Business Plan provides at an operational level direction and detail on how prioritized objectives set out in the Strategic Plan will be realised and associated performance measured.

## **1.5 Accountabilities for asset management**

The electricity assets of Eastland Network Ltd are 100% owned by the Eastland Community Trust (ECT). The ECT, originally the Eastland Energy Community Trust, was created in 1993 and took ownership of all the Poverty Bay Electrical Power Board's assets following the implementation of the Electricity Companies Act and subsequent Acts. The trustees of the ECT are appointed by the Gisborne District Council, (GDC). The GDC is the ultimate capital beneficiary of the Trust. The ECT also owns other companies forming the Eastland Group, as shown below:

Eastland Group  
Ownership Structure

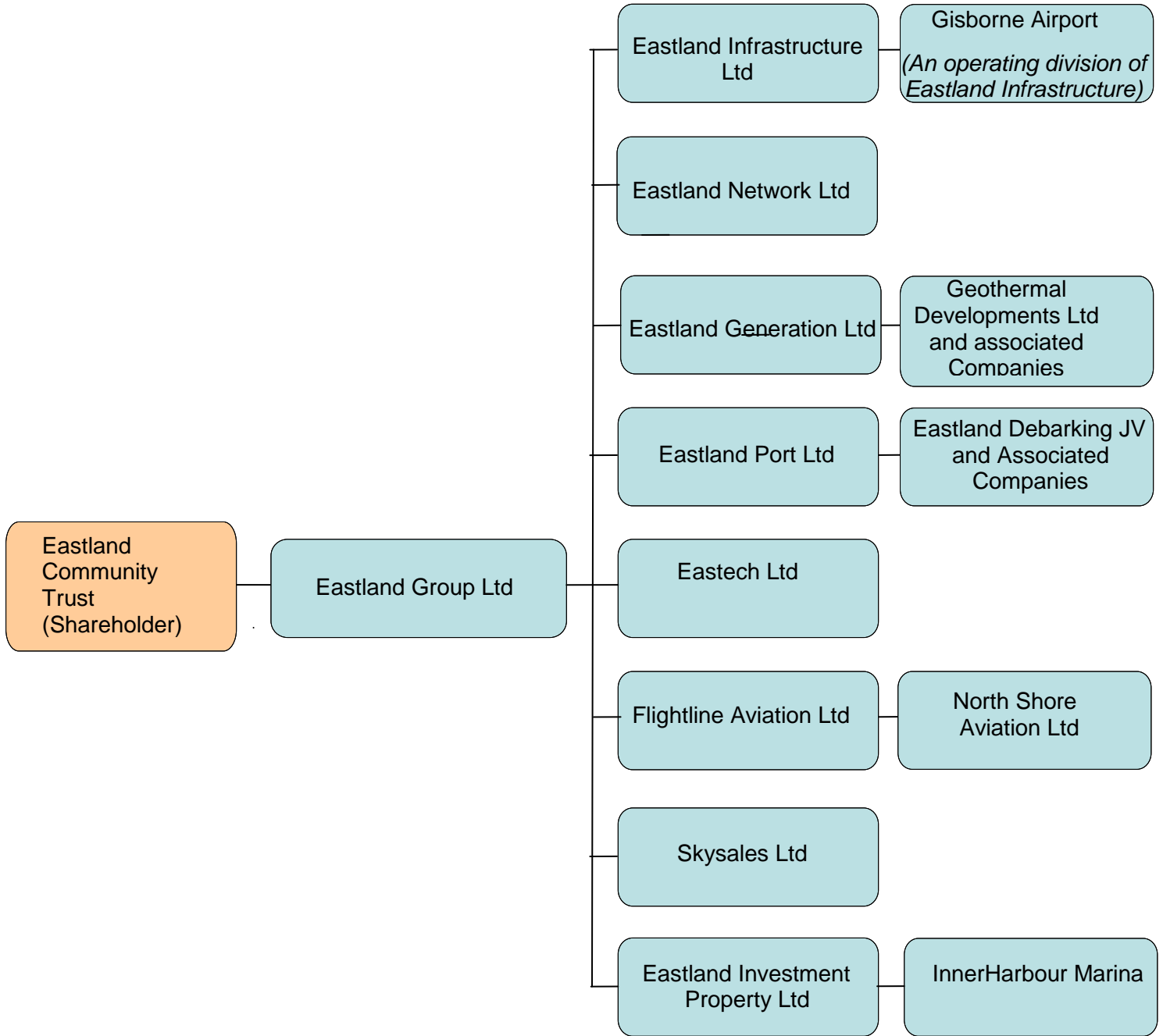

Eastland Group Ltd manages Eastland Network Limited, Eastland Generation Ltd, Eastland Port Ltd and Eastland Investment Property Ltd. Eastland Infrastructure Ltd also manages and operates Gisborne

Airport on a long term lease from the Gisborne District Council. Eastech Ltd, Skysales Ltd and Flightline Aviation Ltd are all owned by Eastland Group Ltd. Together these companies make up the Eastland Group.

Primarily, Eastland Group Ltd is a shared service provider to each of the companies within the Eastland Group. It employees management and operational staff required to operate the companies within the Group. Governance of the Eastland Group is provided by a common Board of Directors appointed by the ECT. This management/governance structure is illustrated below:

*Eastland Group  
Management Structure*

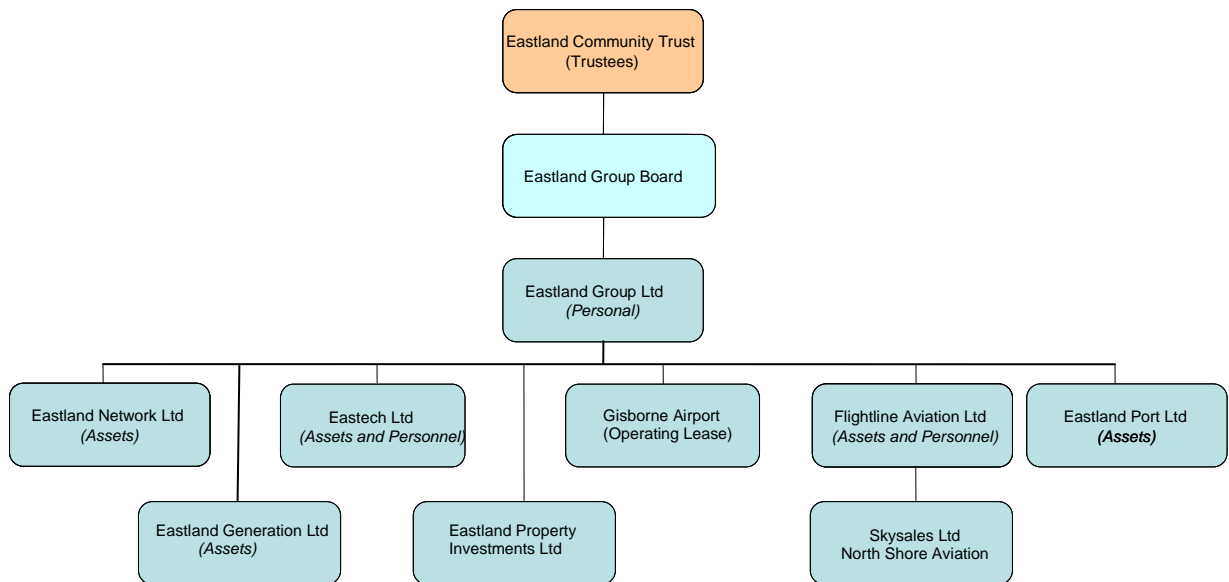

With respect to the management of ENL distribution network assets, EGP provides the services and resources required to carry out all financial management, planning, design and network operating activities. Since all physical installation and maintenance work carried out on network assets is contracted out, the network operating function includes significant responsibility for the management of accredited independent contractors.

Contractors tender for packages of maintenance activity and/or capital works projects. Contracts are awarded on the evaluated performance criteria of price, quality/safety and timeliness. Contract tendering and

management is carried out in accordance with NZS 3910:1998 “Conditions of Contract for Building & Civil Engineering Construction”.

ENL believes that competitive tendering is beneficial for the business as it stimulates contractor innovation and results in field services being provided at the true market rate. As such ENL does not operate a system of preferred contractors. Any contractor is able to tender for ENL work provided that they are able to meet and maintain predetermined standards relating to demonstrating competency, the provision of quality, health & safety and financial management systems.

### **1.5.1 Accountability at governance level**

Governance of Eastland Group is provided by a Board of Directors appointed by the Eastland Consumer Trust.

The inclusion of SAIDI, SAIFI and CAIDI targets and Direct and Indirect cost targets in the Statement of Corporate Intent makes ENL’s Board intimately accountable to the shareholder for these important asset management outcomes. The inclusion of revenue and financial performance targets in the statement makes the Board additionally accountable for overseeing the price-quality trade-off inherent in projecting revenue and network performance.

The requirement for the Strategic Plan, the Business Plan, (including capital and maintenance expenditure budgets), and the AMP to be approved by the Board of Directors on an annual basis adds a further accountability function. On a monthly basis the Board receives updates on progress against service level and financial performance targets. All large projects \$150K or higher are identified to the Board for approval and all purchase contracts in excess of \$250k are approved by the Board. Performance against Statement of Corporate Intent targets is reported regularly to the Shareholder.

### **1.5.2 Accountability at executive level**

Overall accountability to the Board of Directors for the performance of the electricity network, the port and the airport rests with Eastland Group’s Chief Executive whose employment contract specifies *inter alia* the asset management outcomes to be created such as safety, reliability, revenue, profitability and compliance.

### **1.5.3 Accountability at operational level**

The General Manager Energy is accountable to the Chief Executive for the safe, reliable, profitable and compliant operation of the electricity network principally through his employment contract. Accountabilities of the General Manager Energy include overall responsibility for achieving compliance with all Eastland Group corporate policies and procedures, (including planning/reporting, human resource management, health & safety management, environmental management, contract tendering, contract management, regulatory disclosure management and financial/budgetary management).

The General Manager Energy activities, accountabilities, resources and responsibilities for achieving Eastland Group corporate policies and procedures are assigned as follows...

- The long term planning function which undertakes asset planning and design work and includes the company's professional engineering resources and the drawing/information record keeping. Production of this AMP is a key accountability of the Asset and Planning Manager who reports to the Sector General Manager Energy.
- The real-time and short term operations function implements work programs, operates the network, and manages contractors. Delivery of reliability, budget cost, and safety performance are the key accountabilities of this group who on an individual basis are assigned responsibility for the implementation of specific capital and/or maintenance activities and budgets as determined in the AMP. Contract and operation reviews provide additional feedback from contractors.

Close interaction between Planning and Operations is achieved through the stewardship of the General Manager Energy. Real-time, short term and long term planning roles are assigned to individuals based on skills and experience held. Typically all individuals are assigned responsibilities involving both the short term operational and long term planning functions. Group responsibility for real time operation of the control room and the achievement of network reliability, budgetary, safety and environmental performance targets is also shared between the Planning and the Operations people based on capability and experience.

A diagram showing the structure of Eastland Group for the Gisborne based operations is shown below. On the left hand side of the diagram roles primarily associated with the Asset management and operation of ENL are highlighted with the Light Green.

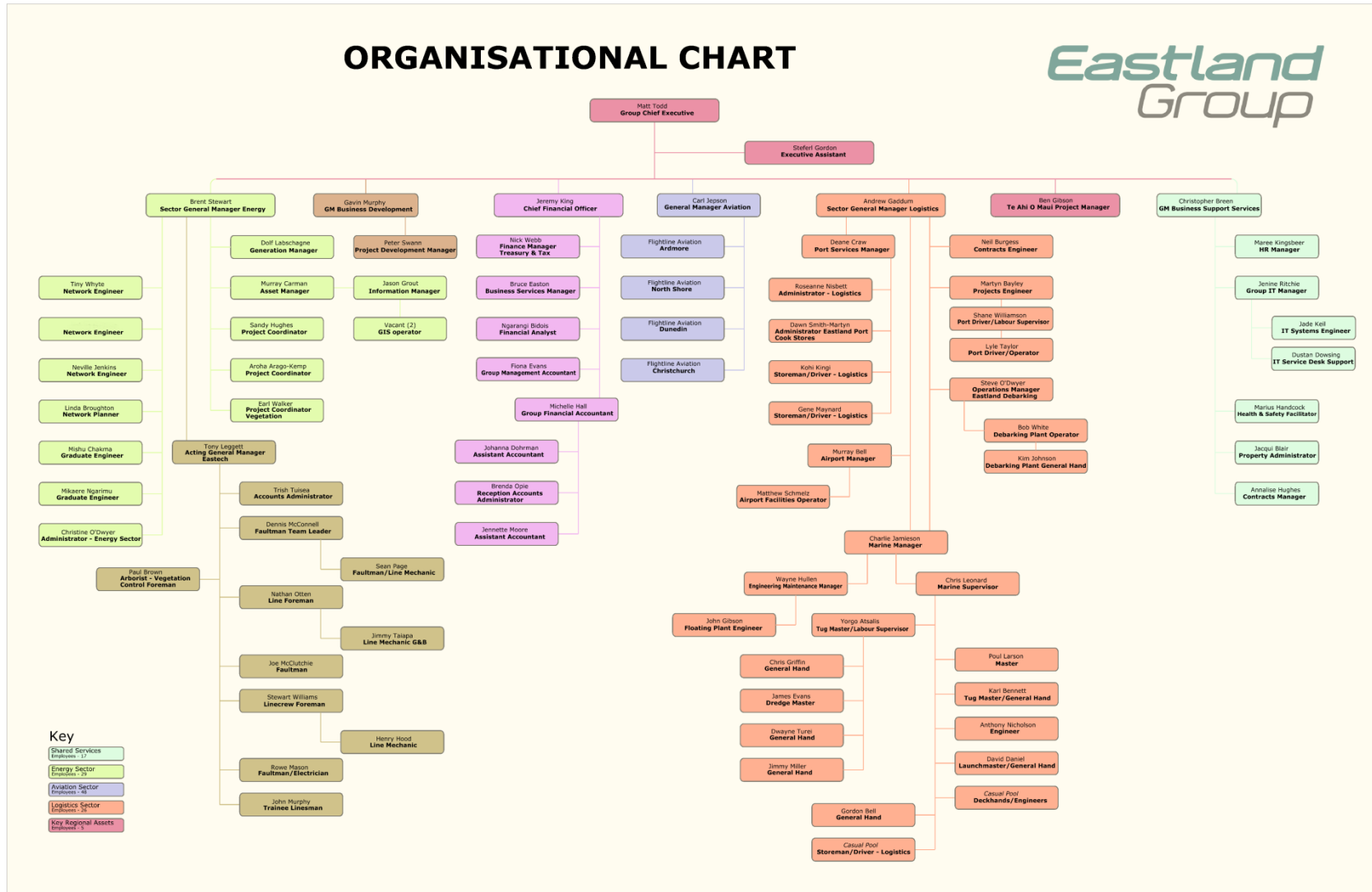



Responsibilities associated with field activities are monitored and managed by the Eastland Group personnel primarily associated with Asset management. Tasks carried out by these personnel include...

- Contractor resource planning
- Consents and approvals
- Shutdown planning and coordination
- Contract preparation ,tendering, management and monitoring
- Work site auditing
- Contractor approvals
- Switching activities
- Fault response and repair coordination

In general all physical installation and maintenance work in the field is contracted out to service providers. Eastland Group personnel assist with the activities to provide the necessary knowledge and experience. This compensates for any skill or resource shortages. The following service providers are used by EASTLAND GROUP for physical installation and maintenance work.

- Electrinet – Cables, Lines, Electrical, Technical
- Colvins – Communications
- CR Taylor – Civil Construction
- Eastech Limited – Primary Fault response, Lines ,Vegetation Management
- Mervs Network Maintenance – Lines
- Powerline Technologies – Fault Response, Lines
- Apex Power Systems Ltd – Inspection, Maintenance
- Power Connections Ltd – Cables, Lines, Fault Response
- Martin Contracting – Inspection Maintenance Fault Response
- Ray Grace Ltd – Civil Maintenance
- Arborcare – Vegetation management
- Eastland Tree Care - Vegetation management
- Roberts Tree Surgeons- Vegetation management
- Gisborne Helicopters - Fault Response, Lines
- 99Corporation– Call centre and Fault response coordination

In addition to physical work a number of these service providers are responsible for Design and planning activities associated with subdivisions, new connections, routine maintenance and asset renewal.

## **1.6 ENL's processes & systems**

The core of ENL's asset management activities lie with the detailed processes and systems that reflect ENL's thinking, manifest in its policies, strategies and processes and ultimately shapes the nature and configuration of its fixed assets. The hierarchy of data model shown in Figure 8(a) describes the typical sorts of information residing within the business which includes that held by employees by virtue of their skills and experience.

**Figure 8(a) – Hierarchy of data**

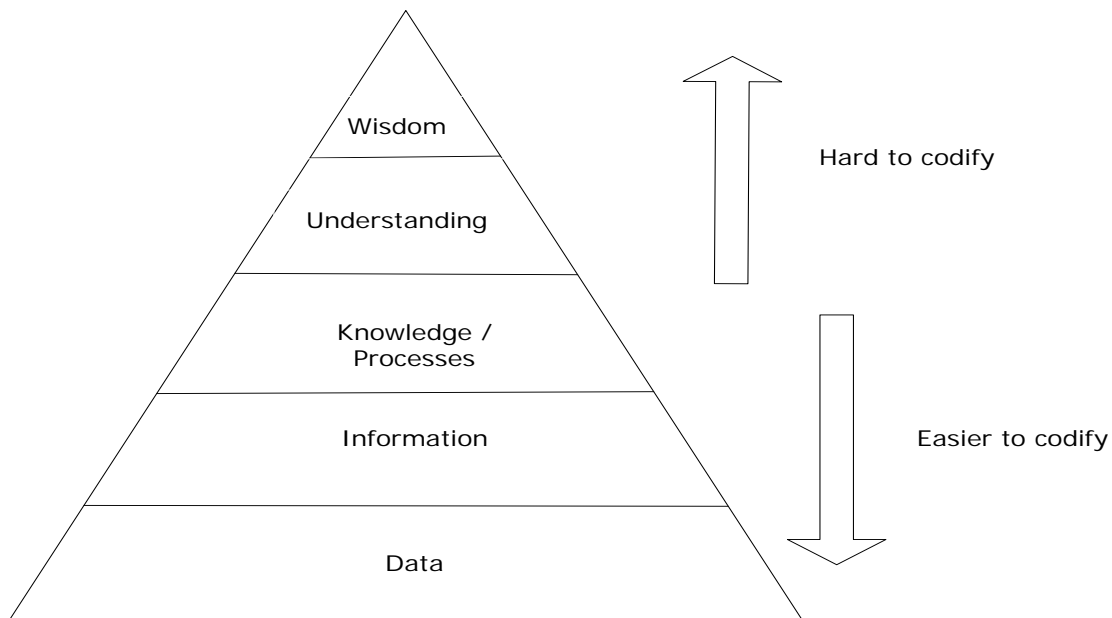

The bottom two layers of the hierarchy tend to relate strongly to the asset and operational data which reside in the GIS and SCADA respectively, and the summaries of this data that form one part of the decision making.

### **1.6.1 Asset Management Wisdom and Understanding**

The top two layers of the data hierarchy tend to be very broad and are often difficult to define. It is at this level that key organisational strategies and processes reside at. As indicated in Figure 8(a) it is generally hard to codify these things, hence correct application is heavily dependent on skilled people. Eastland Group continually improves on these aspects of wisdom and understanding through its staff training and development programs. These layers provide ENL with the ability to establish key initiatives and produce optimum solutions forming the Network development plans in section 4 of this

plan. In addition these layers are key to forming the strategies for managing the assets lifecycle in section 5 of this plan

### **1.6.2 Asset management Knowledge and Processes**

The third layer of the data hierarchy – knowledge and processes– tends to be more broad and general in nature. This layer encompasses accumulated knowledge in the form of processes. Development and review of ENL’s processes is on-going and changes are triggered as needs arise.

The asset management processes collect data and information, identify actions, develop solutions and prioritises the programs for maintenance and asset development to ensure optimum customer service and operational efficiency. Implicit in the asset planning processes is an understanding and evaluation of the risks to operation and the consequences of failure. Also critical is the collection of information from which performance can be monitored and improvement targets set.

The systematic processes that make up the core of asset management practices are those that collect and analyse data. The main processes are:

- **Safety Management**  
Every asset and activity is assessed in terms of the design, hazards, control measures and residual risk. Processes to manage risks relating to Occupational Health and safety, Public safety, and Damage to property requirements are incorporated into all aspects of asset management.
- **Condition Assessment**  
Every asset has a condition assessment action included in its maintenance program. This is used to confirm the necessity of further maintenance, target maintenance expenditure and provide ageing data. (refer Section 5.3)
- **Performance**  
Analysis of reliability statistics provides information on the performance of assets, the effectiveness of work practices, and helps target work programs which result in improved performance. (refer section 3)
- **Asset Utilisation and Capacity**

Load growth and changing profiles are obvious inputs into planning. However security risk and quality issues also require adjustment when load use patterns change. (refer section 4)

- **Risk Management**  
Network related risks are identified and ranked by risk reduction outcomes to help prioritise work programs. (refer section 6)
- **Economic Optimisation**  
The value of a network results from the asset management practices applied. Economic analysis can indicate whether valuation changes and lifecycle costs are in line with long-term sustainable objectives and therefore which tactics are appropriate for different network segments. Economic analysis is also applied to optimise the balance between capital and maintenance decisions across the life cycle of the network assets
- **Design**  
The design process ensures that all assets are installed to enable safe and reliable operation for an established range of operating conditions. New assets utilise design standards that take into account the past performance of previous standards and designs. Modification to designs and standards is managed to continually improve the effectiveness, performance and cost of the assets accommodating new technologies and innovations where appropriate. (refer section 5.5)
- **Benchmarking**  
Analysis of disclosure information and industry benchmarks identifies the practices that are most effective and the performance levels that can be achieved given inherent network characteristics.

### **1.6.3 Asset management Information**

ENL uses the following information systems to store information on its assets, their condition and performance.

- **Works Management System**  
The Works Database provides job cost functionality and is used to manage faults, defects, maintenance and the work management activities over the assets lifecycle described in section 5 of this plan. This is essentially a job and contract management tool with linkages to the GIS and Financial systems to provide cost reporting.

It provides information on progress, commitments, forecasts and cash flow at job and project level.

- **Safety Management System**  
The Safety Management system documents procedures, processes and asset performance information relating to prevention of serious harm to the public and significant damage to property.
- **Financials**  
The company uses ACCPAC as its main financial management IT-platform. This is supplemented with Activa to maintain the financial asset register, which is separate to the engineering asset database.  
The Works Database is reconciled with ACCPAC during monthly reporting.
- **Network Control Systems**  
The SCADA system provides real time operational data and enables remote control of key components of the network. Reporting functions for service levels and performance are also contained within these systems
- **Network Modelling**  
ENL uses PSS Sincal (Power System Simulation/Utilisation) network modelling software to analyse the network and the impact of changes in utilisation and operation. The software is sufficiently sophisticated to permit advanced network optimisation and analysis and assist investment decision-making.  
Internal Line design software and/or Visim software solutions are used for structural engineering/line design.  
LV Drop software is primarily used for Low voltage design.
- **Asset Data Systems**  
The Powerview Geographical Information system operating on a Microsoft Access Databases is used for management of asset data, maintenance and inspection records. A number of associated Microsoft Access Databases / applications are used in conjunction with the Powerview databases to manage non-spatial assets. Between 2002 and 2004, the compliance program and associated data capture has driven major improvements in the completeness and quality of asset information.  
Microstation Draughting Software is primarily used to maintain information in Schematic form. Complex structural and circuitry design information is also stored in the Microstation format. Hard copy records include Maps, field record books, and Maintenance/Commissioning Records.

Genfrac is the product used to manage ICP records in an SQL Database format and linked to the GIS data.

- **Filing Systems**

A manual paper based filing system with cross indexing features is used for long term storage of historical asset management information. New information can either be stored in this system or a computer based replica of the system.

- **Technical Library.** A library of technical information is maintained to ensure information is readily available design, maintain and repair the network asset. The need for EASTLAND GROUP's own standards created in the past has steadily reduced as industry standards, codes and technical information has emerged. Development and review of standards is on-going and changes are triggered as needs arise

### **Information Flows**

The linkage and co-ordination between ENL's asset management processes and systems involves a complex flow of information as shown below;

• Information Flows

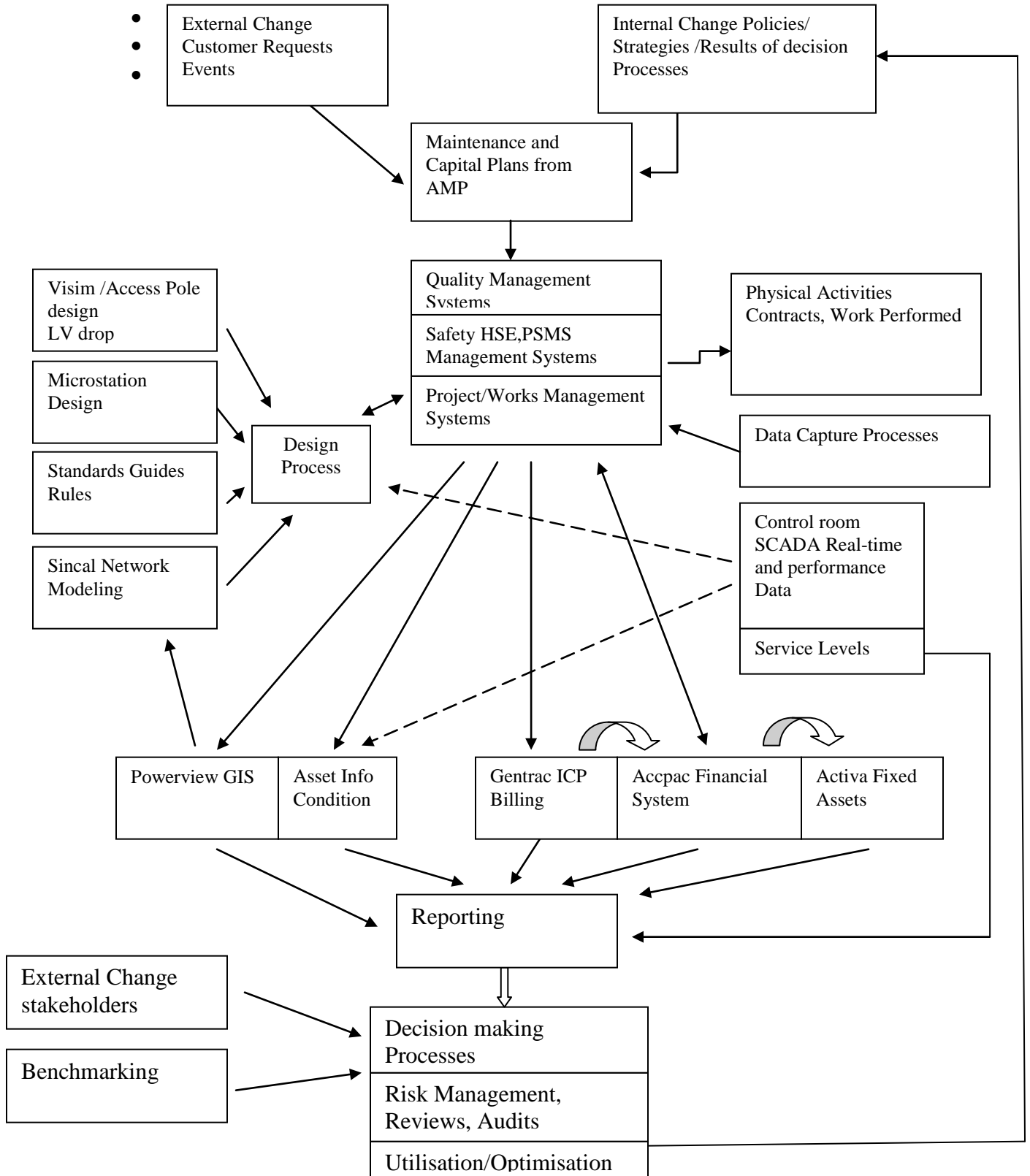

Processes for managing routine asset inspections and network maintenance are managed by the Works Management System which relates the budgeted activities described in section 5.3 of this plan to the physical activities undertaken. As work is completed information is updated in the appropriate data stores and feedback as necessary into the design process or works management system for corrective actions. Urgent actions are dealt with immediately while other data captured is fed into the decision process ultimately shaping future maintenance and/or capital strategies. Real time data and data for determination of service levels a task associated with the Control room operations function. As the data is accumulated it is fed into the reporting systems and decision making process. Not indicated in the diagram is the high degree of interaction between the asset management processes and systems, at multiple levels depending upon the nature and urgency of the information. With the exception of the real time SCADA system all data is initially captured using paper based systems. The safety management system required by the Electricity Act 1992, Act amendments 2006 and Electricity (Safety) Regulations 2009 is closely linked to the works management system. The safety management system documents the information and processes relating to hazards as defined by section 169A of the Act using the format defined by NZS7901.

### 1.6.4 Asset management Data

The following table indicates an assessment of the asset management data and information and accuracy. The percentage completeness indicates the confidence that the asset can be identified as existing as is recorded as existing, while the assessment of accuracy indicates an average confidence in attribute information for the asset. The attribute information for assets varies in significance depending on the nature of the information and how it is used. The assessment of accuracy typically covers key information used to make critical asset management decisions as opposed to the information that guides trends or “nice to know information”.

<b>Data/Information</b>	<b>Completeness</b>	<b>Accuracy</b>
<b>Real time data</b>		
Analog loading substations	97% of all Feeders monitored	+/- 12%



Discrete I/O Status	100% all automatic switches monitored	97% reliable indication
<b>Asset Components</b>		
HV Conductor/Cable	97%	70% certainty in attribute information
Poles	97%	70% certainty in attribute information
HV Switchgear	100%	90% certainty in attribute information
Transformers	100%	90% certainty in attribute information
LV Conductor Cable	90%	80% certainty in attribute information
LV Switchgear	85%	75% certainty in attribute information
Service connections	100%	60% certainty in attribute information
Comms equipment	98%	99% certainty in attribute information
LV Pillars	85%	85% certainty in attribute information
Load control	70%	60% certainty in attribute information
Scada equipment	99%	99% certainty in attribute information
Zone Sub Equipment	99%	80% certainty in attribute information

### Data Improvement Initiatives

Transformer and HV switch assets are key in terms of safety for real time switching operations. The system mimic is verified against the GIS data on a regular basis to identify inconsistencies. In 2010 in-house development of software to automate verification of data between the key systems was developed.

During field operations inconsistencies are easily identified and corrected as they are found.

Historical date attribute information where it is recorded on the equipment is updated on an ongoing basis as it is collected during inspections. Where it is not recorded on equipment the dates typically align with historical records and have proven adequate for asset management decision making to date.

All critical asset management decisions involving the assets a qualified by a field captured condition assessment prior to an action (refer section 5.3) hence there is no need to invest heavily in high data accuracy other than to meet regulatory reporting requirements.

LV switchgear LV Pillars and Load control relays are currently incomplete record sets. Inspection and renewal programs (refer section 5.3.13) for these assets are enabling the accumulation of data for these assets.

ENL recognises a certain degree of incompleteness and inaccuracy of the asset data. The given data still represents a valuable reference source.

There is a trade-off in establishing a 100% accurate dataset and the required resource and cost to do so hence no major data improvement initiatives are warranted or considered necessary at this time.

## 2. Details of ENL's assets

### 2.1 ENL's distribution area

#### 2.1.1 Geographical coverage

ENL's distribution area broadly covers the East Cape and Northern Hawkes Bay areas as shown below within the red ring. This area corresponds to the jurisdictions of the Gisborne District Council and the Wairoa District Council.



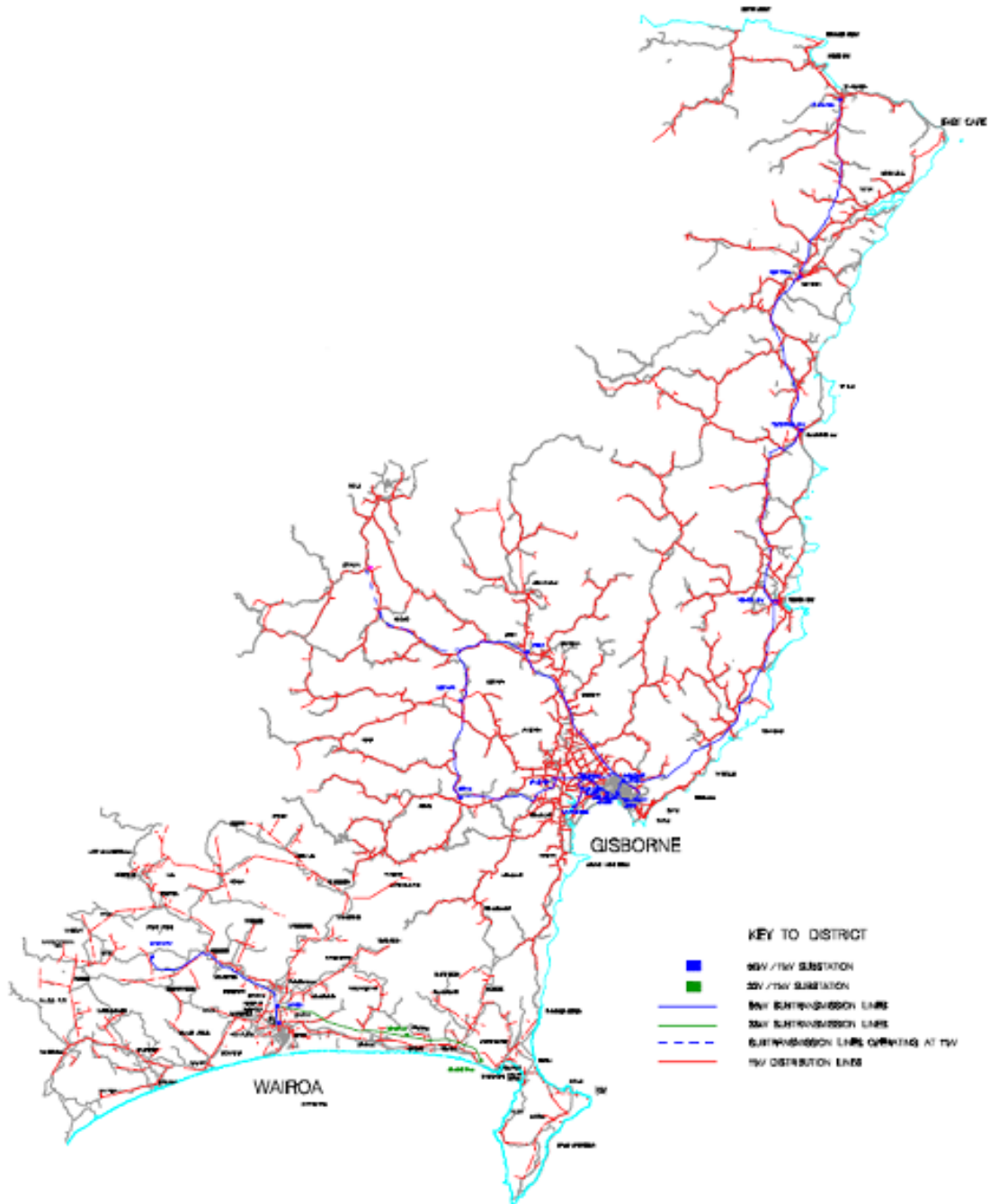

Topography ranges from fertile plains around Gisborne and Wairoa to rugged mountainous areas further inland. The 11kV(red) network is generally consists of ties between substations supplied by the 50kV (blue) and 33kV (green) Sub-transmission, with radial feeds inland via river valleys and ridges.

### 2.1.2 Demographics and Characteristics

The population of ENL's distribution area is approximately 53,000 of whom about 41,000 live in the urban Gisborne area and a further 5,000 live in the urban Wairoa area. The remaining 7,000 live in small settlements (such as Te Karaka, Tolaga Bay, Tokomaru Bay, Ruatoria, Matawai and Mahia) and in rural areas. The last three censi indicate slightly declining populations in both the Gisborne and Wairoa Districts.

It is a feature of the ENL network that 75% of ICPs are Domestic. Accordingly any expected contraction of max demand or network investment requirements due to the slight decline in population is likely to be more than off-set by decreasing occupancy rates (i.e. more dwellings but with fewer inhabitants), increased load (i.e. cheap electric heaters, cheap air-con units) and new connections over-taking a previous trend of rural ICP consolidation. ICP numbers for the past 8 years are;

<u>Year ending</u>	<u>ICPs</u>	<u>Change</u>	<u>Domestic</u>	<u>Non-Domestic</u>
31/03/04	24,849	(-327)	19115	5734
31/03/05	24,854	(+5)	19149	5705
31/03/06	24,871	(+17)	19228	5643
31/03/07	24,975	(+104)	19324	5651
31/03/08	25,196	(+221)	19513	5683
31/03/09	25,300	(+104)	19554	5746
31/03/10	25,432	(+132)	19691	5741
31/03/11	25,514	(+82)	19748	5766

Specific load characteristics for different parts of the region are described in 2.2.3. The following map showing the percentage load density per square km provides an overview of the regions characteristic. The majority of the line assets are associated with load densities below 1% of the regions total demand per sq. km, while Gisborne and Wairoa Urban centres have the regions highest load density.

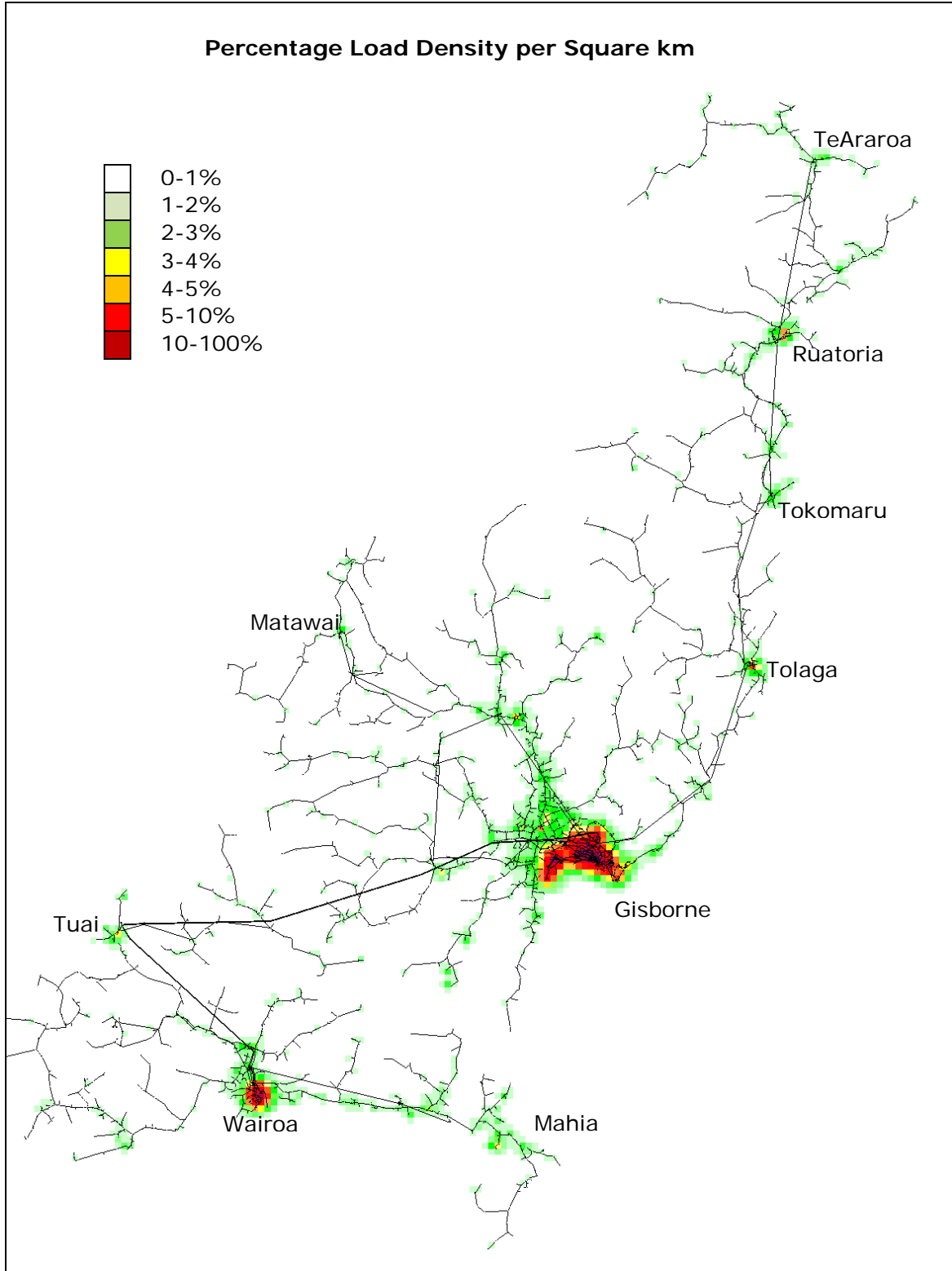

### **2.1.3 Key industries**

Key industries relate strongly to the primary produce value chain – cultivation, harvesting, processing, storage and transportation of timber, root and leaf vegetables, pip and stone fruits, grapes, meat and fin fish. There are a number of significant processing and storage installations on the western outskirts of Gisborne, clustered in the Gisborne industrial estate, the Gisborne Port area and in Wairoa.

The companies located in these areas which have a significant impact on the regions demand are listed in the table below.

<b>Industry</b>		<b>Demand</b>
Juken NZ Limited	Timber Processing - Gisborne	3.5MW
Affco	Meat Processing -Wairoa	3.5MW
Bernard Mathews	Meat Processing- Gisborne	2MW
Tairawhiti Healthcare	Heath care provider- Gisborne	2MW
Cedenco	Food processing- Gisborne	2MW
Eastland Group	Cool Store Operations- Gisborne	1.5MW

The nature and size of the operations carried out by these industries does not significantly impact on the network at an individual level. However the combined consumption of these companies on average is 15% of the total energy conveyed and 25% of the total demand for the region. Direct contact is maintained with these companies to assess their needs and adequacy of current service levels.

There are no issues associated with the operations of these companies, e.g. changes in demand are not expected to have a significant impact on the network over the planning period.

A key issue arising from the nature of these consumers is because of the nature of their industrial processes they have gradually increasing requirement for continuity of supply, improved restoration times and less flicker and sag.

Eastland Group regularly engages with customers on all manners of business and common interest. Also Eastland Group uses an external advisor to formally consult with the 25 largest, (by energy consumption) customers specifically on the issue of price and supply quality. The last such consultation was carried out in 2010. (Refer Section 3.1)

### **2.1.4 Energy & demand characteristics**

Key energy & demand figures for the 2010/11 year are as follows...

<b>Parameter</b>	<b>Value</b>	<b>Trend</b>
Energy conveyed	302,405GWH	Annual variations due to weather patterns. Average increase of 2% p.a.
Maximum System demand	56.404 MW	Average increase of 2% p.a. excluding strategy change over the period.
Load factor	0.60	Conveyed Units/ Maximum Demand x Hours p.a.. Decline over recent years as small transformers were replaced with minimum 30kVA.

The historical consumption p.a. shows an average 1% growth predominantly in the non domestic group. The system demand trend has been significantly influenced by a change in Load control strategy from 2001 to 2004.

Low figures for 2003/2004 were a result of the national energy crisis where advertising to control energy usage and energy retailer requests for hot-water load control beyond that usually required for peak demand control had a noticeable impact on demand. During 2010 - 2011 Global financial instability has indirectly influenced usage and growth behaviours. This may account for the decline in this period however it is difficult to determine the impact of this on the trends. Annual variation due to climate is higher than the growth hence it is not possible to make definitive conclusions on the asset utilisation trends. The steady decline in domestic energy usage is noticeable in the trend and has had an impact on energy price over the years.



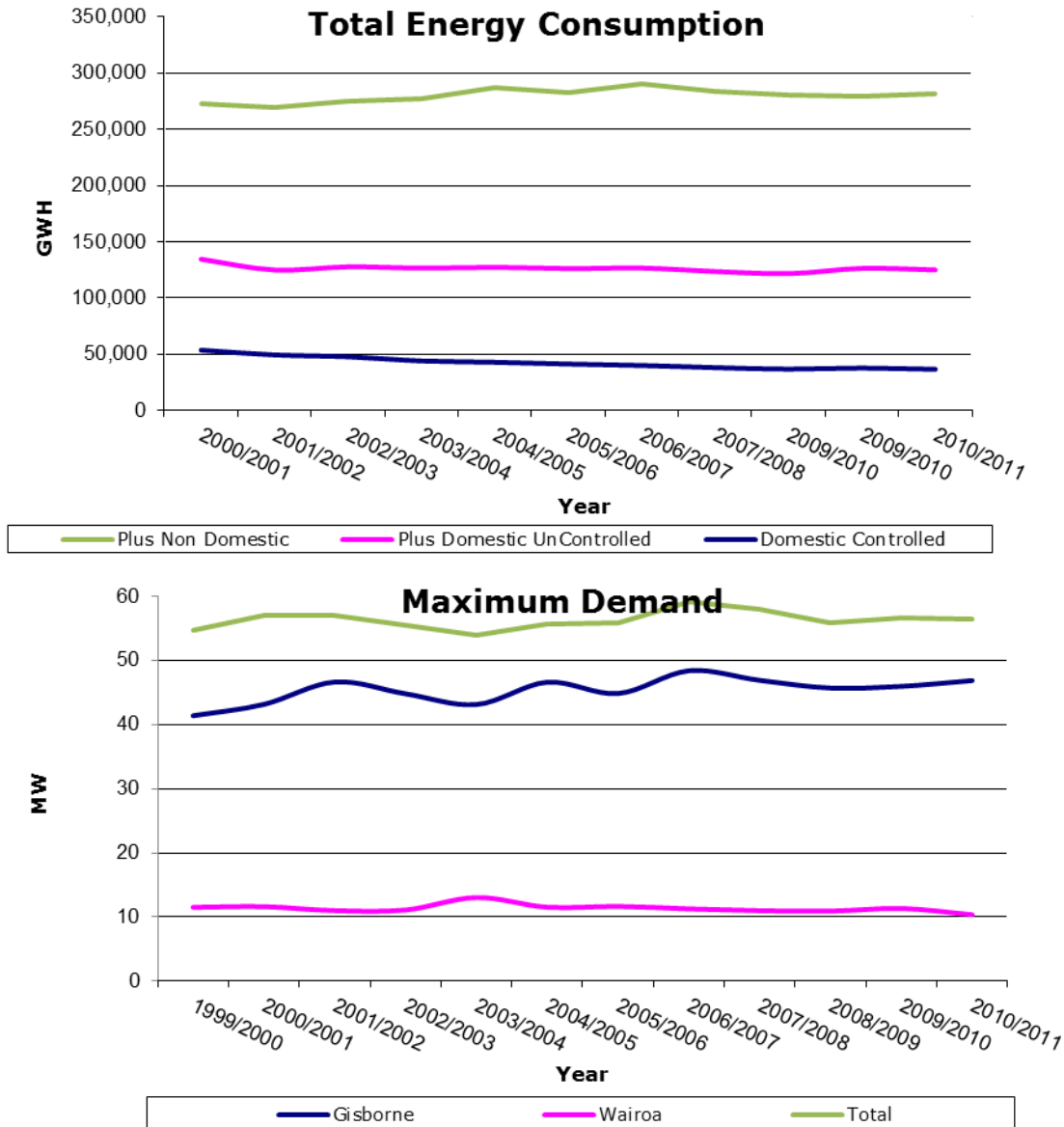

## 2.2 ENL's network configuration

To supply ENL's 25,514, (as at 01 April 2011), consumers ENL owns and operates the following three electrically separate networks which are ...

- .
- The Tuai network, 364 ICPs, which initially was part of the Wairoa EPB

ENL acquired the network and generation business of Wairoa Power Ltd in 1999. Prior to this Wairoa Power had sold its retail business to

Trust Power and Eastland Energy had sold its retail business to Contact Energy Ltd.

While ENL's three distribution networks are not connected at either the sub-transmission or distribution level, they are geographically contiguous. Network pricing, performance target setting/reporting and capital and maintenance expenditure budgeting have been consolidated since 1999. However changes to Information Disclosure requirements in 2008 now require separate reporting and target setting for the Gisborne and Wairoa regions which may affect the strategies applied in future years. Any operational separation of the networks will result in the loss of cost synergies.

## **2.2.1 Bulk supply assets & embedded generation**

### **2.2.1.1 Gisborne Region Bulk Supply**

#### **Gisborne GXP**

ENL takes supply for the Gisborne region network at Transpower's Massey Rd GXP on the northern outskirts of Gisborne. This is supplied by a double circuit 110kV tower line from Waikaremoana which splits into two double-pole under-hung circuits near Patutahi (about 7km west of Gisborne) and then re-converges into a double circuit tower configuration for about 12 spans immediately west of Massey Rd. The route length of the Tuai/Gisborne 110KV lines is approximately 95km.

Massey Rd has two 60MVA 110/50kV transformers (designated T1 and T2) which supply a 50kV bus via two 50kV incomers. The 60MVA units, installed in March 2007, replaced two 30 MVA transformers, overcoming a net maximum demand constraint.

ENL is supplied by four 50kV feeders, two on each side of the bus. Installation of Neutral Earthing resistors and on-load tap-changers and a 50kV bus upgrade were also components of the transformer upgrade. These items corrected issues identified in AMP's prior to 2007. Issues associated with the Gisborne GXP are;

- The 110kV circuits into Massey Rd are currently summer/winter rated at 49MW/60MW. Scheduled in Transpower's Annual Plan is a tactical thermal upgrade of the line. This thermal upgrade will aim to increase the summer rating of the line to 60MW.
- To meet max demand exceeding 60MW, (forecast to occur sometime between 2017 and 2030) will ultimately require the

installation of a third Tuai/Gisborne line. It is noted that Transpower's efforts to obtain an additional line easement in 2000 were not completed and easement options have now lapsed. Alternatives such as local generation and load control/demand side management will influence the timing of the third line requirement.

- The double-circuit 110kV configuration in part installed on single structures does not give true (n-1) security.
- The two 110kV circuits are supplied by a ring-bus at Waikaremoana that is coupled by a 110kV breaker. Bus zone protection was installed in 2010 reducing the risk of a bus fault at Waikaremoana tripping both 110kV lines to Massey Rd.
- ENL has no control or indication for the 50kV feeder circuit breakers which can impact on restoration response times.

### **Tokomaru Bay GXP**

Historically ENL also took supply from Transpower via a GXP at Tokomaru Bay which was supplied by a 110kV single-circuit tower line from Massey Rd. However ENL relinquished supply from this GXP in 2000 and instead supplies this area from its own 50kV sub-transmission network and secures supply with its own diesel generators as required.

The 110kV line is currently left energised to provide capacitive voltage support for Massey Rd but is disconnected at Tokomaru Bay by an open 110kV incoming isolator. The transformers from the site have been removed and jumpers installed to bridge the 110kV line to the 50kV line. ENL's 50kV sub-transmission network is isolated from the GXP 110kV line by the open isolator on the 110kV and an open isolator on the 50kV lines. It is feasible to disconnect the 110kV line and jumper the line to the 50kV network at the Gisborne end as a contingency strategy.

### **Diesel Generation**

ENL uses five 1MW and one 0.5MW diesel generators which are owned by Eastland Generation Limited. The units are housed in standard shipping containers and weigh about 23 tons each. These can be deployed anywhere in the network that is accessible to a large mobile

crane and where up to 1MW can be injected at 11kV with the energy being sold to Contact Energy.

Benefits derived from operating these generators include...

- Reduction of ENL's max demand at GXP's by anything up to 5MW (using ENL's load control can relieve a further 3-4MW).
- Easing of constraints on ENL's network, thereby avoiding network investment that would only be required for short periods.
- Providing localized continuity of supply during outages due to sub-transmission faults or as required facilitating network maintenance.
- Provision of alternative transmission to meet the requirements of grid emergency procedures.

The 1MW generators are located at Matawhero, Puha, Ruatoria, Te Araroa, Tolaga and Mahia on a semi-permanent basis. The 0.5MW unit is also used as required to maintain customer supply during planned and/or unplanned outages. Upgrading of the 0.5MW unit's 400V circuit breaker, starting system and 11kV connecting leads was completed in 2006/07 full synchronizing capability was installed in 2008 and the AVR was upgraded in 2010.

**Private Embedded Generation**

A 2x1MW induction Hydro generation facility was installed in 2009. This facility owned and operated by Clearwater Hydro Ltd depends on adequate river flows over a weir and is located in the Matawai area. To date this facility has delivered no benefits to the network in the local area.

**Backup Generation**

Generation in the region that is capable of being operated on a standby basis (ie during power outages) but is not connected to the network is in common use throughout the region.

While there is no mandate or systems in place to obtain information on generation of this type the known sites include...

- |                             |               |
|-----------------------------|---------------|
| • Gisborne waterworks       | -1MVA,200kVA  |
| • Gisborne Sewage outlet    | -200kVA,30kVA |
| • Sewage Treatment Gisborne | -1MVA         |
| • Emerald Hotel             | -300kW        |
| • Gisborne Hospital         | -500kVA est   |
| • Gisborne Airport          | -5kVA         |

- Gisborne Exchange -200kVA est
- Eastland Group -14KVA

In addition an estimated 15% of rural connections have access to petrol generators, 1 to 3 kW, for use during power outages.

### **Proposed Generation**

ENL believes that in part a solution to regional transmission constraint is the development of additional embedded generation throughout its distribution network. The following generation possibilities have been identified;

- Medium scale, (80MW) hydro generation
- Small scale , (70-2000KW) hydro generation
- Bio-mass fuelled combined heat & power plants
- Gas-fired cogeneration plants.
- Wind Generation
- Gas engines

Eastland Groups Energy sector Business Plan contains initiatives to investigate the feasibility of the above potential generation and develop those projects as appropriate.

In September 2008, Government passed the Electricity Industry Reform Amendment Bill under urgency in the House. This was the culmination of review of the EIRA designed to relax the rules regarding ownership and operation off generation by Lines Companies. A key part of these changes were changes to the restrictions on renewable energy sources. Renewable energy sources are defined as:

*solar, wind, hydro, geothermal, biomass, tidal, wave, ocean current sources, or any other energy source that occurs naturally and the use of which will not permanently deplete New Zealand's energy sources of that kind, because those sources are generally expected to be replenished by natural processes within 50 years or less of being used.*

While clearly this has relaxed the rules regarding the amount of generation a lines company can own, in particular renewable

generation and generation outside its geographic area, arms length rules still apply to a lines company with generation and retail functions as shown in the table below:

		Electricity Lines Company	
		Generation Division	Retail Division
<b>Renewable Generation</b>	In region	Unlimited	<ul style="list-style-type: none"> <li>• Information separation</li> <li>• &gt;10MW:                             <ul style="list-style-type: none"> <li>○ Separate Co.</li> <li>○ Separate Board</li> </ul> </li> <li>• &gt;30MW                             <ul style="list-style-type: none"> <li>○ Separate Co.</li> <li>○ Separate Board</li> <li>○ Separate Mgt</li> </ul> </li> </ul>
	Outside region	Unlimited	
<b>Non-renewable Generation</b>	In Region	50MW or 20% of max demand	
	Outside Region	Unlimited	

The remaining restrictions, specifically those regarding the arms-length rules, could be a significant impediment to the development of generation/retailing opportunities.

Ultimately, each Generation Opportunity must be assessed against the criteria of creation of Shareholder value and regional prosperity before the decision to proceed is made. While this is can be subjective in terms of regional prosperity, all projects will be assessed on a Discounted Cash Flow basis, that incorporates all project costs and revenues, and only those projects which are expected to have a positive Net Present Value against a hurdle rate that is deemed acceptable for the project will proceed.

However, based on Eastland Network's previous experience, a key factor to the success of these projects is the ability to retail. As discussed above, the changes to the EIRA still present significant challenges and restrictions on the ability to retail. This may significantly undermine the value of many generation opportunities.

### **2.2.1.2 Wairoa bulk supply**

#### **Wairoa GXP**

Supply to the Wairoa GXP is by a double-circuit 110kV line from Waikaremoana.

The GXP comprises two 10MVA 110/11kV transformers and an 11kV board comprising two incomers, a bus tie and six feeders. Since ENL rationalised its supply configuration in 2002 only 2 of the 6 feeders are used. ENL also owns and operates a 12.5MVA 11/33kV step-up substation adjacent to the Wairoa GXP to supply the Mahia Peninsula at 33kV. The installation includes a 33kV CB and pole-mounted 11kV breaker. A load control plant injecting at 11kV is also located at the site.

Issues at this site include...

- Six switch panels on the Transpower 11kV board are currently surplus to ENL's requirement.
- The initial 40m of each of the 2 outgoing 11kV feeders consists of cable that is limited to 8MW.
- There is potential for between 20MW and 40MW of gas-fired generation near Frasertown.
- The proximity of the 50kV line from ENL's Waihi power station to ENL's Kiwi substation lends itself to rationalising the whole supply to both Wairoa and Mahia.

#### **Tuai GXP**

ENL has approximately 600kVA of load in and around Waikaremoana which is supplied by a 10MVA 110/11kV transformer and two KFE reclosers. These reclosers were installed in 2000, and are fitted with Transpower SCADA controls.

Previously ENL has investigated obtaining an alternative to the existing Transpower supply which is disproportionately expensive to maintain. Options considered include...

- Building a line to Waikaremoana from the end of the existing Wairoa 11kV network which comes within about 1km of Waikaremoana. This was given some detailed consideration but is a very high cost option to supply only 600kVA because of the 11kV reinforcement/upgrade required all the way from Wairoa. It is also considered that consent and/or easement issues associated with this option would be considerable.  
A variation to this option could include converting the 50kV Waihi line to 33kV and provide a 6.6/11/33kV transformer at Waihi. This option will be further investigated when the Wairoa development plan is implemented.
- Taking an 11kV supply straight from the generation bus at Tuai. This option was discounted due loss of supply issues associated with planned and unplanned generation bus outages.

### **Generation**

A 5MW hydro station at Waihi is owned by Eastland Generation Limited. This facility is effectively limited to peak chopping by the limited water storage. The generator is embedded in ENL's network and supplies a 50kV line to ENL's Kiwi substation via a 6.3MVA 6.6/50kV transformer. The generation from Waihi is sold to TrustPower.

ENL uses six 1MW and one 0.5MW diesel generators which are owned by Eastland Generation Limited. The units are housed in standard shipping containers and weigh about 23 tons each ENL also uses one of its 1MW diesel generators to support demand at Mahia over Christmas and Easter until the Mahia 33kV extension is completed.



## **2.2.2 Sub-transmission network**



### **2.2.2.1 Gisborne Region sub-transmission**

The Gisborne Region sub-transmission network comprises the following asset configurations...

- A 50kV spur from Massey Rd up the east coast that was originally constructed by the NZED as far as Tokomaru Bay (1955) then to Ruatoria (1964) and finally to Te Araroa (1971). Ownership of the Massey Rd – Tokomaru section of this line was transferred to the PBEPB in 1980 when the NZED completed its own 110kV tower line. A switching station at Goodwin Rd was installed to prevent faults on the Massey Rd - Tokomaru 50kV line from causing tripping of the 50kV circuit to Kaiti and the Port. This consists of a SCADA-controlled circuit breaker with an associated isolator/earth switch and fence enclosure. It was constructed in 2002.
- Two 50kV lines from Massey Rd to Makaraka.
- A single open 50kV ring to the west of Gisborne supplied from half way along one of the Makaraka lines at the Hexton switching station to supply 50/11kV substations at Puha, Ngatapa, Pehiri, Patutahi and back to Makaraka. Between Puha and Ngatapa there is a 50kV spur supplying Matawai which operates at 11kV. The Hexton switching station was installed as part of the project to construct the second 50kV line into Makaraka from the Massey Rd – Puha circuit in 2001 to prevent faults in the Puha–Ngatapa-Pehiri-Patutahi segment of the 50kV ring from affecting supply to Makaraka, Matawhero and Parkinson St.

- Two 50kV urban rings, one supplying 50/11kV substations at Kaiti, Carnarvon St and the Port from Massey Rd, and the other supplying Matawhero, JNL and Parkinson from Makaraka. These rings can be connected between Carnarvon and Parkinson which occurs regularly to enable maintenance of Transpower assets on the 50kV structures at Massey Rd without loss of supply.

These are depicted in Figure 2.2.2.1 below....

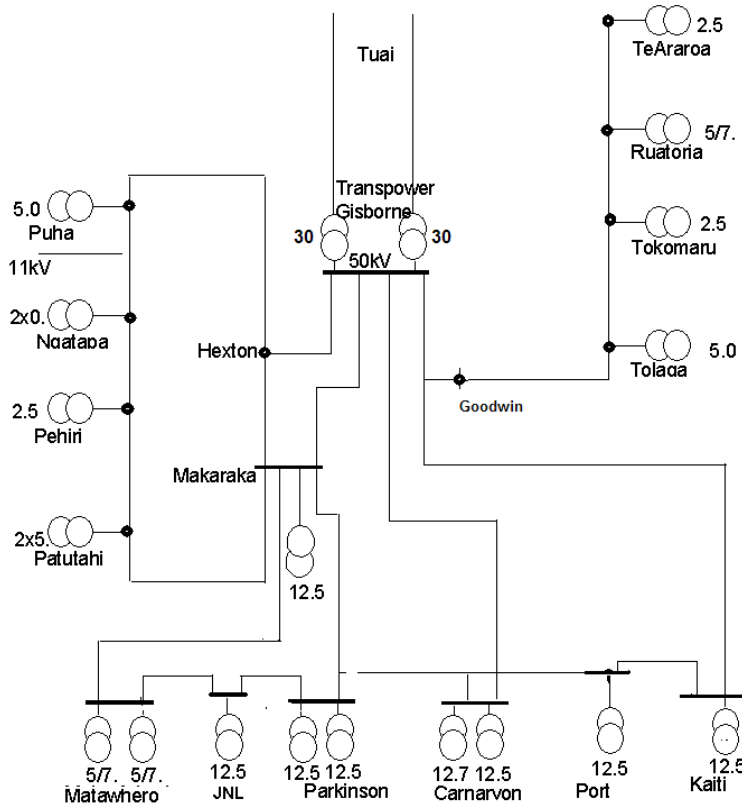

### 2.2.2.2 Wairoa sub-transmission

The Wairoa sub-transmission network comprises two main components...

- A 33kV line stretching 35km from ENL's 11/33kV step-up substation adjacent to the Wairoa GXP to ENL's Blacks' Pad substation at the north end of the Mahia peninsula. Prior to 2000 this line was operated at 50kV despite parts of the line being only insulated to 33kV.
- A 50kV line from Waihi hydro to ENL's Kiwi substation which includes some under-built 11kV in places.

Figure 2.2.2.2 below depicts the Wairoa sub-transmission network...

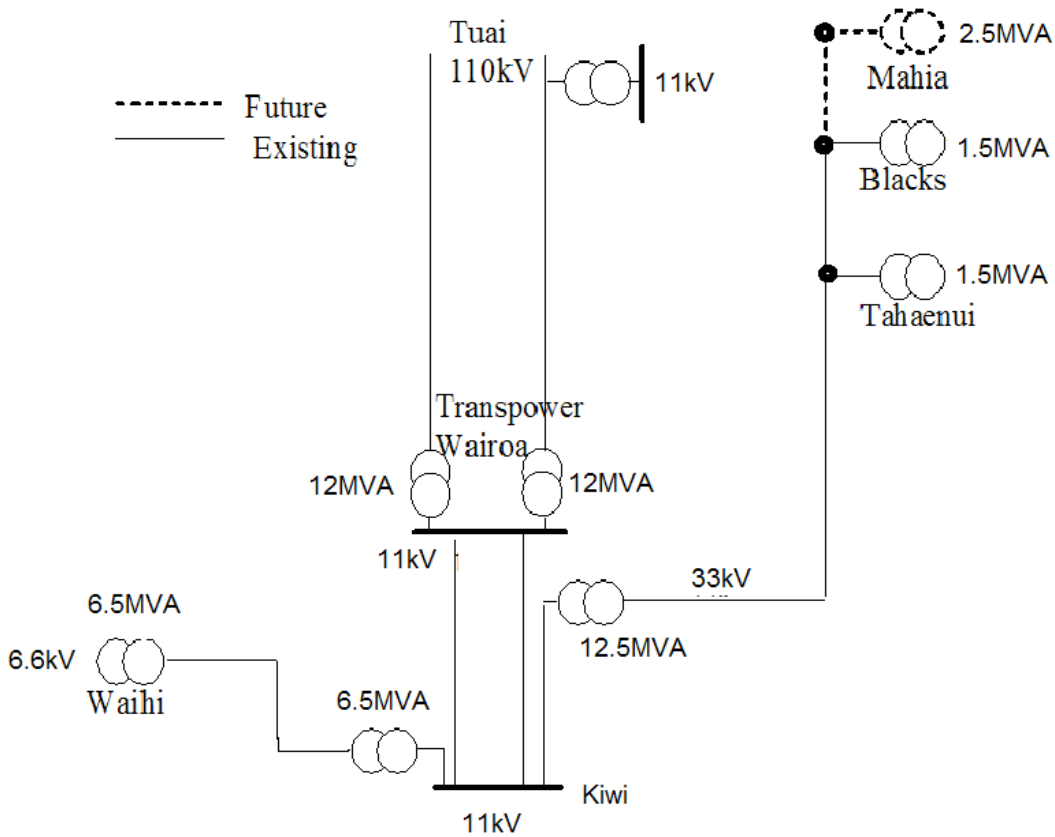

The following table summarises the lengths of the various classes of Subtransmission lines

Class	Voltage	Length Gisborne (m)	Length Wairoa (m)	Total length (m)
OH EHV 50kV & 33kV	50 kV	300466.3139	268106.11	32360.2
UG EHV 50kV & 33kV	50 kV	1344.625	1344.625	0
OH EHV 50kV & 33kV	33 kV	34322.6	0	34322.6
UG EHV 50kV & 33kV	33 kV	65.236	0	65.236

### 2.2.3 Zone substations



#### 2.2.3.1 Gisborne Region Substations

ENL's Gisborne region substations are summarised in the following table and described more fully by the following narratives.

Sub.	Area supplied	Description
Carnarvon	CBD and central Gisborne.	Substantial two transformer urban sub.
JNL	Primarily supplies a single large consumer, likely to supply additional similar customers in the medium-term.	Single transformer industrial sub with provision for a second transformer.
Kaiti	Residential Kaiti area, some load being shifted to Port.	Substantial single transformer urban sub with provision for second transformer.
Makaraka	Semi-rural Makaraka area immediately west of Gisborne.	Substantial rural single transformer sub, also provides significant switching point for the 50kV ring and also for ripple injection.
Matawhero	A number of large produce processing consumers about 8km west of Gisborne.	Substantial two transformer industrial sub.
Ngatapa	Rural Ngatapa area and surrounding district about 30km west of Gisborne.	Minimalist single transformer rural sub.
Parkinson	Industrial estate in south-west Gisborne.	Substantial two transformer urban sub.
Port	Port area of Gisborne including taking residential load from Kaiti and CBD load from Carnarvon.	Substantial single transformer urban sub.
Patutahi	Semi-rural area around Patutahi about 18km west of Gisborne.	Minimalist rural sub with two banks of three 1-phase transformers.
Pehiri	Rural area around Pehiri about 30km west of Gisborne.	Single transformer rural sub.

Puha	Mountainous rural area around Te Karaka, Whatatutu and Matawai about 40km north-west of Gisborne.	Three 1-phase transformer substantial rural sub supported by 1MW of diesel generation.
Ruatoria	Small settlement of Ruatoria and surrounding district about 90km north of Gisborne.	Substantial single transformer rural sub supported by 1MW of diesel generation.
Te Araroa	Small settlement of Te Araroa and surrounding district about 115km north of Gisborne.	Substantial single transformer rural sub supported by 1MWe of diesel generation.
Tokomaru	Small settlement of Tokomaru By and surrounding district about 60km north of Gisborne.	Substantial single transformer rural sub.
Tolaga	Small settlement of Tolaga Bay and surrounding district about 35km north of Gisborne.	Substantial three 1-phase transformer rural sub supported by 1MW of diesel generation.

### **Carnarvon St**

Supply to Carnarvon is as follows...

- A single 50kV line from Massey Rd.
- A teed 50kV line from the Port that can connect to Parkinson.

The 50kV bus at Carnarvon includes a 50kV circuit breaker allowing operation as a closed ring. There are two 3-phase 50/11kV 12.5MVA transformers, each 50% loaded and an 11kV board comprising 2 incomers, a bus tie and 9 feeders.

There are no outstanding issues at the site

### **JNL**

The JNL substation was constructed in 2005. The 11kV switchboard was livened mid 2005 and supplied load to JNL via a 50kV line from Matawhero operating at 11kV. The completion of this substation allows surplus capacity at Matawhero to be used to supply significant industrial load increases, (i.e. wood processing plants) forecast to be required within the next 3 years.

The substation comprises...

- A 50kV Line from Matawhero Substation

- A 50kV line from Parkinson St substation, completed in 2006/07
- A 50kV bus CB to allow closed 50kV ring operation
- 1 3-phase 12.5MVA transformer bank with room for a second transformer
- A Portacom switch room housing an 11kV Reyrolle switchboard with 1 incomer, 2 feeders, a fuse switch for local service and a bus coupler for future extension or generator connection.

There are no outstanding issues at the site

### **Kaiti**

The Kaiti area was originally supplied at 11kV directly from Massey Rd, but by the mid-1980's this load could no longer be adequately supplied at 11kV so in 1987 the PBEPB built a new substation. Kaiti now comprises...

- An incoming 50kV line from Massey Rd.
- An outgoing 50kV line to the Port.
- A minimum oil 50kV circuit breaker providing incoming protection for the transformer and a 50kV bus breaker for closed ring operation.
- A single 12.5MVA 50/11kV transformer (with provision for a second transformer).
- An 11kV Reyrolle board with 2 incomers, a bus tie, a fuse switch and 7 feeders.

Key issues at Kaiti are...

- The close proximity to houses means that transformer noise is a potential issue which is exacerbated by the high impedance of the transformer. Some form of noise reduction fencing may be required in the future.
- Vandalism issues resulting in insulator damage and an accumulation of debris at the site may drive the need to enclose the transformer.

- The #1 incomer cables have failed in service and the transformer currently supplies load via incomer #2. Replacement of the #1 incomer cables will be required if a second transformer is ever installed at the site.

### **Makaraka**

Makaraka was originally constructed in 1974 as a switching point for the Massey Rd - Patutahi 50kV line which also teed off to Carnarvon. A second incoming 50kV line from Massey Rd, which has been tapped off the Massey Rd - Puha line, was built in 2001. At time Makaraka was upgraded from a switching station to a single transformer zone substation by the installation of a new 12.75MVA transformer.

Makaraka now comprises...

- Two incoming 50kV lines from Massey Rd (one via Hexton).
- A 12.5MVA 50/11kV transformer capable of running off either side of a split 50kV bus.
- A Portacom switch room with an 11kV board comprising an incomer, 4 feeders and a fuse switch.
- A 50kV load control injection coupling cell (outdoor).
- A hut containing a load control static converter.
- Three outgoing 50kV circuits to Patutahi, Matawhero and Parkinson.

There are no outstanding issues at the site

### **Matawhero**

ENL built Matawhero in 2000 as a single transformer substation primarily to supply JNL because the existing 11kV cables from Parkinson had become inadequate (although they have been left in situ to provide additional security of supply). In 2003 ENL augmented Matawhero with a second transformer, a second 50kV breaker and two additional 11kV feeders to supply the rapidly growing cold storage load in this area. Matawhero now comprises...

- An incoming 50kV line from Makaraka.

- An outgoing 50kV line to the new JNL substation.
- A 50kV bus circuit breaker to allow 50kV operation as a closed ring.
- Two 5/7.5MVA 50/11kV transformers.
- A Portacom switch room with an 11kV board comprising two incomers, a bus coupler, five feeders and a fuse switch. The bus rating at 11kV is 800A

The key issue at Matawhero is the proximity of a major river. This substation is located in an area that is likely to have large industrial load growth which may require capacity upgrades of the 7.5MVA transformers to 12MVA with a corresponding upgrade of the 11kV switchboard to 1250A

### **Ngatapa**

The PBEPB built Ngatapa in 1964 as part of closing the 50kV ring between Puha and Patutahi. In 2008 the two 500kVA transformers and outdoor 11kV bus were replaced eliminating previous issues associated with the site. Ngatapa currently consists of...

- An incoming and an outgoing 50kV line forming the 50kV ring from Makaraka to Hexton (which also supplies the Patutahi, Pehiri and Puha Substations).
- One 2500kVA 50/11kV transformer. An 11kV regulator is used to regulate voltage for the backup supply via Patutahi.
- A Portacom switch room with an 11kV Reyrolle switch-board comprising one incomer, three feeders and a fuse switch.

Ngatapa substation has also been identified as an alternative supply to Matawai and some support to Puha. To achieve this an 11kV line would need to be upgraded along Hihiroroa Rd then extended under the 50kV line to the top of Otoko Hill with dog conductor.

There are no outstanding issues at the site.

### **Parkinson**



The industrial load in and around Parkinson St was originally supplied at 11kV from Massey Rd (similar to the domestic load in Kaiti) which was no longer adequate by the mid-1980's. In 1987 the PBEPB built a zone substation in Parkinson St in an identical configuration to Kaiti. In 2004 a second transformer was added at Parkinson St.

Parkinson currently takes supply from a tee off the Makaraka – Carnarvon 50kV line and is also connected to the new JNL dedicated substation via a 50kV line. Parkinson currently comprises...

- Two 12.5MVA 50/11kV transformers. The first was installed in 1987 and the second is the former Carnarvon T1 that was refurbished and installed in 2004.
- A 50kV bus breaker to allow operation as a closed ring.
- An 11kV Reyrolle board with 2 incomers, a bus tie, a fuse switch and 7 feeders.
- An SF6 RMU connected to one of the feeders to provide for the local service supply transformer.

There are no outstanding issues at the site.

### **Port**

Port was completed in December 2003 to enable continued load growth at Kaiti and for Carnarvon to be off-loaded. This provided security provision for the Kaiti area. Port currently comprises,

- An incoming 50kV line from Kaiti.
- A second 50kV line from Carnarvon.
- A 50kV bus breaker to allow operation as a closed ring.
- A 12.5MVA 50/11kV transformer.
- An 11kV Reyrolle board with an incomer, a fuse switch and 4 feeders.

There are no outstanding issues at the site.

## **Patutahi**

Patutahi was built in 1929 by the State Hydro Electric Department as the main bulk supply point to the Gisborne area. The following upgrades have taken place over the years....

- The original transformers were replaced with other ex-NZED transformers dating from the 1940's.
- The original brick building was considered an earthquake risk and was replaced in 1991.
- The original 11kV board was replaced in 2000 with second-hand Reyrolle LMT panels and new VCB's.
- The 50kV air operated breakers were replaced in 2006.

Patutahi now comprises...

- An incoming 50kV line from Massey Rd via Makaraka.
- An incoming 50kV line from Massey Rd via Makaraka, Hexton, Puha, Ngatapa and Pehiri.
- A 50kV line breaker for isolating faults from Pehiri.
- Two banks of 50/11kV 1.67MVA 1-phase transformers. There are also two spares, one of which has failed in service and is considered uneconomic to repair.
- A single 11kV incomer, four feeders and one fuse switch.
- An outdoor structure consisting of mostly steel lattice and concrete poles with copper wire bus bar.

The key issues at Patutahi are mainly that the original design standards for earthing, construction, drainage and oil containment have been overtaken by modern standards. These will be addressed as part of a planned conversion of Patutahi to a single transformer substation that will be secured by off-loading capacity to Matawhero and Makaraka.

## **Pehiri**

The PBEPB built Pehiri in 1964 along with Ngatapa as part of the 50kV ring extension from Puha to Patutahi. ENL upgraded Pehiri in 1998 to include a 2.5MVA transformer with an on-load tap changer. If this transformer needs to be removed from service ENL can supply most of Pehiri's load via the 11kV from Patutahi and using an old 11kV regulator at Pehiri to boost the voltage.

Previous issues were corrected in 2011 by installation of a new 50KV CB on the Transformer and removal of the old 50kv line CB

Pehiri now comprises...

- An incoming and an outgoing 50kV line which forms part of the 50kV ring from Makaraka to Hexton.
- A 2.5MVA 50/11kV transformer.
- An 11kV voltage regulator.
- An 11kV incomer and four 11kV feeders on an outdoor bus.

There are no outstanding issues at the site.

### **Puha**

The PBEPB built Puha in 1960 to supply the Te Karaka, Whatatutu and Matawai areas to the north-west of Gisborne. Originally Puha was supplied by a single 50kV line from Massey Rd, but in 1963 Puha was given a second supply when the 50kV ring was closed. Since the original construction ENL has done the following upgrades...

- Earthing and transformer bunding upgrades.
- Replacement of the outdoor 11kV bus and breakers with an ABB Safeplus SF<sub>6</sub> indoor board.
- Installation of a new 50kV Merlin Gerin SF<sub>6</sub> breaker on T1.

Puha currently comprises...

- An incoming and an outgoing 50kV line forming the 50kV ring from Makaraka to Hexton.
- Three 1.67MVA 50/11kV 1-phase transformers.

- An 11kV board comprising a single incomer, a fuse switch and four feeders.
- One of ENL's 1MW diesel generators to augment the limited transformer capacity for which an RMU is being installed.

Key issues with Puha are...

- Max demand cannot be fully off-loaded to other substations via the 11kV. In addition to operating one of ENL's 1MW diesels at Puha, this is also being addressed by providing for Matawai to be supported via an upgrade at Ngatapa, extending the Ngatapa feeder to Otoko Hill and possibly reinforcing the Lavenham feeder from Patutahi.
- There is no oil separation capability, and any work on this has been deferred to coincide with replacement of the transformer bank.

### **Ruatoria**

The PBEPB built Ruatoria in 1965 to supply the wider Ruatoria area including Wahareponga, Kopuaroa and Whakawhitira. Over the last decade ENL has upgraded Ruatoria as follows...

- In 1998 ENL installed two refurbished MetroVick 50kV bulk oil breakers, a new 50kV bus and four new SF<sub>6</sub> pole-mounted 11kV breakers.
- In 1999 ENL installed a new 5/7.5MVA 50/11kV transformer and upgraded the bunding, and also did some earthing upgrades.
- In 2001 ENL replaced the four pole-mounted 11kV breakers with an indoor Safeplus SF<sub>6</sub> board in a Portacom. This enabled removal of the outdoor 11kV structure and reduction of the yard size as well as improving the earthing and yard surface.
- In 2011 ENL Replaced one of the MetroVick 50kV bulk oil breakers

Ruatoria currently comprises...

- An incoming 50kV line from Tokomaru Bay.
- A 5MVA 50/11kV transformer.

- An 11kV board comprising a single incomer, a fuse switch, three feeders and a generator connection point.
- A 1MW diesel generator.

There are no outstanding issues at the site.

### **Te Araroa**

The PBEPB built Te Araroa in 1971 to supply the wider Te Araroa area including Hicks Bay, Horoera and Awatere Valley. Recent upgrades include...

- In 1998 ENL replaced the original 11kV switchgear with second hand Reyrolle LMT panels and new VCB's and also installed a 2.5MVA transformer with an on-load tap changer with bunding and oil containment facilities.
- In 2001 ENL installed a MetroVick 50kV bulk oil breaker on the transformer and removed the earth throw switch originally used for transformer protection. The voltage regulator that was used for security was also removed after it failed in service.
- In 2011 ENL Replaced one of the MetroVick 50kV bulk oil breakers

Te Araroa currently comprises...

- A single incoming 50kV line from Ruatoria.
- A single 2.5MVA 50/11kV transformer.
- An 11kV board comprising a single incomer, a fuse switch, three feeders and a generator connection point.
- A 1MW diesel generator.

There are no outstanding issues at the site.

### **Tokomaru Bay**

The PBEPB built Tokomaru in 1958 adjacent to the Transpower GXP to supply the surrounding area including Te Puia Springs and Mawhai

Point. Since the original construction ENL has upgraded Tokomaru as follows...

- In 1998 ENL installed a new 2.5MVA transformer with an on-load tap changer and bunding. ENL also upgraded the earthing at the same time.
- In 1999 ENL replaced the 11kV switchgear with a second hand Reyrolle LMT board with new VCB's.
- In 2001 an oil separator was added.
- In 2011 ENL Replaced one of the MetroVick 50kV bulk oil breakers

Tokomaru currently comprises...

- A single incoming 50kV line from Tolaga Bay.
- A single outgoing 50kV line to Ruatoria.
- A single 2.5MVA 50/11kV transformer.
- An 11kV board comprising a single incomer, a fuse switch and three feeders.
- A single 50kV connection to Transpower's Tokomaru Bay GXP (from which ENL relinquished supply in 2000).

There are no outstanding issues at the site.

### **Tolaga Bay**

The PBEPB built Tolaga Bay in 1963 to supply the surrounding area including Hauti and Wharekaka. Since the original construction ENL has upgraded Tolaga as follows...

- In 2000 ENL installed a MetroVick 50kV bulk oil breaker to provide transformer protection. The earthing for the remaining substation yard was upgraded as part of the project.
- In 2001 ENL undertook a significant rationalisation that included erecting a switch-room and installing an indoor Safeplus SF<sub>6</sub> board,

removing and scrapping the spare 50/11kV transformer, removing the out-dated 11kV outdoor bus and halving the size of the yard.

Tolaga now comprises...

- A single incoming 50kV line from Goodwin Rd switching station.
- A single outgoing 50kV line to Tokomaru.
- A 5MVA 50/11kV bank comprising three 1.67MVA transformers and a spare.
- An 11kV board comprising a single incomer, a fuse switch and four feeders.
- A 1MW diesel generator.

Key issues at Tolaga include...

- There is currently no oil separation. Installation has been deferred to coincide with replacement of the transformers.
- All but 300kVA of load can be back-fed from adjacent substations on the 11kV. The remaining 300kVA can be adequately supported by the diesel generator.

### 2.2.3.2 Wairoa Region Substations

ENL's Wairoa substations are summarised in the following table and described more fully by the following narratives...

Sub.	Area supplied	Description
Blacks Pad	Opoutama, Kaiwaitau and the Mahia peninsula.	Minimalist single transformer rural sub supported by 1MWe of diesel generation over Christmas and Easter.
Kiwi	Urban Wairoa including AFFCO plant.	Substantial switching station supplied at 11kV from Transpower and houses the 50/11kV step-down transformer for the Waihi line.
Tahaenui	Semi-rural area around Nuhaka and Morere, also back-feeds to Blacks Pad.	Minimalist single transformer rural sub.
Waihi	Step-up substation at 5MW hydro	Minimalist single transformer sub.

	station.	
--	----------	--

### **Blacks Pad**

Blacks Pad is located at the north end of the Mahia peninsula. Initially the substation included three 50/11kV single-phase transformers totaling 5MVA supplied by a 50kV line from Wairoa. In 2000 the 50kV line was formally converted to 33kV to improve reliability and the transformer replaced with a single 1.5MVA 3-phase transformer. Other equipment includes 33kV drop-out fuses and an 11kV pole-mounted circuit breaker. Bunding, fencing and earthing upgrade work was all completed in 2000 in conjunction with the transformer change. The transformer does not have on-load tapchanger capability.

A key issue with Blacks Pad is that the Christmas and Easter load at Mahia often exceeds the 1.5MVA transformer rating which has been relieved by operating one of ENL's diesel generators at Mahia beach. Loading in general at Mahia is increasing in conjunction with beach front subdivisional activity and as more holiday homes become permanent residences.

Development actions include the Mahia 33kV extension project which will address future Mahia load increases issues. In 2008 due to potentially permanent delays in easement negotiations the extension project was deferred. As a result no new load can be connected to the existing lines in the area. In addition as load disconnects reconnection is not permitted until the load can be supported by the network without the need for the generator.

### **Kiwi**

Kiwi was built as part of the Waihi hydro station in 1983 and takes supply as follows...

- Via a 6.3MVA 50/11kV transformer from Waihi.
- Via two 11kV feeders from the Wairoa GXP.

The 11kV board includes two incomers, a bus tie and seven out-going feeders. Key issues with Kiwi include...

- The risk of minor flooding which happens occasionally and places supply to almost the entire Wairoa network at risk. Stop logs are installed at the doorways to the switch-room to reduce this risk.



- Oil capture and separation facilities would be required for the 50/11kV transformer but this transformer will be removed as part of a long term 33kV development plan.

### **Tahaenui**

Tahaenui was built in 2001 and is located between Wairoa and Blacks Pad and comprises incoming 33kV drop out fuses, a 1.5MVA 3-phase transformer with manual tap settings, a pole mounted 11kV circuit breaker and an 11kV RMU. Tahaenui is used primarily to supply Morere and also provide limited 11kV back-feeding capability to Blacks Pad.

There are no current issues with Tahaenui.

### **Waihi power station**

Waihi Power Station is a 5MW hydro power station located off the highway between Frasertown and Tuai. Assets at the site that come within the scope of this AMP include the 6.3 MVA 6.6/50kV transformer and the 50kV line from Waihi to Kiwi. The transformer installation includes oil separation facilities. Manual rest trip relays were replaced with remote reset devices in 2010.

Waihi is potentially ideally located to provide an 11kV supply to the immediate area and also back feed into the far ends of the Raupunga and Frasertown 11kV feeders. Plans have been developed to rationalise the 50kV line and 6.6/50kV transformer at Waihi with distribution assets solving a number of development issues.

A key issue with Waihi is that any transformer tripping will activate a phase to phase 50kV throw switch to isolate the 50kV line between Waihi and Kiwi.

#### **2.2.3.3 Substation Security**

The levels of security that are applicable to each substation depend on the size of the load supplied by the substation. The security levels applicable and impacts of future load for each substation is provided in section 4.2.2.4.

The methods to achieve the current zone substation security levels are as follows...

**Zone Substation Support Capacity**

Location	% Load Support	Security/Contingency Method
Te Araroa Sub	100%	Generator 100% or Ruatoria 30% via 11kV
Ruatoria Sub	100%	Generator 100% or TeAraroa 30% and Tokomaru 35% via 11kV
Tokomaru Bay Sub	100%	Ruatoria 50% and Tolaga 50% via 11kV
Tolaga Bay Sub	100%	Generator 100% or Tokomaru Bay 40% and Kaiti 40%
Kaiti Sub	100%	Load supplied from Port Substn and Carnarvon St via 11kV
Carnarvon Sub	100%	Dual Transformers or Port 50% and Parkinson 50%
Parkinson Sub	100%	Dual Transformers or Carnarvon 50% ,Matawhero 20% and Makaraka 30%
Makaraka Sub	100%	Carnarvon 50% ,Matawhero 20% Patutahi 10% & Parkinson 20%
Patutahi Sub	100%	Matawhero 50%, Pehiri 20%, Makaraka 20% and Puha 10%
Pehiri Sub	100%	Patutahi 100% (Uses Voltage Regulator)
Ngatapa Sub	100%	Patutahi 100% (Uses Voltage Regulator)
Puha Sub	100%	Generator 80% and Makaraka/Patutahi 20%
Matawhero Sub	100%	Dual Transformers or JNL 100%
Port Sub	100%	Carnarvon 50% and Kaiti 50%
JNL Sub	100%	Matawhero 100%
Kiwi Sub	100%	Waihi 50% or Dual supplies at 11kV
Blacks Pad Sub	100%	Generator 100%
Tahaenui Sub	100%	Kiwi Sub 100%

**2.2.3.4 Substation Demand**

The current and future demand predictions for each substation are provided in section 4.3.4.2.

**2.2.4 Distribution network**



### **2.2.4.1 Coverage**

ENL's distribution network is clustered mainly along the east coast from Te Araroa in the north to Raupunga in the south-west. Isolated inland areas such as Matawai tend to be fed by spur lines that traverse rugged uninhabited areas. The distribution network is solely 11kV (no 6.6kV or 22kV) and comprises the following...

	Gisborne	Wairoa	Total
3 Phase Overhead	1652871 m	666069 m	2318940 m
1 Phase Overhead	69280 m	17347 m	86628 m
Underground	114766 m	17577 m	132344 m

Note the above lengths exclude 374109 m of privately owned overhead line and 4209 m of privately owned underground cable.

### **2.2.4.2 Configuration**

In rural areas the configuration is predominantly radial with only some meshing between feeders and between adjacent zone substations. A high degree of meshing exists in the urban Gisborne and Wairoa areas via either ABS's or RMU's.

### **2.2.4.3 Construction**

ENL's network construction differs between rural and urban as follows...

- Rural areas are predominantly wooden pole, flat construction with wooden cross-arms and pin insulators.
- Urban areas are predominantly concrete pole with wooden cross-arms.
- Cable network is concentrated in the CBD and newer subdivisions.

ENL's past standard of 11kV line construction uses a range of conductors as shown in the following table. Copper conductors used historically are progressively substituted with Aluminium conductors for new construction. Galvanised steel conductors are still used for large spans.

Conductor Type	Length km	% Population
7/14 Cu OH	507.34	21%
7/16 Cu OH	434.05	18%

7/16 St OH	373.06	16%
3/12 St OH	240.71	10%
Gopher OH	154.58	6%
Ferret OH	139.10	6%
Dog OH	124.96	5%
Rango OH	54.01	2%
19/14 Cu OH	46.20	2%
Raccoon OH	43.49	2%
19/16 Cu OH	37.16	2%
Weke OH	35.11	1%
No 8 Cu OH	28.99	1%
Magpie OH	27.19	1%
7/.118 Cu OH	24.98	1%
7/.093 Cu OH	19.57	1%
Flounder OH	17.33	1%
Shrike OH	14.45	1%
Robin OH	13.60	1%
No 8 St OH	11.94	0%
3/128 Cu OH	10.59	0%
19/17 Cu OH	8.84	0%
Mink OH	8.03	0%
Swan OH	5.32	0%
Rabbit OH	3.88	0%
Squirrel OH	3.42	0%
Swallow OH	3.25	0%
7/14 St OH	2.62	0%
19/18 Cu OH	2.56	0%
3/12 Cu OH	2.41	0%
7/12 Cu OH	0.74	0%
16mm Cu OH	0.39	0%
Kutu OH	0.29	0%
Cockroach OH	0.18	0%
25mm Cu OH	0.10	0%

Cable types used are medium sized conductors. Paper insulated cables are preferred for most circuits with XLPE conductor being only used on short runs such as tails from fuse-switches to transformers. For new work the larger 185 and 300 sq mm Aluminum conductors are generally used.

Conductor Type	Length km	% Population
HV 3c-95mm Al PILC UG	27822.522	21%

HV 3c-70mm Cu PILC UG	18149.774	14%
HV 3c-16mm Cu PILC UG	16254.602	12%
HV 3c-95mm Al PILC HDPE UG	14345.643	11%
HV 3c-300mm Al XLPE UG	8153.994	6%
HV 3c-300mm Al PILC HDPE UG	8053.523	6%
HV 3c-95mm Al XLPE UG	7862.473	6%
HV 3c-185mm Al PILC UG	6879.097	5%
HV 3c-16mm Cu PILC HDPE UG	5516.121	4%
HV 3c-16mm Cu XLPE UG	3316.155	2%
HV 3c-185mm Al XLPE UG	3226.839	2%
HV 3c-0.0225 Cu PILC UG	3031.835	2%
HV 3c-185mm Al PILC HDPE UG	2806.439	2%
HV 1c-25mm Al XLPE UG	2228.448	2%
HV 3c-185mm Cu PILC UG	2189.817	2%
HV 3c-25mm Al XLPE UG	1143.606	1%
HV 3c-16mm Al PILC HDPE UG	758.613	1%
HV 1c-25mm Cu XLPE UG	677.933	1%
HV 3c-150mm Cu PILC UG	672.284	1%
HV 3c-25mm Cu XLPE UG	205.977	0%
HV 1c-300mm Cu XLPE UG	198.758	0%
HV 3c-120mm Cu PILC UG	179.524	0%
HV 1c-95mm Al XLPE UG	93.929	0%
HV 3c-25mm Cu PILC UG	75.549	0%
HV 3c-95mm Cu PILC HDPE UG	70.821	0%
HV 3c-35mm Cu PILC UG	67.511	0%
Bus	45.841	0%
HV 1c-185mm Al XLPE UG	32.064	0%
HV 1c-16mm Cu XLPE UG	11.358	0%
HV 1c-95mm Al PILC UG	7.85	0%

#### **2.2.4.4 Per substation basis**

On a per substation basis the split of distribution network is presented in the following sections. Customer density is obviously a strong driver of viability and significantly influences ENL's allocation of time, effort and funds.

#### **Gisborne**

Substation	11kV length	Total ICP's	ICP density per
------------	-------------	-------------	-----------------

	(km)		km
Te Araroa	123	488	4
Ruatoria	169	796	5
Tokomaru Bay	166	587	4
Tolaga Bay	172	660	4
Kaiti	121	3013	25
Carnarvon	41	3829	93
Parkinson	31	1843	59
Makaraka	172	3811	22
Patutahi	207	1188	6
Pehiri	138	276	2
Ngatapa	105	252	2
Puha	338	1092	3
Matawhero	25	231	9
Port	27	2753	103
JNL	0.10	2	20

### **Wairoa**

Substation	11kV length (km)	Total ICP's	ICP density per km
Tuai	116	366	3
Wairoa	9	1	0
Kiwi	443	3402	8
Tahaenui	50	277	5
Blacks Pad	82	872	11

#### **2.2.4.5 Terrain**

As the terrain in the region is generally characterised by hilly terrain with relatively narrow weaving river valleys many rural lines tend to be constructed on steep hillsides away from the road edge. Feeders typically begin in rural townships or urban centres and supply both urban and rural customers. The lines pass over the open flats on main transport routes from the townships and quickly transition into the rugged hilly terrain frequently passing over small pockets of rural land with good access. The split of 11kV and LV line length over the various areas is indicated in the following table...

Location	Gisborne (m)	Wairoa (m)	Total (m)
Urban Only	179254	22977	202231
Rural Only	1373412	364261	1737674
Remote Only	300522	82489	383011
Urban Rugged	4913	0	4913
Rural and rugged	432443	259823	692266
Remote and Rugged	111764	157849	269613

Remote lines are defined as being more than 75 km direct line from the main works depot and rugged lines are lines with a span length greater than 130 meters.

### 2.2.5 Distribution Substations





Just as zone substation transformers form the interface between the 50kV and 11kV networks, distribution transformers form the interface between ENL's 11kV and LV networks. These distribution substations range from 1-phase 15kVA pole-mounted transformers with only to 3-phase 1,500kVA ground-mounted transformers dedicated to single customers.

Distribution substations fit into 1 of the following typical arrangements or classes...

- Single pole mounted transformer installations up to 100kVA. A few older 'pole with half pole' sites still exist in the Wairoa district. These installations are protected with minimal fuse protection. There are no 2-pole substations over 100kVA on the network.
- Green metal enclosed pad mount installations 30kVA+. These installations are typically located on private property for single customer installations, ENL land adjacent to road reserves and on grass berm's in road reserve. Installations of this type may have in some cases a secondary enclosure consisting of a mesh fence, concrete block wall or wooden fence. In overhead areas minimal overhead fusing is used while in underground areas 11kV fuse switches provide the protection.
- 5 to 30 KVA pole style transformers with secondary plastic or metal covers. Only a few installations of this type exist.
- There are approximately 10 ENL owned Kiosk type building installations housing larger ground mount transformers. A small number of the customer only substations are also located within concrete block building arrangements similar to the kiosks.



Rating	Number			
	Gisborne		Wairoa	
	Ground	Pole	Ground	Pole
1 kVA		44		11
5 kVA		64		6
10 kVA	1	530	2	168
15 kVA	1	867	1	223
20 kVA		4		89
25 kVA	3	156		55
30 kVA	39	421	4	149
50 kVA	17	158	6	66
75 kVA	2	1		2
100 kVA	43	50	16	28
150 kVA		1	1	3
200 kVA	103		35	6
250 kVA	61	1		
300 kVA	132		22	2
400 kVA	1			
500 kVA	45		7	
750 kVA	2			
1000 kVA	37		7	
1500 kVA	3			

For management purposes ENL also classifies its nine 11kV voltage regulators as distribution transformers. The regulators are ground mounted and have wire mesh fence enclosures.

Location	Purpose
Pehiri	Security
Kopuaroa (between Ruatoria and Tokomaru)	Security
Tatapouri (between Kaiti and Tolaga)	Distance boost
Ngatapa	Security
Matawai	Distance boost
Waingake	Support water works
Muriwai	Distance boost.
Waihua (west of Wairoa)	Distance boost
Mahia	Distance boost

## 2.2.6 Distribution Switchgear



The distribution switchgear associated with the underground distribution network substations is predominantly ABB SD series Oil filled switchgear or ABB Safepus SF6 gas filled switchgear. Switchgear installations are pad mounted and either located adjacent to or a short distance away from the substation installations.

For the overhead network pole mounted 3 phase Air Break Switches are widely used. In more remote locations single phase links or fuses are used to isolate spur lines.

There are a number of pole mounted Circuit Breakers and SF6 Switches also in use on the network

- Hawker Sydley PMR
- Hawker Sydley GVR
- Cooper Systems KFE
- Jin Kwang SF6 SW

Age profiles and further related information is provided in section 2.3.

**2.2.7 LV network**

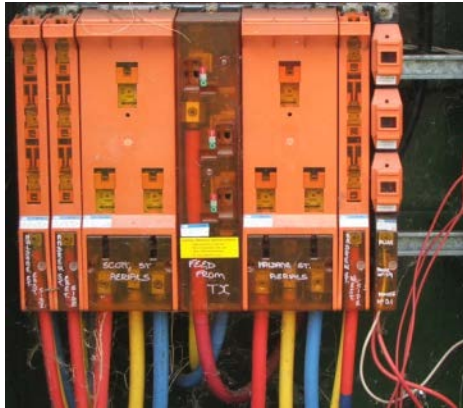

**2.2.7.1 Coverage**

ENL's LV networks are predominantly clustered around each distribution transformer. The coverage of each individual LV network tends to be limited by volt-drop to about a 200m radius from each transformer hence LV coverage is not as extensive as 11kV.

Class	Length Gisborne m	Length Wairoa m	Length Total m
OH LV 400V	395016	136417	531433
UG LV 400V	199728	47755	247483.642
OH SL 400V	12379	161	12541
UG SL 400V	7015	315	7331

**2.2.7.2 Configuration**

The LV networks are almost solely radial with minimal meshing even in urban areas.

**2.2.7.3 Construction**

Construction of LV network varies considerably and can include overhead LV only, LV under-built on 11kV, LV under-built on 50kV, PILC cables, XLPE cables or conjoint PILC – XLPE cables.

The conductor types used are shown in the tables below

Conductor Type O/Head	Length km	% Population
7/14 Cu OH	262647	48.64%
7/16 Cu OH	88313	16.35%

7/16 St OH	46873	8.68%
Ferret OH	21790	4.04%
19/14 Cu OH	18772	3.48%
Rango OH	17541	3.25%
Gopher OH	11870	2.20%
LV 1c-4mm Cu N/S OH	11042	2.04%
19/17 Cu OH	8917	1.65%
Weke OH	7423	1.37%
Dog OH	6586	1.22%
3/12 St OH	5743	1.06%
16mm Cu OH	5343	0.99%
No 8 Cu OH	4727	0.88%
LV 95mm Al PVC Covered OH OH	3978	0.74%
19/16 Cu OH	3820	0.71%
70mm Cu OH	2637	0.49%
Wasp OH	1632	0.30%
LV 2c-6mm Cu N/S OH	1280	0.24%
LV 7c-2.5mm Cu SWA OH	1258	0.23%
7/18 Cu OH	839	0.16%
25mm Cu OH	664	0.12%
19/18 Cu OH	645	0.12%
Swan OH	563	0.10%
Kutu OH	510	0.09%
25mm Al OH	481	0.09%
Mink OH	477	0.09%
LV 3c-16mm Cu N/S OH	379	0.07%
3/12 Cu OH	357	0.07%
LV 35mm Al ABC Covered OH	313	0.06%
No 8 St OH	307	0.06%
No 10 Cu OH	304	0.06%
7/.118 Cu OH	298	0.06%
7/.093 Cu OH	295	0.05%
7/14 St OH	280	0.05%
3/128 Cu OH	268	0.05%
Poko OH	233	0.04%
Magpie OH	175	0.03%
Raccoon OH	111	0.02%
7/12 Cu OH	84	0.02%
Squirrel OH	83	0.02%

LV 2c-4mm Cu N/S OH	80	0.01%
LV 3c-25mm Cu N/S OH	39	0.01%
Rabbit OH	19	0.00%
LV 2c-16mm Cu N/S OH	14	0.00%

Conductor Type Underground	Length km	% Population
LV 1c-106mm Al (Beetle) UG	156471.523	60%
LV 1c-150mm Al (Weta) UG	20071.419	8%
LV 1c-185mm Al (Huhu) UG	16181.891	6%
LV 4c-95mm Al XLPE PVC UG	14355.941	6%
LV 3c-16mm Cu N/S UG	6380.761	2%
LV 3c-35mm Cu N/S + P UG	5376.001	2%
LV 1c-16mm Cu N/S UG	5191.688	2%
LV 2c-4mm Cu N/S UG	4302.381	2%
LV 1c-70mm CU XLPE PVC UG	3027.824	1%
LV 4c-150mm Al XLPE PVC UG	2932.311	1%
LV 4c-70mm Cu PILC UG	2523.182	1%
LV 3c-95mm Al N/S UG	2233.698	1%
LV 1c-50mm Al (Kutu) UG	2200.784	1%
LV 1c-25mm Cu XLPE PVC UG	1994.961	1%
LV 1c-35mm Cu XLPE PVC UG	1711.258	1%
LV 3c-25mm Cu N/S UG	1463.456	1%
LV 1c-185mm Al XLPE PVC UG	1260.898	0%
LV 1c-4mm Cu N/S UG	1234.138	0%
LV 3c-35mm + P N/S UG	1224.826	0%
LV 2c-16mm Cu + P N/S UG	915.892	0%
LV 4c-185mm Al XLPE PVC UG	872.915	0%
LV 3c-70mm + P N/S UG	764.644	0%
LV 3c-70mm Cu + P N/S UG	702.042	0%
LV 1c-95mm Cu XLPE PVC UG	654.576	0%
LV 2c-6mm Cu N/S UG	609.838	0%
LV 1c-25mm+ P N/S UG	547.507	0%
LV 1c-6mm Cu N/S UG	528.999	0%
LV 2c-16mm Cu N/S UG	527.473	0%
LV 3c-120mm Cu N/S UG	400.47	0%
LV 3x1c-19/.052 + 1c-7/.036 UG	371.102	0%
LV 3c-35mm Cu N/S UG	363.069	0%
LV 3c-35mm Cu + P N/S UG	340.987	0%
LV 1c-25mm Al XLPE PVC UG	334.061	0%

LV 3x19/105 Al PVC UG	299.214	0%
LV 4c-35mm PILC UG	259.964	0%
LV 4c-300mm Al XLPE PVC UG	238.582	0%
LV 4c-70mm Cu + P PILC UG	229.015	0%
LV 1c-120mm Cu Cantol UG	210.907	0%
HV 3c-95mm Al PILC UG	162.093	0%
LV 4c-95mm Al PVC UG	87.763	0%
Unknown	79.698	0%
LV 3c-35mm +P N/S UG	70.375	0%
LV 1c-300mm Al XLPE PVC UG	48.168	0%
HV 3c-95mm Al PILC HDPE UG	44.248	0%
LV 1c-185mm Cu XLPE PVC UG	41.678	0%
LV 1c-70mm Cu PVC UG	37.163	0%
LV 4c-70mm Al XLPE PVC UG	36.16	0%
LV 4c-185mm Cu PILC UG	32.506	0%
LV 3c-16mm Cu N/S OH	26.921	0%
LV 2c-7/0.064 + 1c-7/0.036 N/S UG	10.792	0%
LV 2c-10mm Cu N/S UG	5.83	0%
LV 4c-25mm Cu PILC UG	4.112	0%
LV 1c-16mm Cu N/S OH	1.308	0%

Approximate populations of various construction types are presented below...

Description	% Population by Length	
	Overhead	Underground
LV Only	15%	61%
LV Only Remote	3%	0%
LV Only Roadside	27%	8%
LV Only Roadside Remote	2%	5%
LV Only Rugged	1%	0%
LV Only Rugged Remote	0%	0%
LV Under built	19%	19%
LV Under built Remote	4%	0%
LV Under built Roadside	23%	6%
LV Under built Roadside Remote	4%	0%
LV Under built Rugged	1%	0%
LV Under built Rugged Remote	1%	0%

### 2.2.7.4 Per substation basis

On a per substation basis the split of LV network is laid out in the following sections. Similar to the distribution network, customer density is a strong driver of viability and influences ENL's allocation of time, effort and funds.

#### Gisborne

Sub.	LV Line length (km)	Customers (ICPs)	Customer density
Te Araroa	19	488	26
Ruatoria	38	796	21
Tokomaru Bay	24	587	24
Tolaga Bay	26	660	25
Kaiti	70	3013	42
Carnarvon	80	3829	48
Parkinson	33	1843	56
Makaraka	109	3811	35
Patutahi	61	1188	19
Pehiri	14	276	20
Ngatapa	12	252	22
Puha	46	1092	24
Matawhero	14	231	17
Port	46	2753	60
JNL	0.00	2	1

#### Wairoa

Sub.	LV Line length (km)	Customers	Customer density
Tuai	10	366	37
Wairoa	0	1	1
Kiwi	129	3402	26
Tahaenui	17	277	16

Blacks Pad	28	872	31
------------	----	-----	----

LV Switchgear for control and protection of the LV underground network is generally housed in Transformer enclosures as an LV Frame, In Link boxes or as part of a Distribution box. For overhead installations the switchgear typically exists in the form of pole mounted fuses at transformer sites. The underground enclosures are installed with the LV reticulation usually at the subdivision development stage.

ENL has the following Distribution boxes and Link Boxes as part of the LV Network...

Type	Number
DB Other	2549
DB Black Plastic	942
DB Central Metering	86
DB Concrete SS Lid	58
DB Fibreglass Box	114
DB Galvanised Box	602
DB Green Shear	744
DB In-Ground Pit	548
DB Meter box-Metal	10
DB Veranda Box	5
Link Box Other	226
Link Box Aluminium	196
Link Box Black Plastic	33
Link Box Built-In	1
Link Box Concrete	1
Link Box Fibreglass	9
Link Box Galvanised Box	9
Link Box Green Shear	32
Link Box Montrose Box	18
Link Box Polycarbonate	7
Link Box Verandah Box	4
<b>TOTAL</b>	<b>6194</b>



**2.2.8 Customer connection assets**



ENL has 25,432 consumer connections - ENL gets its income by providing electricity conveyance services to these connections for the energy retailers. All of the network assets are used to convey energy to these consumer connections, and essentially are a cost that has to be matched by the revenue derived from the consumer connections. The control points at the consumer connections generally involve assets ranging in size from a simple fuse on a pole or in a suburban distribution pillar to dedicated lines and transformer installations supplying single large consumers. Quantities of customer owned private line quantities are summarized as follows...

- 11kV Overhead lines 374km
- 11kV Underground Cables 15.5km
- 400V Overhead Lines 314km
- 400V Underground Cables 27.5km

In most cases the fuse forms the demarcation point between ENL's network and the consumers' assets (the "service main"), and this is usually located at or near the physical boundary of the consumers' property. However in some cases a single consumer is supplied by a length of line or cable (often on public land) configured as a spur off ENL's network which is referred to as a "service line" (noting that successive revisions of the Electricity Supply Regulations in the late 1970's and early 1980's confused the two definitions). In such cases ownership of the service line has been passed to consumers, who are now responsible for funding and maintaining its safety and connectively to ENL's network.

Type of service connection	Gisborne	Wairoa
Domestic	16376	3372

Non Domestic	4285	1482
<b>Total</b>	<b>20660</b>	<b>4854</b>

### **2.2.9 Load control assets**

ENL currently owns and operates the following three load control transmitter facilities for control of ripple relays...

- Valley Road –11kV injection at 315 Hz (not in service).
- Makaraka – 50kV injection at 315Hz.
- Wairoa – 11kV injection at 1,250Hz.

Historically the majority of controllable load in the urban Gisborne area was controlled by a cascade pilot wire network consisting of 10 pilot feeders.

Due to issues related to the pilot systems functional inflexibility, reliability and expense, in 1992 a ripple load control system was installed on the Gisborne network. The pilot and ripple systems were operated in tandem.

As reliability has become more of issue due to age deterioration of the pilot assets, ENL has phased out the existing Gisborne city overhead pilot system in favor of ripple relays installed at customer's premises. This has been achieved through a ripple receiver installation program started in 2002 and completed in 2008. ENL owns the signal receivers installed on the Gisborne network. Additional ripple receiver installation programs in other parts of the Gisborne network are scheduled to continue until 2013.

The Wairoa urban centre uses a pilot wire system with a small quantity ripple relays deployed in the wider area. The customer relays are owned by the incumbent energy retailer. The retailer has decommissioned the load control relays used in Mahia due to signal attenuation issues. The 8 channel pilot wire system in the urban centre is triggered via SCADA from a central point at the A-Park substation which was installed in 2009. The remaining controllable load operated by the ripple transmitter is insufficient to justify replacement of the transmitter hence it is likely that the focus will be on maintaining the pilot wire system in the urban centre only.

The controllable capability of the system is shown in the following table...

Channel		Interruptible load (kW)
1	Te Araroa	300
2	Ruatoria	600
3	Tokomaru Bay	400
4	Tolaga Bay	500
5	Wainui/Whangara	700
6	Tamarau	1,000
7	Kaiti #1	900
8	Kaiti #2	600
9	Town	500
10	West End #1	1,100
11	West End #2	700
12	Te Hapara #1	600
13	Te Hapara #2	500
14	Matawhero/Makaraka	400
15	Whataupoko #1	500
16	Whataupoko #2	600
17	Mangapapa #1	900
18	Mangapapa #2	700
19	Westpark/Matokitoki	300
20	Patutahi/Waipaoa	400
21	Waimata	600
22	Muriwai/Te Arai	600
23	Pehiri	200
24	Ngatapa	200
25	Matawai	300
26	Puha	500
	Wairoa 00	381
	Wairoa 01	216
	Wairoa 02	327
	Wairoa 03	352
	Wairoa 04	308
	Wairoa 05 Night store (not used)	25
	Wairoa 06	311

	Wairoa 07	345
	Wairoa 08	319
	Wairoa 09 (not used)	37
	Wairoa 16 Night store (not used)	48
	Wairoa 17 (not used)	168
	Wairoa 18 (not used)	179
	Wairoa 19 (not used)	197
	Wairoa 30 Flood Pump (not used)	118
	Wairoa 31 Spa Pool (not used)	30
	Wairoa 32 Cold Store (not used)	60

### **2.2.10 Protection & control**



#### **2.2.10.1 Key protection systems**

ENL's network protection includes the following broad classifications of assets...

- CB protection relays which have always included over-current, earth-fault, sensitive earth-fault and auto-reclose functions. More recent equipment also includes voltage, frequency, directional; distance and CB fail functionality in addition to the basic functions.
- Transformer and tap changer temperature sensors.
- Surge sensors
- Explosion vents.
- Oil level sensors.

There is now a mix of electro-mechanical, discrete component and microprocessor based equipment on ENL's network.

### **2.2.10.2 Voltage control equipment**

Controls with dual transformer tap changers are configured in a master-follower arrangement at older substations and balancing load IsinØ control algorithms are used for new installations. A range of electromechanical, solid state, and microprocessor based controls are used.

Controls are an area in which technology advances make such controls a viable option even for the smallest substations.

### **2.2.10.3 DC power supplies**

Batteries, battery chargers, and battery monitors provide the DC supply systems for CB control and protection functions as follows...

- 110V DC supplies are primarily required for 50kV CB operation and in a number of substations are used for 11kV CB operation and protection.
- 24V DC supplies are typically used for SCADA RTU'S emergency lighting, protection and CB control at newer installations.
- The radio communication systems are typically supplied via 12DC systems.

### **2.2.11 SCADA & Communications**



The SCADA system is used for real-time monitoring and control of the network. Frequency Voltage Current and temperature information is obtained from remote sites, and stored at 30 minute intervals. This

information is used to report load trends for planning and alert operations staff of abnormal conditions.

Real-time status information is collected to alert operations staff of faults and potential issues with the network. Controls are available to turn sections of the network on or off, to minimise outage times, eliminating delays associated with manual switching.

Point of supply load control functions are also carried out using the SCADA.

### **2.2.11.1 Master station**

ENL's SCADA master station is located at the head office in Carnarvon St and comprises an Abbey Systems dual master / backup master station configuration which was installed in 1999. Regular upgrades have been made to the master station and software updates to improve functionality include.

- DNP and Modbus support for intelligent devices in 2001
- SMS Text Messaging upgrade to replace paging system for remote alarming in 2002
- Remote access upgrade 2003.
- SQL database linking for historical trend storage in 2005.
- Aspex Gui interface upgrade incorporating improved windows look and feel, improved graphics and improved real-time/historical graphing and trending in 2006.
- Support for communications via TCPIP networks in 2007.
- Support for historical data storage at remotes with occasional forwarding to the Master Station in 2007.

There are 9 communication ports in use from the Master Station:

- Port 1 - Cable circuit (Gisborne city, 5 sites).
- Port 2 - UHF Radio repeater (Gisborne city, 4 sites).
- Port 3 - Makaretu circuit (Puha / Matawai area, 31 sites).
- Port 4 - Coast radio circuit (Tolaga – Tokomaru, 12 sites).
- Port 5 - Kinikini/Mahia radio circuit (18 sites).
- Port 6 - Cable and Fiber circuit (Gisborne city, 5 sites).
- Port 7 - Wairoa radio circuit (Gisborne city, 28 sites).

- Port 8 - Coast radio circuit (East cape from Tokomaru Bay , 24 sites).
- Port 9 - Access via the Voice RT Network (call in configuration)

### **2.2.11.2 Remote stations**

There are 18 Abbey Systems Full RTU installations located at each of ENL's major substations and 119 Abbey Systems Topcat installations at remote control switches or monitoring and control sites. The Topcat installations were established between 1999 and 2008 as part of the rural automation program which was completed in 2008. The rural automation program covered in previous AMP's was developed and successfully implemented giving the following results...

- enhanced data for improved planning and operational decisions
- Reduced outage times
- Optimised restoration times
- Reduced costs associated with manual switching operations in the field.

In addition to the network sites the SCADA system has an additional 6 sites based on Fanuc PLC RTU's located in the Gisborne Port area used for remote monitoring and control of equipment linked to other Eastland Group businesses.

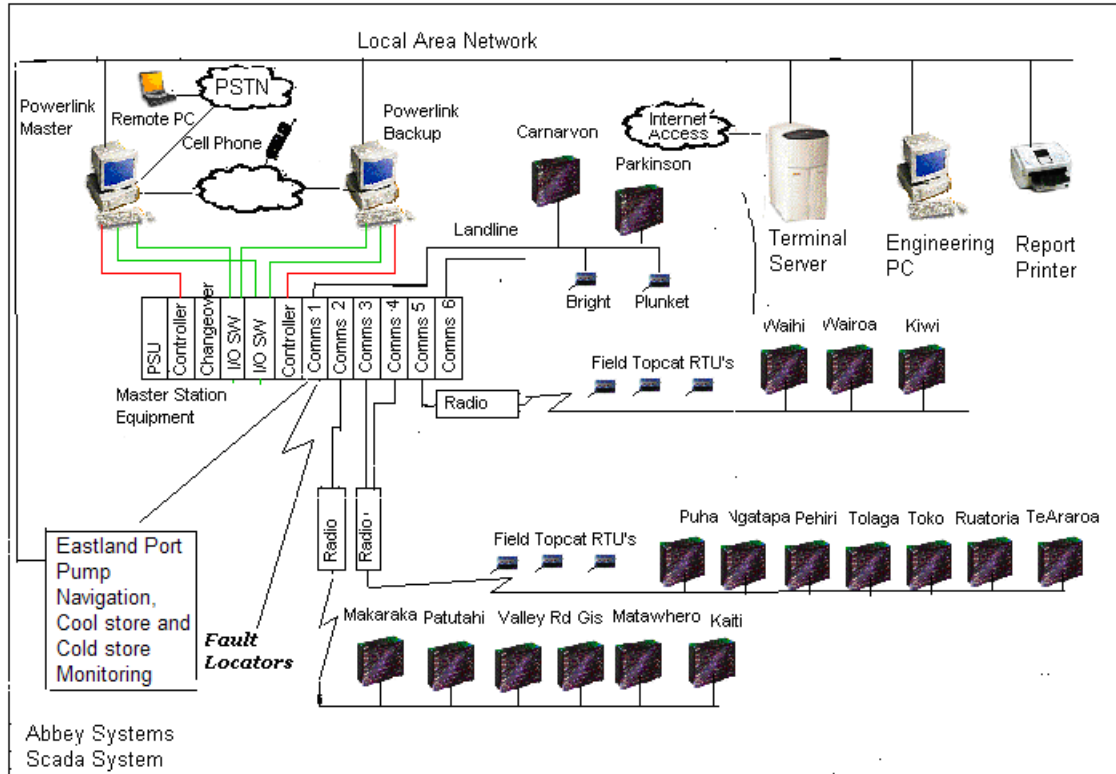

Current issues associated with the SCADA system are...

- Limited redundancy in equipment.

### **2.2.11.3 Communications links**

ENL currently owns and operates the following communications links...

- Four 4RF Digital Links are installed, forming the main back bone.
  - from Matawhero Sub Fiber termination to Makaretu -2002
  - from Carnarvon Street to Whakapunaki -2003
  - from Makaretu to Arakihi -2009
  - from Arakihi to Mata Rd -2010
- Four 1+1 links forming the remaining back bone of the system between Mata Rd and Te Araroa which were installed in 1993.
- Two UHF 1+1 links for contingency support to Makaretu and Whakapunaki.
- A 4 channel 4RF Digital Link is installed between Whakapunaki and Arakihi to facilitate contingent rerouting. -2003



- Seven VHF and two UHF point to multipoint repeaters are also used for SCADA communications to substations and field recloser sites. This equipment was installed between 1999 and 2001 and consists of a mix of new and reused equipment.
- A short UHF point to multipoint link established in 2002 to provide SCADA coverage to the Waihi Power station and a remote switch site.
- Fiber optic Communications cables were installed in 2005 between Carnarvon Street and Kaiti, Port, Parkinson, Makaraka, JNL, Matawhero substations. The cables provide SCADA, Telephone, Protection and IP services.
- A network of WiFi 2.4GHZ radios was deployed in 2005 to integrate EASTLAND GROUP business to the ENL Scada system to provide monitoring of PLC controllers for access security, sewer-pumps, Navigation systems, Cranes and compressor cooling systems.

The existing voice communications system consists of Nine VHF E-band 25W repeaters. Five of the repeaters are all coupled together via the second channel of the 1+1 UHF links between Gisborne and Te Araroa. One repeater operates from Carnarvon St primarily for coverage around ENL's offices. The remaining two repeaters are coupled to the UHF 1+1 system between Gisborne and Kinikini. Both networks are run coupled at the Carnarvon St Control room and have the ability to be decoupled when radio traffic is high. Each repeater can be remotely disconnected from the trunk network in the event of a failure. In 2010 Radio Frequency Services announced a requirement to change all wide band VHF frequencies to narrow band. The changes require replacement of all Voice repeaters and Mobile Radios and must be completed by 2013/14.

A number of communications media and protocols are used to provide voice and data information for operation of the network. Systems include VHF Radio, UHF Radio and Copper or Fiber Cable. Protocols associated with data communication include Modbus, DNP3, Abbey Systems (HTLC).

The following SubsyT

Communications Overview

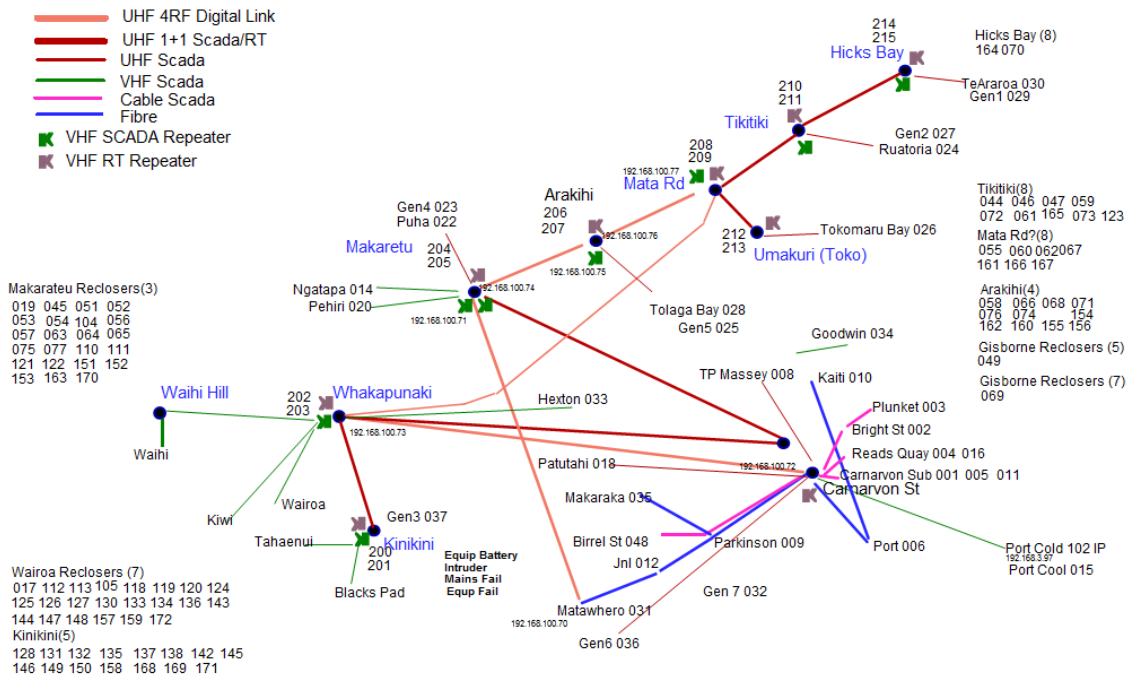

The following locations have back up communications via third party Internet service providers:

- TeArarua Substation (Gisborne.net.nz)
- Ruatoria Substation (Gisborne.net.nz)
- Tolage Bay Substation (Gisborne.net.nz)
- Puha Substation (Gisborne.net.nz)
- Kiwi Substation (Gisborne.net.nz)
- Mahia Generator Site (Vodafone)

The communications network is separate in terms of utilising different equipment but common dependencies exist at transmitter sites which share common power supplies and masts with ENL's communications equipment.

The Network allows connectivity for Camera Monitoring development, Intelligent (SMART Grid) Protection equipment, Assess to information systems and Meter reading.

Current issues associated with the various communications system are...

- Limited redundancy in equipment and communication routes.
- Occasional interference in adverse weather. eg snow build up on antenna.

## **2.2.12 Other assets**

### **2.2.12.1 Generators**

Small diesel Standby generators are installed at critical locations to ensure ENL's SCADA and Communications network can be sustained in contingent events. A 12kVA unit is installed at Carnarvon Street Substation and 5 x 5kVA units are located at Makaretu, Arakihi, Mata Rd, Whakapunaki, and Tikitiki radio repeater Sites respectively.

### **2.2.12.2 Software**

ENL commissioned the Powerview GIS mapping System in 2002 which contains the network Line, cable, Distribution Substation, Switchgear and connection location, connectivity inspection and condition information.

Quickmap software is used to integrate Powerview GIS data with aerial photography and Google earth data to aid with planning and design.

ENL maintains network modeling design software including Load flow and protection coordination using the PSS Sincal software package.

Low voltage design is carried out by engineering staff using LV Drop software.

The Visim line design package was initially purchased from Foleys in 1997 and is used to validate Structure and line design. ENL has developed in house software to replace the Visim line design software.

Design drawings and plans are prepared using Bentley Microstation products.

ICP and billing information is managed via the Talgentra Genfrac system. This system was upgraded in 2010-2011.

Financial Reporting and Works management functions are carried out using a combination of Sage Accpac ERP and Microsoft Access database applications.

Fault dispatch functions are carried out using Microsoft exchange to provide the link between Retailers, the Dispatcher and Fault contractors.

PLC Configuration Software is used to Analyse and setup intelligent devices installed on the network

Miscellaneous communication and data storage functions are predominantly carried out using Microsoft products linked to open value software assurance to maintain currency.

## **2.3 Age & condition of assets by category**

ENL approximates asset condition by age for asset categories with large populations and similar performance characteristics. The life cycle activities described in Section 5 of this AMP qualify the relevance of the age/condition approximation and ultimately determine the rate at which each asset category ages. A summary including average age and values for each asset category is provided in section 2.3.15.

### **2.3.1 Bulk supply assets**

The Bulk supply assets described in Section 2.2 of this plan are owned and operated by Transpower in accordance with their asset management policies and procedures. In general the age and condition and performance of these assets is in line with ENL's expectations.

### **2.3.2 Sub-transmission Lines**

The age of sub-transmission poles is as follows...

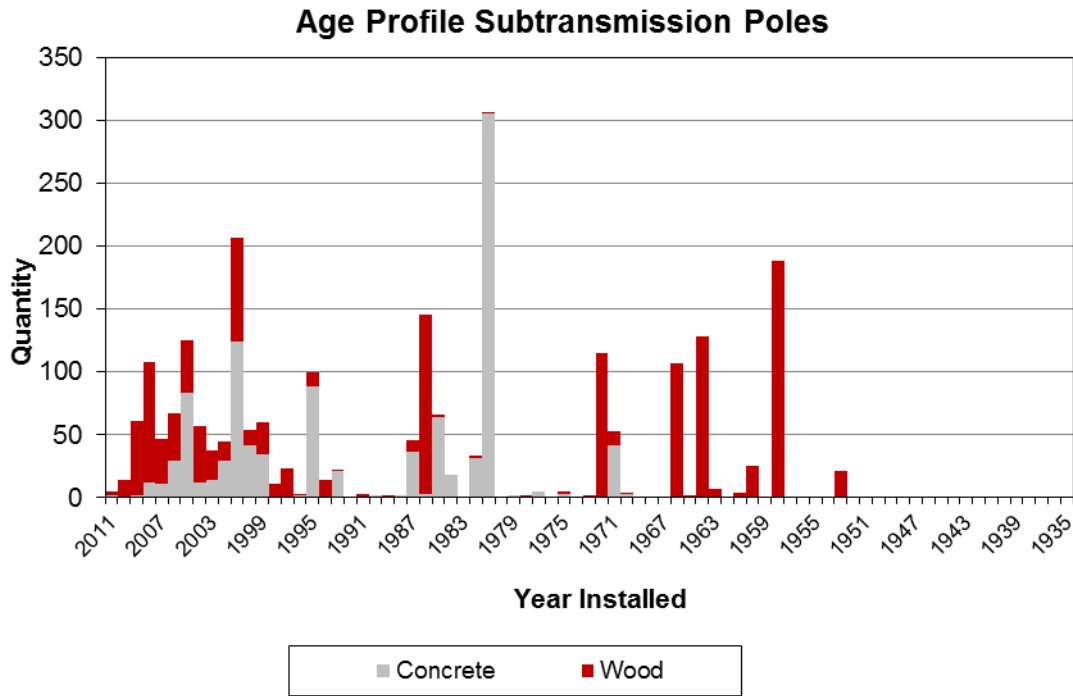

The age of sub-transmission conductor is as follows...

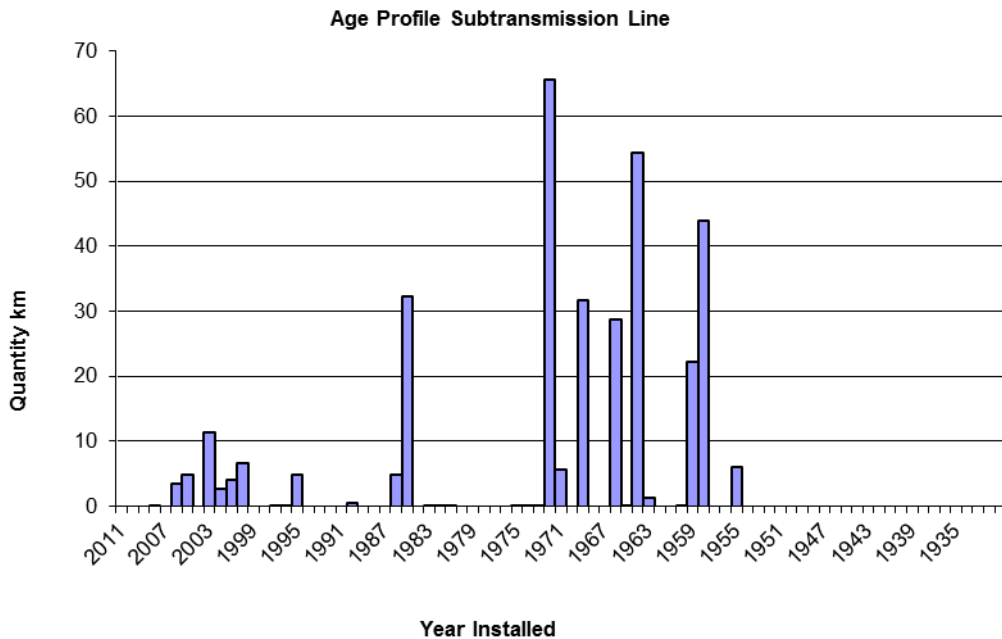

The high growth period between 2003 and 2006 is associated with urban reinforcement.

Conductor is lasting longer than poles in terms of condition however Growth and Security triggers have prompted conductor size increases. Poles are well into their age replacement period while conductor is

predominantly showing the initial installation pattern. Note some conductor is second hand, explaining the less smooth and more spread installation profile.

As the assets are considered critical replacement is planned before the in service failure rate becomes high.

The poles in replacement zone are wooden.

The replacement rate for poles from 1988 indicates the replacement cycle is already in progress.

Despite some conductor being old, there are no identified corrosion or strength issues predicted. Some vibration damage has been identified during inspections. Conductor and bindings are repaired and vibration clamps are fitted as identified. Vibration damage is initially picked up by visual inspection of binders.

Glazing is failing on OB insulations. This is believed to be the result of age, agricultural chemical and sun damage. It results in TV interference complaints, which we are obligated to repair in an acceptable time frame. This is more expensive than coordinating replacement with other planned work. Approximately 5 sites p.a. are identified and corrected.

There is past problem of pole fires caused by failures NGK 10 skirt insulators. These are only rated at 45kV and problem is more prevalent in areas close to the coast. Between 2000 and 2008 the majority of the problem insulators were replaced. No allowance is made for further replacement until problem sites are identified.

There are approximately 750 strings of blue and brown ceramic insulators that are in the order of 80 years old. These insulators were received in 1960, 2<sup>nd</sup> hand from NZED. Industry experience indicates that we cannot expect much more life out of this type of insulator.

The original suspension strings on the Mahia Line were discovered to have severe wearing on the top hook (40% worn through) in 2001. They had also been stressed through incorrect operating voltage (corrected in 2000). A majority of these insulators were replaced between 2001 and 2003. The Mahia line also has no amour rods fitted to protect the conductor which may shorten conductor life. Remaining problems will be addressed as identified.

All other hardware is believed to be in adequate condition to survive the pole.

### 2.3.3 Distribution Lines and Cables

The age of 11kV poles is as follows...

Age Profile 11kV Poles

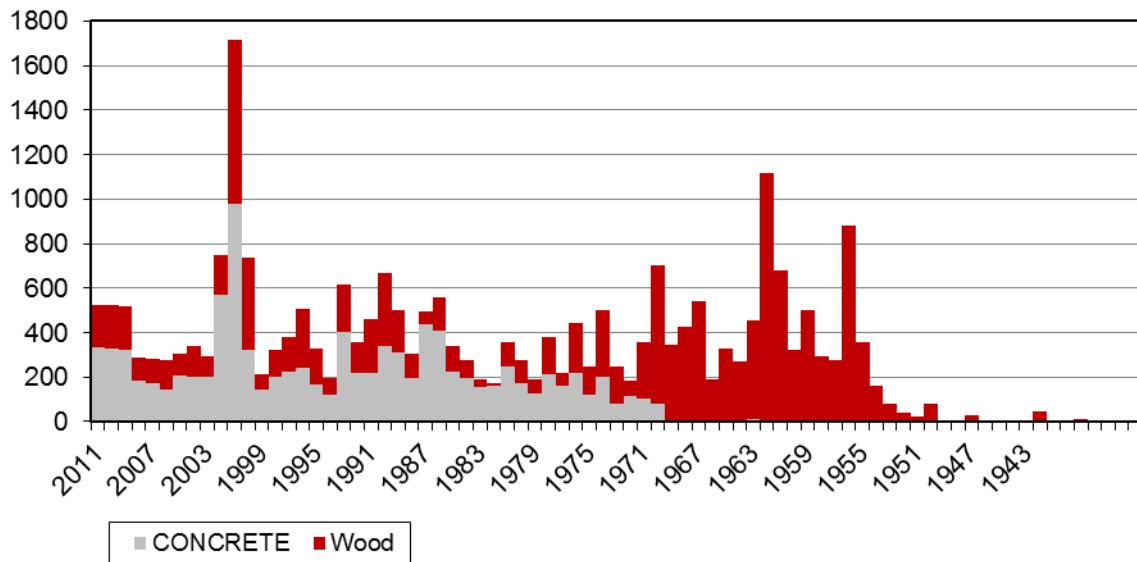

The age of 11kV conductor is as follows...

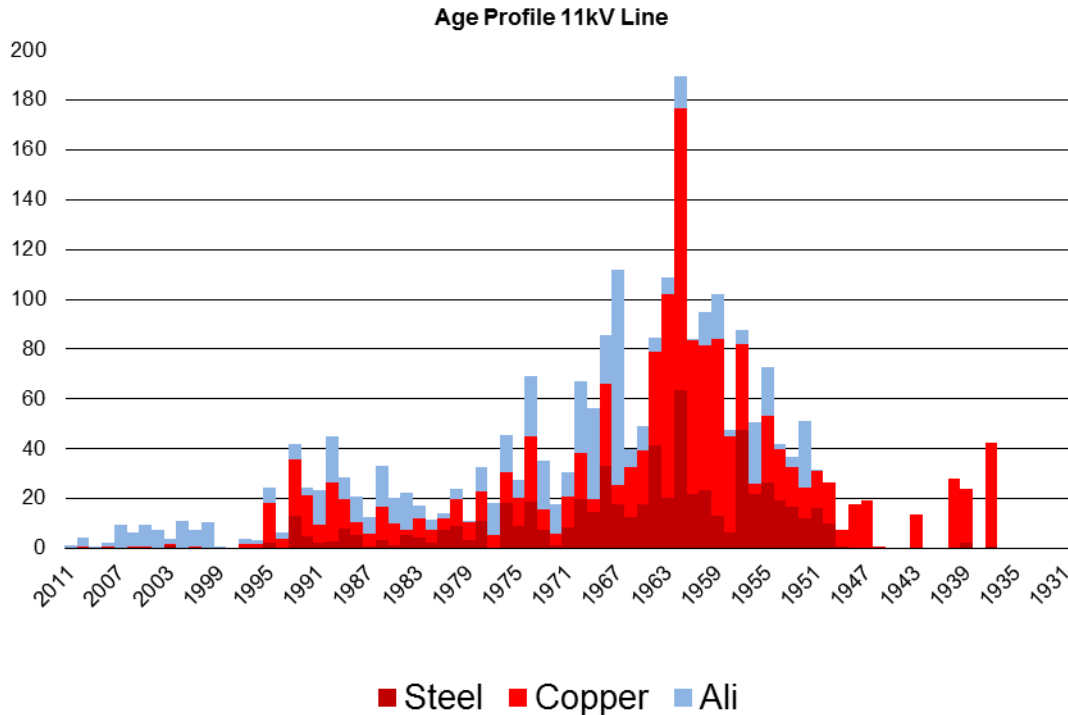

The profiles indicate that poles are well into a replacement program. The nominal 60-year life represents the end of the age failure period, which is more applicable to wooden poles, not the start.

The conductor population is older than the pole population which reflects the expectation that conductor will exceed the 60 year life expectation. Analysis of conductor failures generally indicate underlying causes e.g. Falling Trees, foreign interference and hardware failure, have contributed to the perceived overall conductor condition

The installed 11 kV conductors consist of aluminum (22%), steel (27%) and copper (51%) construction.

Approximately 30% of conductor population and 50% of the pole population is in the failure portion of the life cycle.

78% of the conductor used is copper or steel. The conductor size is typically small due to lack of historical capacity upgrades.

There is 661km of galvanised steel conductor on the network. Approximately 125km is rusting badly to the point where breakages are becoming difficult to repair. Currently repair costs are below the replacement threshold however sections of this conductor will require replacement over the next 10 years.

The age of 11kV cable is as follows...



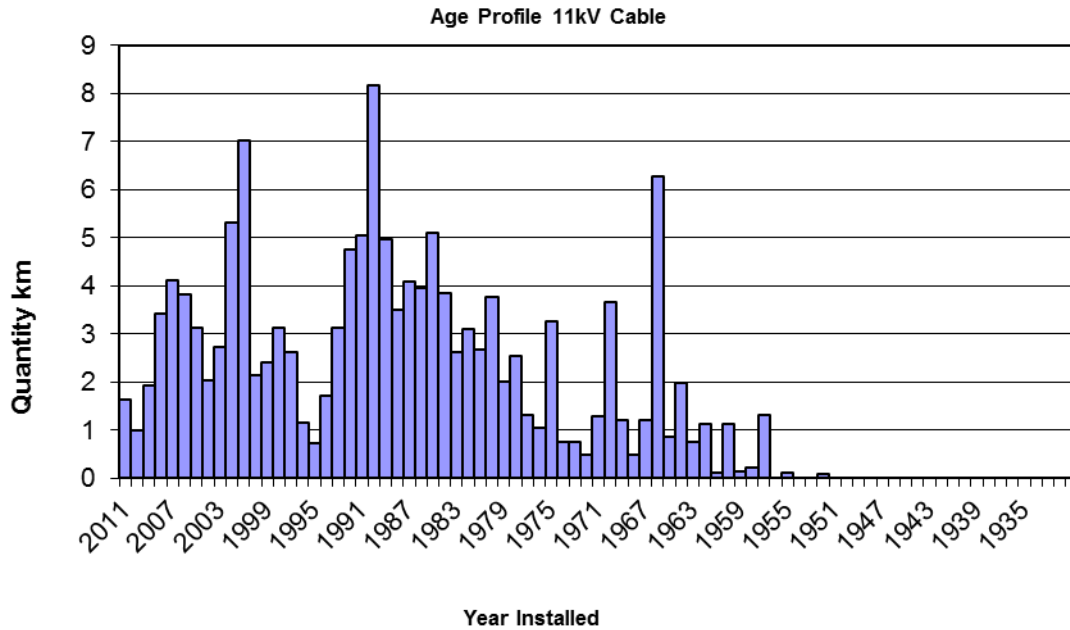

Due to sample size of cables and the relative new age of the asset the profile is showing an installation pattern rather than renewal. In general capacity upgrades are sufficient to mitigate age replacement

### 2.3.4 Zone Substation Transformers

The age of Zone Substation Transformers is tabulated as follows

Zone Substation Transformers				
Location	Type	KVA	Manufacture date	
01 Te Araroa Sub	50/11 - 3 Phase	2500	1/01/1998	
02 Ruatoria Sub	50/11 - 3 Phase	5000	1/01/1997	
03 Tokomaru Bay Sub	50/11 - 3 Phase	2500	8/08/1997	
04 Tolaga Bay Sub	50/11 - 1 Phase O/Hauled 1996	1667	1/01/1965	
04 Tolaga Bay Sub	50/11 - 1 Phase O/Hauled 1996	1667	1/01/1965	
04 Tolaga Bay Sub	50/11 - 1 Phase O/Hauled 1996	1667	1/01/1965	
04 Tolaga Bay Sub	50/11 - 1 Phase Spare Unit	1667	1/01/1965	
05 Kaiti Sub	50/11 - 3 Phase	12500	1/01/1987	
06 Carnarvon Sub	50/11 - 3 Phase	12500	1/01/2003	
06 Carnarvon Sub	50/11 - 3 Phase	12750	1/01/1995	

07 Parkinson Sub	50/11 - 3 Phase	12500	1/01/1986
07 Parkinson Sub	50/11 - 3 Phase O/Hauled 2004	12500	1/01/1971
08 Makaraka Sub	50/11 - 3 Phase	12750	1/01/2001
09 Patutahi Sub	50/11 - 1 Phase	1667	1/01/1948
09 Patutahi Sub	50/11 - 1 Phase	1667	1/01/1948
09 Patutahi Sub	50/11 - 1 Phase	1667	1/01/1948
09 Patutahi Sub	50/11 - 1 Phase Spare Unit	1667	1/01/1948
09 Patutahi Sub	50/11 - 1 Phase	1667	1/01/1941
09 Patutahi Sub	50/11 - 1 Phase	1667	1/01/1941
09 Patutahi Sub	50/11 - 1 Phase	1667	1/01/1941
09 Patutahi Sub	50/11 - 1 Phase Spare Unit	1667	1/01/1941
10 Pehiri Sub	50/11 - 3 Phase	2500	8/07/1996
11 Ngatapa Sub	50/11 - 3 Phase	2500	1/01/2007
12 Puha Sub	50/11 - 1 Phase	1667	1/01/1949
12 Puha Sub	50/11 - 1 Phase	1667	1/01/1949
12 Puha Sub	50/11 - 1 Phase	1667	1/01/1949
14 Matawhero Sub	50/11 - 3 Phase	5000	1/01/2001
14 Matawhero Sub	50/11 - 3 Phase	5000	14/08/2000
15 Port Sub	50/11 - 3 Phase	12750	1/01/2001
16 JNL Sub	50/11 - 3 Phase	12750	1/1/2004
31 TPWairoa Sub	33/11 - 3 Phase	12500	1/01/2007
32 Kiwi Sub	50/11 - 3 Phase	6300	1/01/1983
33 Blacks Pad Sub	33/11 - 3 Phase	1500	14/05/2000
34 Tahaenui Sub	33/11 - 3 Phase	1500	14/05/2000
35 Waihi Sub	50/11 - 3 Phase	6300	1/01/1983
Spare - Mahia	33/11 - 3 Phase Spare Unit	2500	14/5/2000

The general expectation for transformer life is 60 years if the load has generally been low and overhaul work has been undertaken at 30 years alternatively 45 year life is expected if no life extension work has been carried out.

Zone transformers are considered critical equipment as the lead-time for replacement or repair can be months and they are generally too expensive to warrant holding spares. For this reason it is important that they are replaced before there is any risk of in-service failure

Tap changers are the weak link in transformer reliability. ENL carries a spare OLTC unit for its IMP transformers, Regular overhauls and checks are carried out to ensure optimum performance. A range of other spares such as bushings are also carried.

There is a surplus of single phase units currently in service for the single phase transformer banks. Therefore a number of units can be allowed to fail in service before total replacement is required.

Dual transformer installations can also avoid early replacement due to the higher security provision.

Known performance issues and past events that have limited transformer life include the following: -

**Patutahi**

Blue phase transformer on T2 bank has a low test, but it is to be removed from service if it fails.

**Puha**

The alternative to defer T1 replacement is to construct a tie line to Puha, improving the security support to Puha and reducing the area affected in the event of an outage. Currently the generator at Puha is providing the necessary security provision.

**Tolaga**

The T1 transformer bank has had a major overhaul in 1996. A number of the radiators have had repairs in 2010 and 2011.

Renewal forecasts show the planned replacement dates for the transformers above. It is possible that Matawhero substation will require larger transformers allowing the existing units to be moved to Tolaga and Puha.

**2.3.5 Circuit Breakers**

The age of Circuit Breakers is as follows...

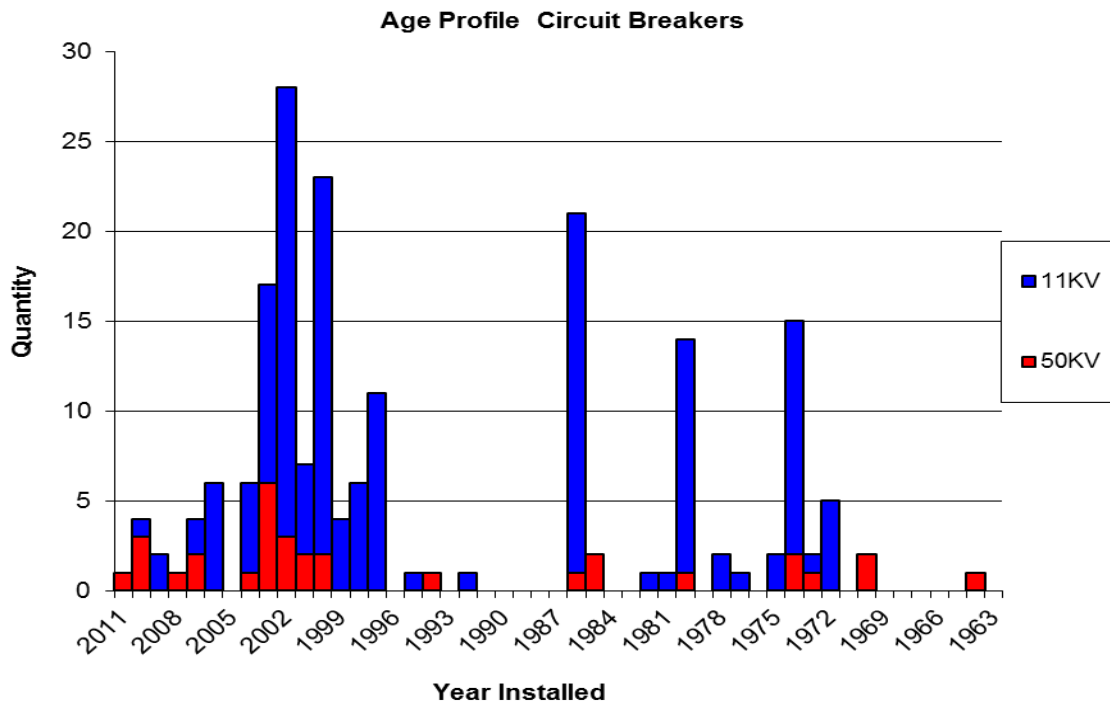

The data includes all 50kV, 11kV, indoor and outdoor equipment located within Zone Substations and installed in the wider Network. There is insufficient population of any single type to draw conclusions. The period from 1999 to 2004 reflects rural CB installation and Zone substation upgrading programs.

All circuit breakers are equipped with SCADA remote control systems. 11kV switchboard reliability is critical and therefore early replacement is desirable.

The 50kV Bulk Oil CB's were obtained 2<sup>nd</sup> hand from Transpower and refurbished. Prior to installation they were 40 to 50 years old and based on current assessment replacement of these units will be necessary within the planning period as the mechanisms become unreliable and the insulation of the equipment begins to fail. The refurbished units are used in locations where the peak load does not exceed 10MW, fault levels are low to ensure maximum life extensions are obtained, and slow clearing times are acceptable.

### 2.3.6 Pole Mounted Isolation Equipment

The age of 11kV fuses is as follows...

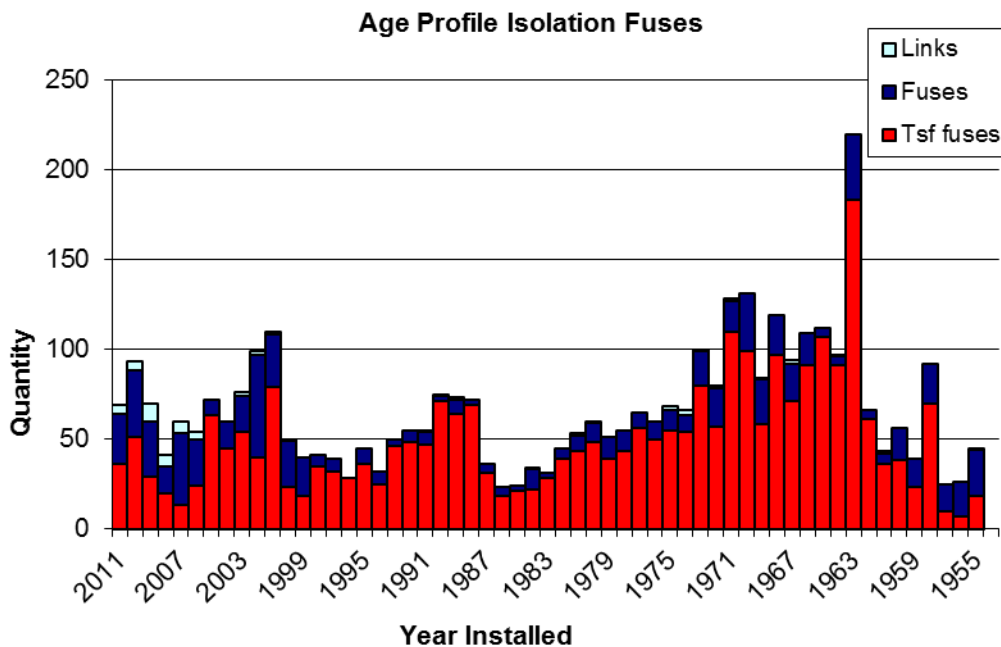

The transformer fuses are indicating a pattern which is into a replacement cycle which generally coincides with transformer replacement.

The age of 11kV pole mounted Switches is as follows...

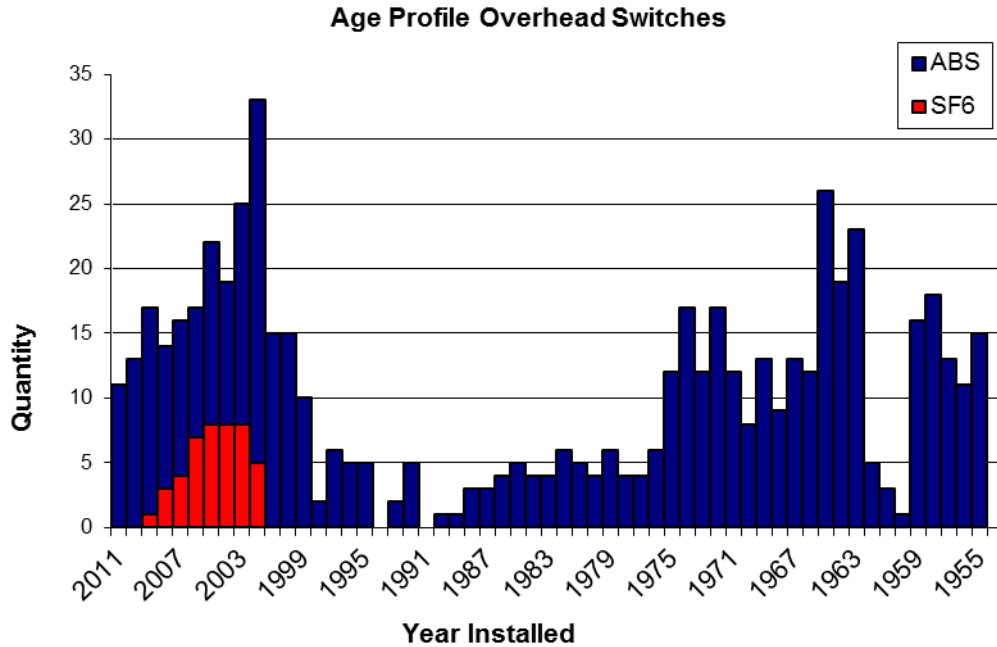

The ABS units initially were installed during construction with minimal attention or operational use. More recently as pole replacement has commenced the use of switches has increased. Any issues with operation are identified and corrected when found.

50kV ABS's are well maintained and are relatively new. Therefore they are expected to deliver a service life equivalent to the ODV life of 35 years.

Quadrant ABS's with a wire operating system have been identified as potentially problematic should the operating wires break during operation and come into contact with live LV. The proportion of 200Amp Quadrant wire operated Air break switches installed on the network is estimated at 50% exact quantities are being established as part of line inspection programs. These switches have a priority for replacement where they are located on poles with LV or at locations where the consequence of failure is high. The characteristics of these ABS's that make them less suitable than the current ABS standard are...

- While it meets the minimum standard the open contact spacing is closer than newer switches. The requirement is a gap of 150mm minimum.
- The switches are not rated to break load (10A maximum). Controllers and operators risk making errors in identifying this limitation as it is not identified on site or on the system diagram. Given the maximum load on most rural feeders and spur lines is well below 10A the switches are adequate for these locations. Switches on higher loaded feeders are systematically being identified and replaced.
- They are wire operated. Should the operating wires break during operation they may come into contact with live LV where it exists on the same structure.

### 2.3.7 Switchgear Ground Mounted

The age of 11kV Ground Mounted switches is as follows...

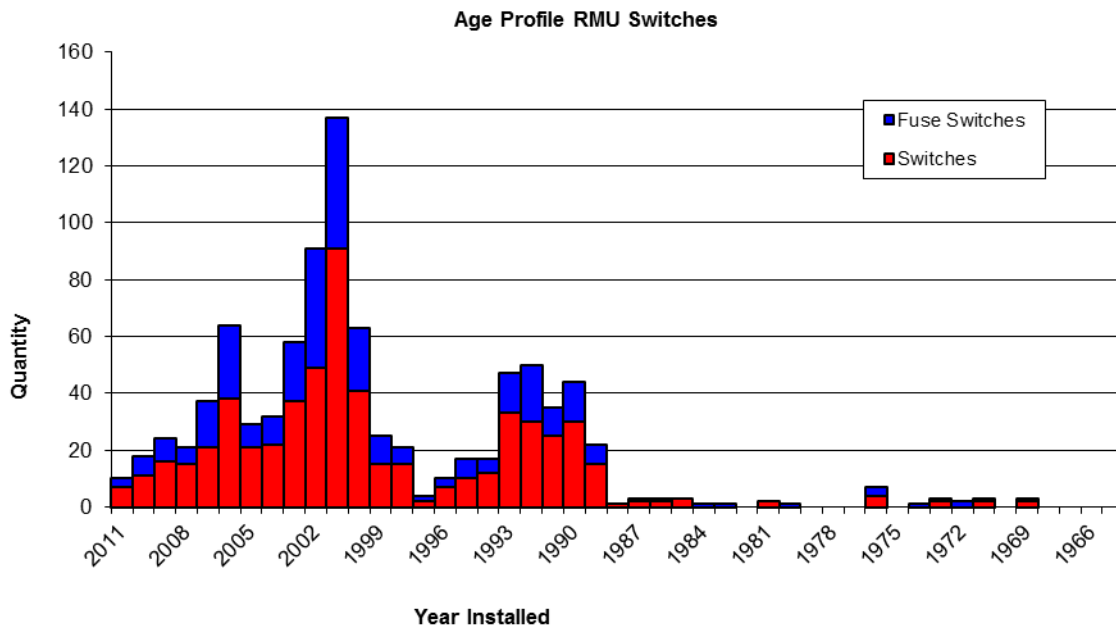

The quantities are based on individual switching units as opposed to complete assets containing multiple switching units.

Most of the equipment in use is either ABB Oil filed SD series or ABB SF6 Safelink Switchgear.

The design deficiencies in older units have largely been eliminated by upgrades.

The population is relatively young largely due to early replacement due to older designs not meeting the necessary safety, performance and reliability requirements. These types include a small remaining quantity of Magnefix, Rotary 'RTE' and series 1 Andelect units.

Installation quantities are generally dependent on other work such as under-ground reticulation or installation of new large transformers.

### 2.3.8 Distribution substations

The age of transformers rated at 100kVA or greater is as follows...

Age Profile Transformers >= 100KVA

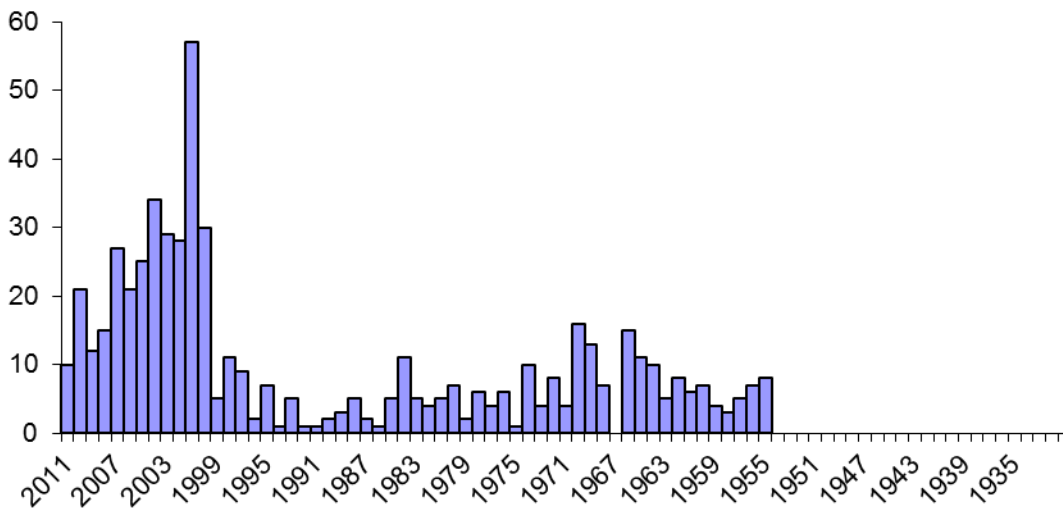

The age of transformers rated at less than 100kVA is as follows...

Age Profile Transformers <100KVA

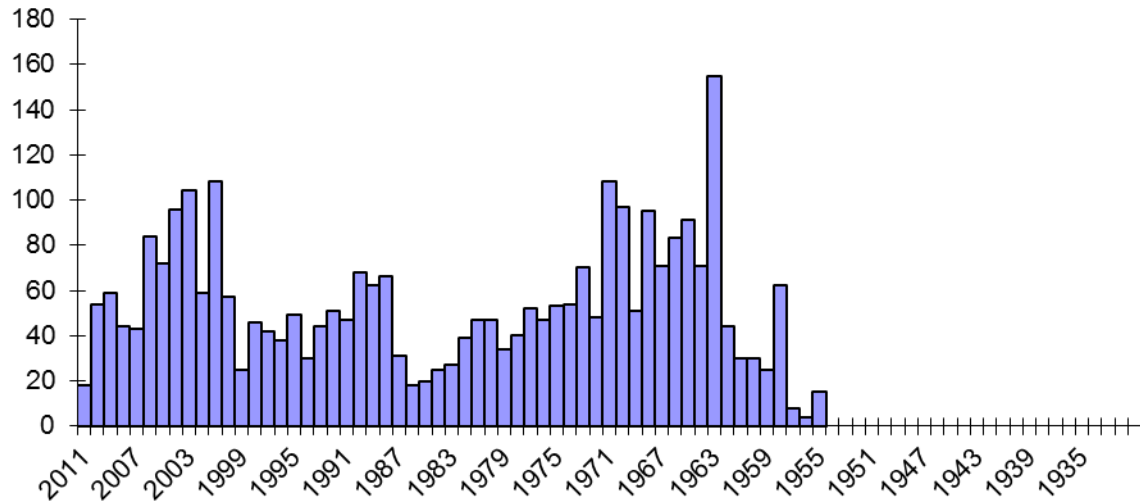

Transformers have a reasonably fast roll-off in survival spanning a 5-10 year period indicating sudden total failure mechanisms (e.g. tank rusting through, lightning strike, structure collapse or fault overload.) The transformers therefore have high reliability and good overall condition. Due to the rapid decline in condition over a period less than the inspection cycle for smaller units below 50kVA the optimum replacement time for these units is post failure. Opportunistic replacement in conjunction with structure replacement is also carried out where appropriate in terms of the Transformer age/condition.

Large transformers ( $\geq 100\text{kVA}$ ) have an even installation profile. On average 12 were installed per year from 1960-1985, and 5/yr after 1985- 2000.

The Compliance program in 2000 eliminated the majority of the older group of pole mounted 250kVA units.

Smaller transformers have been in a replacement cycle since 1988 at an average rate of around 60/yr.

Residual survival is considered negligible as it is only evident in large transformers which reflects the past maintenance attention they have received.

Ground-mount multi-fin transformers have been identified through inspections, to have rust issues around the fins and have the potential to develop leaks. The units have been identified and incorporated into replacement programs.



Failure analysis shows that the predominant cause of in service failure is tank life being reduced by rust. For this reason age is generally a good indicator of condition with units situated in costal locations being a secondary factor.

### 2.3.9 LV network

The age of LV poles is as follows...

Age Profile LV Poles

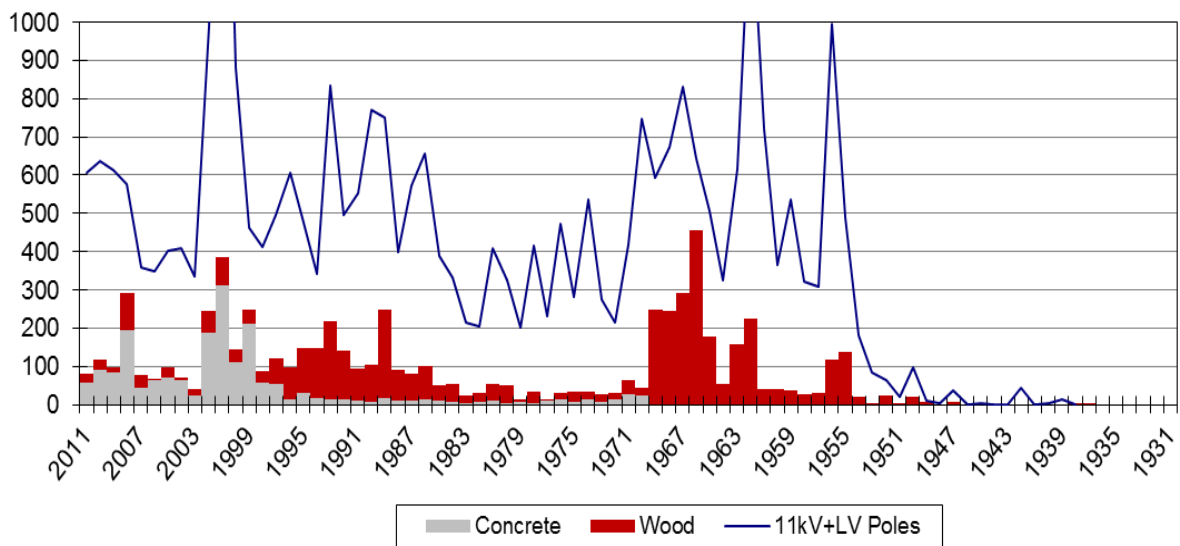

The age of LV conductor is as follows...

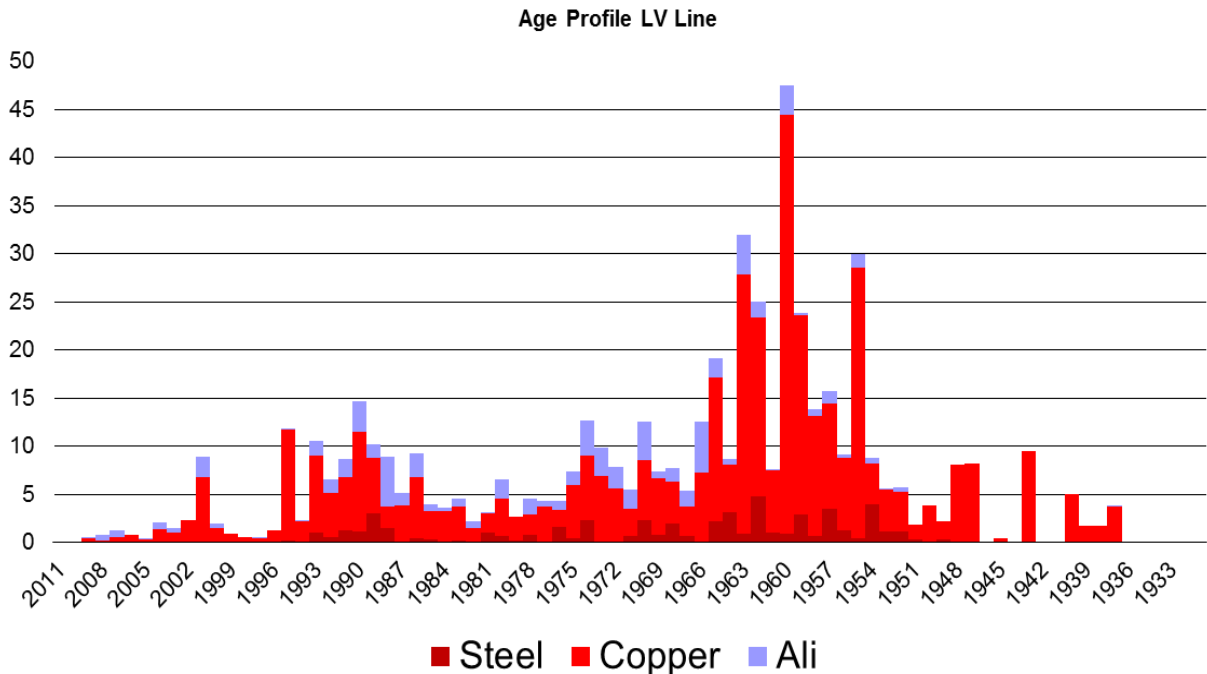

The LV overhead network generally is below design standards in terms of conductor size and length of circuit.

This low standard of LV construction has arisen due to a policy of not upgrading capacity unless age replacement is required. The historical reluctance to avoid capital renewal unless coordinated with under-grounding activity has also contributed. However it is a valid business strategy to trade off capital expenditure for increased technical losses but this becomes sub optimal in the long term. In urban networks where annual load growth in domestic installations is approximately 1%, the 20% security capacity contingency for overhead lines will be consumed in 20 years.

Conductor tends to be replaced far sooner than poles due to capacity upgrades.

Poles tend to be left until in-service failure or need for replacement associated with new connections or conductor upgrade.

The low pole installation in recent years has some correlation with under-grounding and use of 11kV under building.

Average span in urban area very short at 30m allowing more lea-way in deterioration before design criteria is compromised.

The main performance issues are related to age or condition and minimal maintenance practices. These issues include...

- Failing connectors causing conductor burning
- Breaking conductor after clashing or external interference.

- Stretched and sagging conductor vulnerable to wire wraps and being caught by high vehicle loads

LV overhead lines are managed in a reactive mode when fuses overload and voltage complaints are received. LV conductor is fused to full duty rating. Often during faults this rating is exceeded for short periods, particularly on overhead open lines. Where this has occurred regularly there is evidence of conductor life being shortened due to annealing of HD Cu., i.e. loss of tensile strength resulting in breakages.

The age profile of LV cable is as follows...

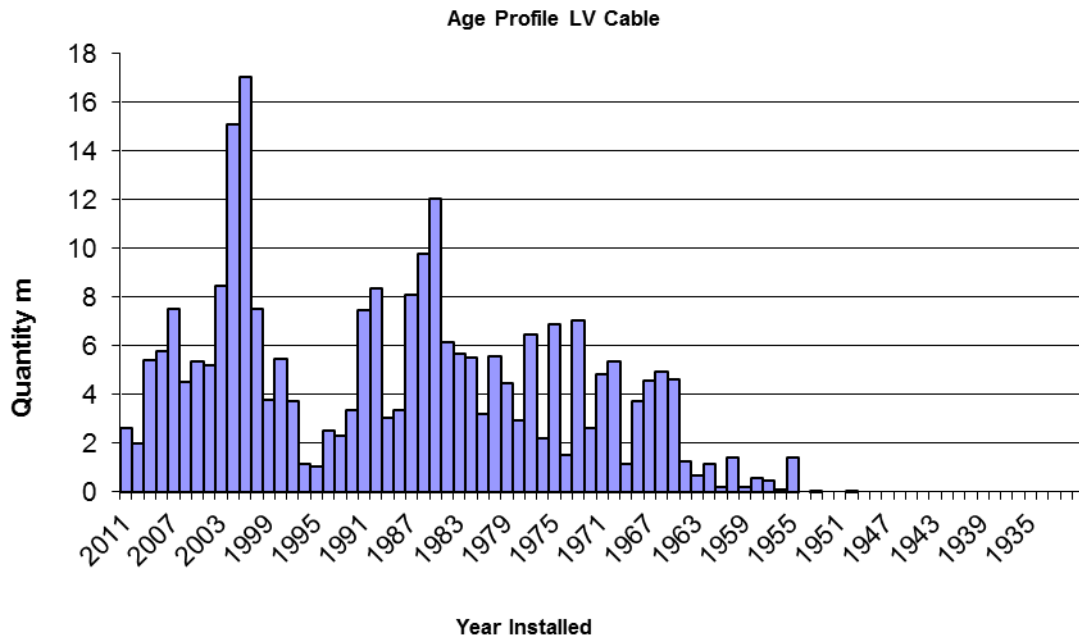

The cable installation rate shows a strong correlation with reduction in overhead line installation.

Minimal replacement levels are evident but the age profile is driven more by capacity upgrade.

Generally transformers overload before cables and this is allowing issues to be overcome through increasing transformer density thus reducing LV run lengths. This approach will be adequate until transformer capacity is not needed for the load density it is more economic to re-conductor.

The average age of LV switches is as follows...

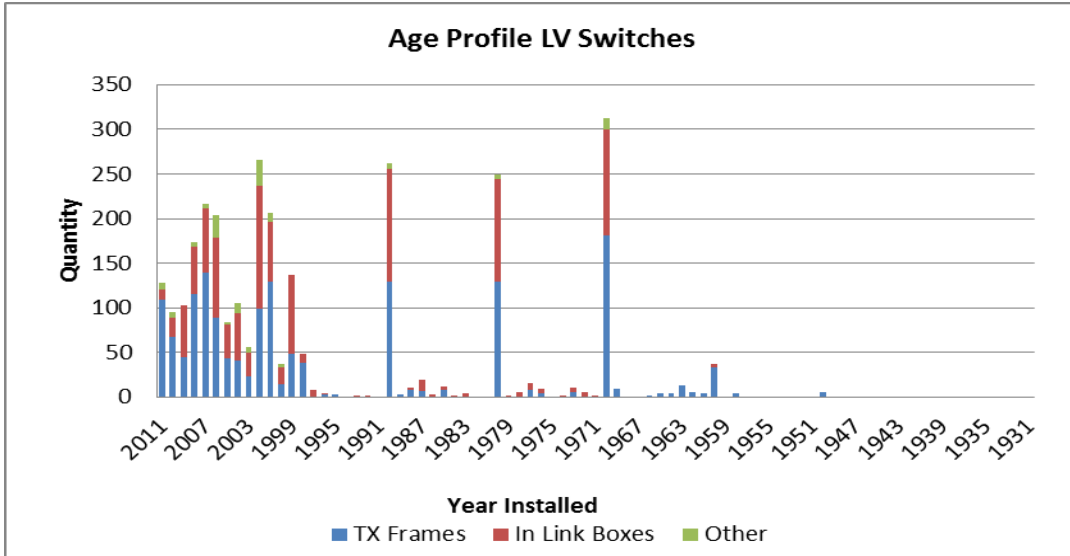

The dataset for LV switchgear including Transformer and Link box frames shows an incomplete pattern and approximate age as past documentation was not considered necessary. This equipment has a relatively young average age because its installation is associated with cables and ground-mount transformers. Therefore it has to be aged to the point where survival can be accurately assessed. Safety standards and performance of early installations is driving replacement. Most of this is undertaken in conjunction with other work such as transformer renewal.

The age of Distribution Boxes is as follows...

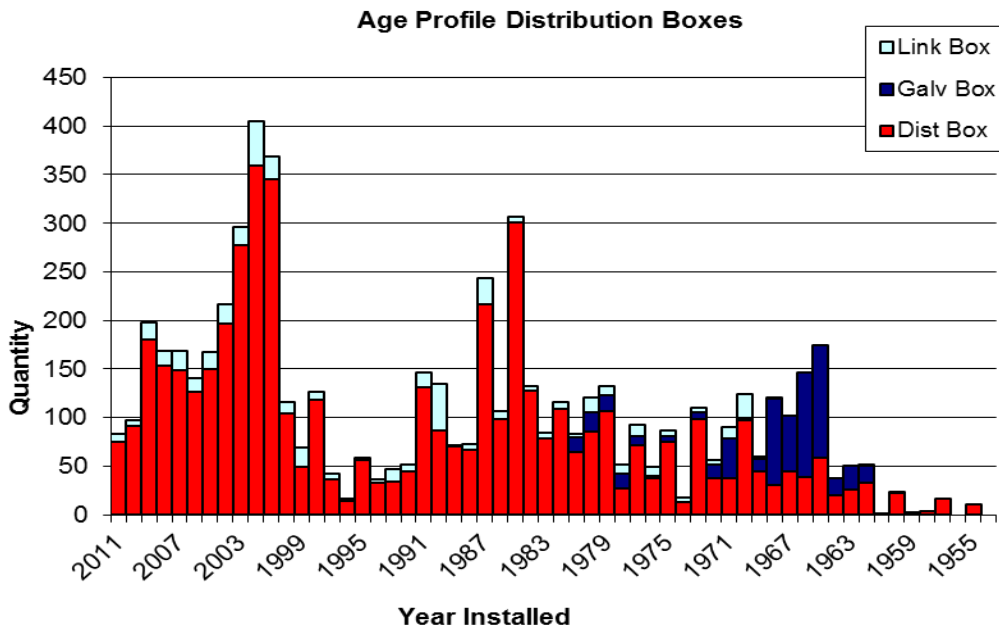

Replacement of the older galvanised boxes is underway as overall deterioration is identified during inspection.

**2.3.10 Consumer connection assets**

The age of consumer connections is as follows...

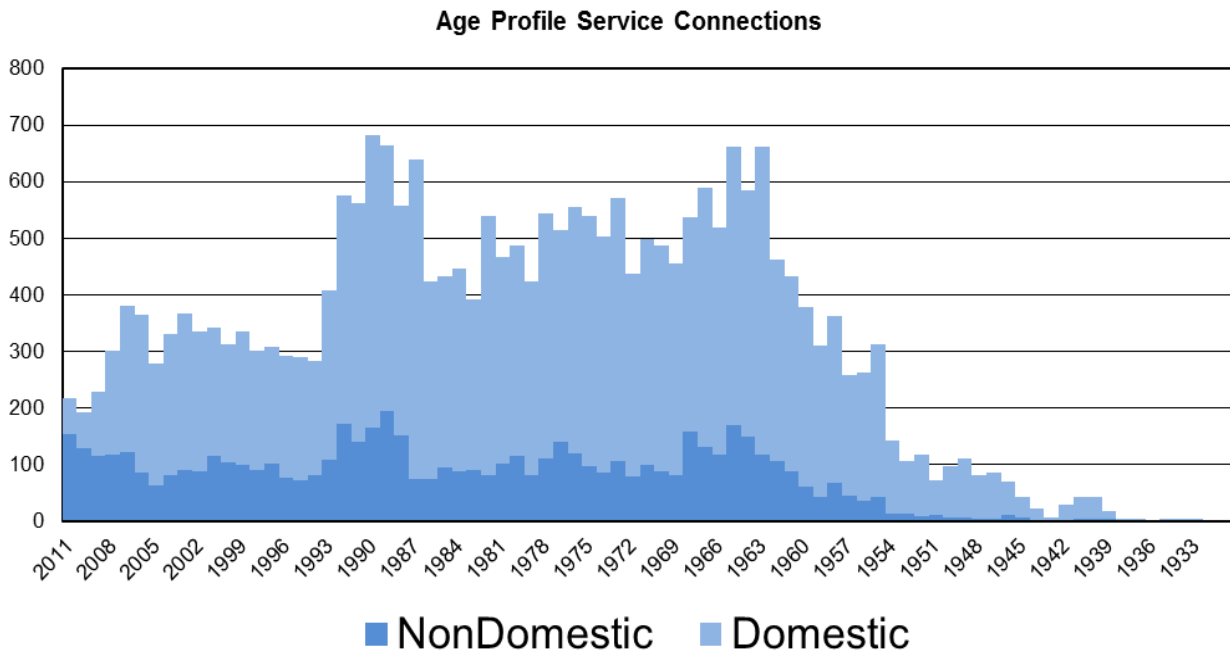

Failure of service fuses and connectors are the main faults. No preventive replacement programs are undertaken due to difficulty in predicting aging as this is dependent on loading conditions.

Approximately 25% of fuse bases require replacement when the fuse needs replacing. This is caused by burning on the terminal of loose jumper connections or corrosion. The problem is related to quality of the product and installation.

Service failures are treated as non-critical because they affect only one connection.

In some urban areas of the network service fuses are housed in metal clad meter boxes located on the front property boundary. These boxes were installed in the 1960's as a substitute to the traditional meter box. Many of these (approx. 300) boxes have become deteriorated with age or have been otherwise damaged and are in an unsafe state. The current ownership of these boxes is not clear cut and as such a scheme is in place where the cost of replacement of the box is shared between ENL, the customer's energy retailer and the property owner.

In addition ENL is segregating its equipment from the replacement meter boxes and relocating into new service fuse boxes.

An age deterioration and damage issue also exists with similar issue with sun damaged fiberglass service fuse boxes. ENL has a program in place to replace these boxes with new service fuse boxes.

Voltage drop in the customers' service main is the main reason for poor performance. ENL has not actively managed this in the past as it generally only affects the service of the consumer responsible for it. The higher losses however do reflect into the costs of the network and are ultimately shared by all customers.

Poor power factor also affects service connection performance driving the need to invest in transmission capacity. Offending installations will be notified to owners and failure to correct issues will result in penalty charges generally by way of increased kVA assessments.

Harmonic generation will be handled via penalty charging where it only affects ENL equipment. If it affects other consumers then disconnection and compensation to those consumers will be enforced.

### **2.3.11 Load control assets**

Approximate numbers of remote load control devices are...

<b>Description</b>	<b>Number</b>
Ripple relays installed in Gisborne between 1990 and 2009.	10,875
Pilot-wire controlled loads in Gisborne.	2,755
TrustPower-owned installations in Wairoa.	Approx. 2,000
<b>Total</b>	

The Wairoa system operates at 1250 Hz, which is subject to high signal attenuation which potentially results in unreliable control. As a result of having high sensitivity receivers installed and issues relating to cost responsibility for Retailer owned receiver upgrading, the effectiveness of the load control system in rural areas has diminished to the point that it is no longer viable to renew the ageing injection plant. Urban control in Wairoa is via a pilot wire system.

The Gisborne frequency injection plant operates at 317HZ and signal attenuation issues at this frequency have proven to be less common.

As the age of the Injection plants increases the frequency of breakdown has increased. It has been indicated that due to the transformer upgrade project at the Gisborne GXP that the Gisborne injection plant is nearing maximum capacity. To overcome the capacity issue will require the installation of a new Injection transmitter facility. Investigation is continuing into the required timing and cost of this installation.

The age profile of ENL's relays averages 13 years due to the recent replacement of the pilot wire contactors with ripple relays in the Gisborne city. Renewal programs for ripple relays are reactive in nature and are triggered by failure of the units to operate.

### **2.3.12 Protection & control**

The protection and control equipment used predominantly at Zone Substation sites is varied in terms of functionality and performance characteristics for this reason condition and performance are assessed on a case by case basis. Due to the small population and variety of systems used age analysis provides an indication of the appropriateness of technologies to provide the desired performance rather than condition.

#### **2.3.12.1 Key protection systems**

Protection equipment was traditionally expected to last the life of the device it protected. However newer electronic equipment is unlikely to perform adequately after 10 to 15 years. This equipment is required to co-ordinate across the network and therefore must maintain compatibility with ENL's and Transpower's latest technology. Generally technology upgrade is required before renewal.

The electro mechanical protection relays used at Carnarvon Street substation have been found to drift from setting values which is typical for equipment of this age. The Earth fault settings are inverse-time and do not coordinate well with downstream protection equipment.

#### **2.3.12.2 Voltage control equipment**

Tap change control relays provided by IMP with earlier transformer purchases have proved unreliable between 2001 and 2007 the units were replaced with RegD control relays and no further issues have been identified.

Older voltage regulators are currently fitted with mercury filled switch mechanisms. Replacement with PLC controls is planned when the existing units show signs of miss-operation due to mechanical wear.

### **2.3.12.3 DC power supplies**

The DC power supplies have been progressively replaced from 1999 as older charges have become noisy and unstable. The equipment has an average age of 3 years.

24 and 12 volt battery banks are generally less than 5 years old as renewal is more economic than regular testing due to the distances to sites. The condition of batteries installed in pole mounted automation installations deteriorates at a greater rate due to summer temperatures generally achieving a maximum 3 year life.

110V Battery banks are replaced at intervals of 6 to 10 years depending on condition testing hence the age of these installations averages around 8 years.

### **2.3.13 SCADA & Comms**

As the Abbey Systems SCADA (Supervisory Control and Data Acquisition) system was purchased in 1999 the average age of the components is approximately 9 years. The communications systems in place at the time of the SCADA system purchase were re-used for the new system with progressive replacement of links and repeaters in progress over a 15 year cycle.

#### **2.3.13.1 Master station**

SCADA systems have an ODV life of 15 years as equipment ages support becomes expensive and replacement technology becomes attractive.

Replacement systems generally cost less, are smarter, less proprietary, etc. Like other computer based systems replacement is frequent and continual.

#### **2.3.13.2 Remote stations**

To maintain functionality and compatibility with master station functionality the age of RTU's follows a similar pattern to the master station equipment influenced only by new rural automation sites.

#### **2.3.13.3 Communications links**

The age of communications equipment is tabulated as follows...



Repeater (Multipoint)	Description	Manufacture/ Install date
Whakapunaki	VHF Voice	1987/1990
Whakapunaki	VHF Abbey	2000/2000
Kinikini	VHF Voice	1987/1990
Kinikini	VHF Abbey	1993/2000
Carnarvon St	VHF Voice	1990/1990
Carnarvon St	UHF Abbey	1999/1999
Umakuri (Tokomaru)	VHF Voice	1993/1993
Umakuri	UHF Abbey (Tokomaru)	2001/2001
Tikitiki	UHF Abbey (Ruatoria)	2001/2001
Tikitiki	VHF Voice	1993/1993
Tikitiki	VHF Abbey	2002/2002
Hicks Bay Hill	UHF Abbey	2001/2001
Hicks Bay Hill	VHF Voice	2010/2011
Mata Rd	VHF Voice	1993/1993
Mata Rd	VHF Abbey	1993/2000
Makaretu	VHF Abbey	1993/2000
Makaretu	VHF Voice	1993/1993
Makaretu	UHF Abbey (Puha)	2001/2001
Makaretu	VHF Abbey2	2001/2001
Arakihi	VHF Voice	1993/1993
Arakihi	UHF Abbey (Tolaga)	2001/2001
Arakihi	VHF Abbey	2001/2001
Waihi Stn on hill	UHF Abbey	2001/2001
Waihi Power Station- Waihi Hill/W1040	UHF Data	2010

Link (point to point)	Type	Manufacture Date
Gisborne - Makaretu	UHF 1+1 Backup	1993
Gisborne - Whakapunaki	UHF 1+1 Backup	1993
Gisborne(Matawhero) - Makaretu	4RF Digital Link /IP	2003

Makaretu - Arakihi	4RF Digital Link /IP	2009
Arakihi – Mata Rd	4RF Digital Link /IP	2010
Mata Rd – Umakuri	UHF 1+1 Data Voice	1995
Mata Rd – Tikitiki	UHF 1+1 Data Voice	1993
Tikitiki – Hicks Bay Hill	UHF 1+1 Data Voice	1993
Gisborne - Whakapunaki	4RF Digital Link /IP	2007
Whakapunaki – Kini Kini	UHF 1+1 Data Voice	2000
Whakapunaki - Arakihi	4RF Digital Link	2001

Communications cable (Note Significant circuits only)		Installed Date
Carnarvon St - Gisborne		1987
Gisborne - Kaiti		1986
Carnarvon St - Makaraka		1986
Carnarvon St – Bright St/ Plunket		1986
Carnarvon St Reads Quay		1986
Carnarvon St – Parkinson St / Birrel St		1986
Fibre Optic Circuits		
Makaraka - Parkinson St		2005
Parkinson St - JNL		2005
Port-Kaiti		2006
JNL - Matawhero		2005
Carnarvon St - Port		2005
Carnarvon St – Parkinson St		2005
RT's	Quantity	Ave purchase date
Handheld	10	1995-2010
Vehicle VHF Wide Band	30	1995
Substation/Automation sites UHF	9	2001
Substation/Automation sites VHF Narrow Band	100	2005

Pilot Isolation Facilities	No. of Circuits	Service	Installed Year
Carnarvon Street	9	Voice(4)/Data(5)	1995
Valley Rd	3	Not Used	1990's
Kaiti	2	Not Used	1990's
Parkinson St	2	Not Used	1990's
Makaraka	1	Not used	1990's
Wairoa	1	Telecom	2000
Kiwi	1	Telecom	1990's
Ngatapa	1	Telecom	1990's
Patutahi	1	Telecom	1990's
Pehiri	1	Telecom	1990's
Puha	1	Telecom	1990's
Ruatoria	1	Telecom	1990's
Te Araroa	1	Telecom	1990's
Tokomaru	1	Telecom	1990's
Tolaga	1	Telecom	1990's
Plunket Sub	1	Data	1980's
Bright St	1	Data	1980's
Reads Quay	1	Data	1980's
Birrel St	1	Data	1980's

The standard ODV maximum life assigned to communications equipment is 15 years. Modern equipment with more stable components and self tuning capability generally perform well during this life. Antennas and cables exposed to weather need more regular replacement (10 years). Usually technology advances make earlier system replacement desirable. The Wide-Band VHF Repeaters and RT's are programmed for renewal in 2012-2013 to coincide with changes required by changes to Radio Frequency allocations. The equipment will be changed to digital narrow band equipment.

The isolation equipment is required to isolate telecom connections and ENL's communication circuits from earth potential rise in fault conditions at major substations. The isolation facilities are designed to ensure safety of personnel and protection of connected equipment. Use of this equipment will be phased out as fiber-optic circuits replace the need for copper communications circuits.

The wireless broadband 2.4G and 5G communications network was installed between 2005 and 2006 the relationship between age and performance of this system has not been determined at this stage.

### **2.3.14 Other assets**

#### **2.3.14.1 Generation**

The age of standby generation assets is tabulated as follows...

Generators	Rating kVA	Manufacture Date
Carnarvon St	12	1960's
Makaretu	5	1960's
Arakihi	5	1960's
Mata Rd	5	1960's
Whakapunaki	5	1960's
Tikitiki	5	1960's

Condition is influenced by usage patterns and maintenance undertaken.

All fuel and safety systems for the generator installations were updated to align with regulatory changes in 2007.

Note Larger Standby Generation Units are owned by Eastland Generation Limited. Asset Management strategies for these units are outside the scope of this plan.

#### **2.3.14.2 Software**

The software assets are in a constant state of renewal and upgrade hence age of these systems is generally current. Currently all of the software systems in use are meeting the desired performance requirements and no significant upgrade is planned over the next 3 years. The GIS system is not compatible with 64 bit Windows 7 operating systems. This can be overcome by virtualisation software when necessary.

<b>Software</b>	<b>Version/Installed Year</b>
Gentrack Billing System	installed 2011
Powerview GIS	installed 2001
Finance –Accpac	Latest 2011
Fixed Assets- Activa	2011
Abbey Systems Scada	Latest Upgrade 2010
Microsoft Operating Sys Servers	2008
Microsoft Exchange	2010
GMAIL (redundancy)	2012
Microsoft Operating Sys PC's	XP- Win7
Microsoft Office	2010
PSS Sincal	2011
Protection software SEL	2010
Protection Software Uniserve	2010
Battery Charger Software	2011 Ice / DCtools
PLC Software Fanuc	2006 VersaPro /2010 Proficy
PLC Software Cscape	2008
Metering Software Email	2011
Loggers Codam DOS	1996
Loggers Polylogger	1998
PLC Software Rockwell	2011
Radio Software Aprisa	2002
Relays Enermet	2008
Relays Microtrip DOS	1998
Relays Polarr	1999
Relays Reg D	2012
Transducers Weidmuller	2012 XP only
Security Milestone	2010
Security Innerrange	2008
Config Software Moxa	2011
Config Software Mikrotik	2011
Controller PicAxe	2009
Config Software Adam	2010

### **2.3.15 Summary of assets with values**

The assets are summarised in Table 2.3(a).

**Table 2.3(a) – Summary of assets by category including value- 2009 Valuation**

Asset description	Quantity	Unit	Average age	Condition summary	ODRC	Percent of ODRC
Subtransmission line	335	km	29	Average	3556	2.75
Subtransmission Poles	2441	each	23	Average	9366	7.25
Subtransmission cable	2	km	6	Good	413	0.32
Other zone substation assets		total	9	New/good condition	6141	4.76
50/11kV and 33/11kV transformers	37	each		Average	5238	4.06
Distribution line	2411	Km	39	Condition Ageing	10925	8.46
Distribution Poles	24892	each	27	Condition Ageing	25945	20.09
Distribution cable	135	km	21	Above Average	10505	8.13
Voltage regulators	9	each		Average	438	0.34
Distribution Substations	3701	each	26	Average	5810	4.50
Distribution transformers	3509	each	24	Average	13166	10.19
Distribution Fuses	2856	each	26	Below Average	748	0.58
Distribution switchgear	1820	each	21	Above Average	12115	9.38
LV lines	540	Km	39	Ageing	5627	4.36
LV Poles	6550	each	28	Ageing	5073	3.93
LV cable	187	km	22	Average	9105	7.05
Communications		total	8	Technology determines Condition	758	0.59
SCADA & system control		total	6	Technology determines Condition	582	0.45
Connection assets	25421	each	26	Customer Drives upgrades	3636	2.82
<b>Total</b>			<b>24</b>		<b>129147</b>	

The disclosed ODV roll forward valuation in 2011 was \$117.405 million giving an overall increase of 4.4% p.a.

## **2.4 Justification for assets**

ENL creates stakeholder service levels by carrying out a number of activities (described in Section 5) on its assets, including the initial step of actually building assets such as lines and substations. Some of these assets obviously need to deliver greater service levels than others e.g. Carnarvon substation in industrial Gisborne has a higher capacity and security level than Tahaenui substation in rural Wairoa. Hence a greater level of investment will be required that generally reflects the magnitude and nature of the demand.

Ideally an asset can be justified if the service level it creates is equal to the service level required. In a practical world of asymmetric risks, discrete component ratings, non-linear behaviour of materials and uncertain future growth rates ENL considers an asset to be justified if its resulting service level is not significantly greater than that required subject to allowing for demand growth and discrete component ratings.

ENL matches the level of investment in assets to the expected service levels required as follows...

- Designs are developed by personnel with an understanding of how asset ratings and configurations create service levels such as capacity, security, reliability and voltage stability.
- The asymmetric nature of under-investment and over-investment is considered in line with relevant risk factors identified in section 6.2.3 to obtain an optimum balance. i.e. Over-investing creates service levels in excess of what is needed, but under-investing can lead to service interruptions (which typically costs about 10x to 100x as much as over-investing).
- Standards are used that define discrete "sizes" of the many classes of components that need to be recognised. The use of a minimum range of standard sizes for transformers poles and conductors reduces costs associated with stock holdings and spares and maintenance, which is also factored into the overall investment cost. In some cases capacity can be staged through use of modular components.
- Experienced personnel are involved to confirm predictions made to accommodate future demand growth, (noting that the ODV



Handbook now prescribes the number of years ahead that such growth can be accommodated).

A key practical measure of justification is level of optimisation required in the derivation of ENL's ODV. The ratio of ENL's ODRC to DRC from ENL's 2009 Valuation was 0.99, with a ratio close to 1 indicating a high level of justification. In addition the levels of investment in growth performance and security between 2000 and 2007 indicate a catch up suggesting insufficient investment previously.

Areas where over investment have previously required optimisation as per ODV definitions were:

- The predominant optimisation relates to Distribution Transformer capacity to obtain 0.3 demand capacity ratio. As there are a large number of small transformers in the rural network and the minimum economic size of each item is higher than that required to provide the required service levels the actual installed capacity results in a ratio lower than the allowable limit.
- Some 300mm cables (Heavy) were technically optimised to 185mm (Medium) however the cost difference between the two sizes at the time of installation was so small the actual over investment had been negligible.

## **3. Service levels**

### **3.1 Consumer-oriented service levels**

As part of both complying with regulatory quality threshold requirements and on-going engagement with its customers, ENL formally surveys and consults with stakeholder and customer representative groups. The primary required outcome of the consultation process is for ENL to receive feedback from customers on which attributes of supply are important to them, preferences for price and reliability and how well ENL is delivering those attributes and/or preferences. Responses received are then considered by Eastland Group's management team and significantly influence the setting of service levels.

To ensure objectivity is maintained, the consultation process is undertaken by an independent consultant.

Stakeholder/customer groups included in consultation were;

ENL's 26 largest customers, (by energy consumption)

A random selection of 2.5%, (485), of the mass market consumers pro-rated between Gisborne and Wairoa.

The following groups were also consulted

<b>Representative group</b>	<b>Interest</b>
Gisborne District Council	Ensuring that economic development initiatives are supported by a reliable and reasonably priced electricity supply.
Gisborne Chamber of Commerce	Ensuring that the business sector's interests of reliability and reasonable prices are looked after.
Gisborne Greypower	Ensuring that the elderly's (especially those on fixed incomes) interests of low prices are looked after.
Wairoa District Council	Ensuring that economic development initiatives are supported by a reliable and reasonably priced electricity supply.
Wairoa Greypower	Ensuring that the elderly's (especially

those on fixed incomes) interests of low prices are looked after.

The following charts summarise the responses received from the 2010 consultation round.

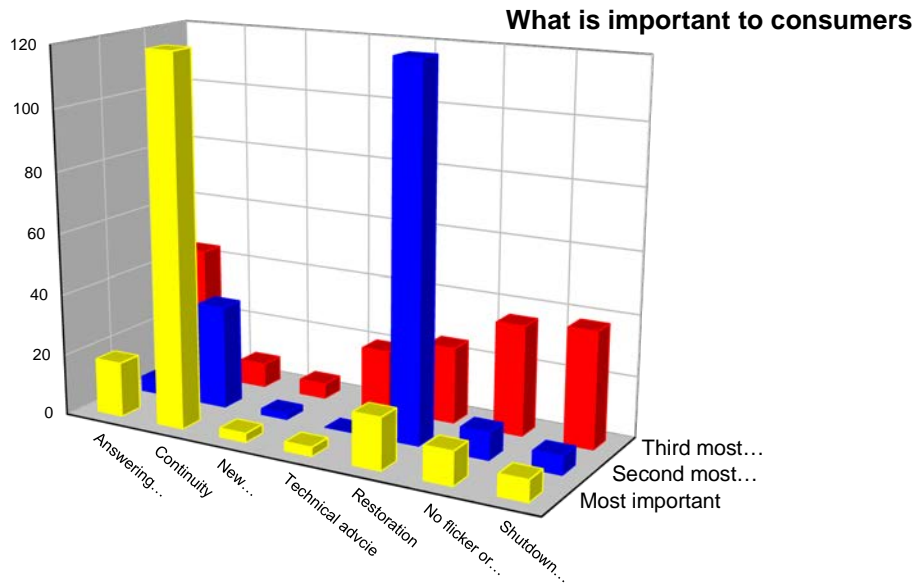

Performance against individual attributes

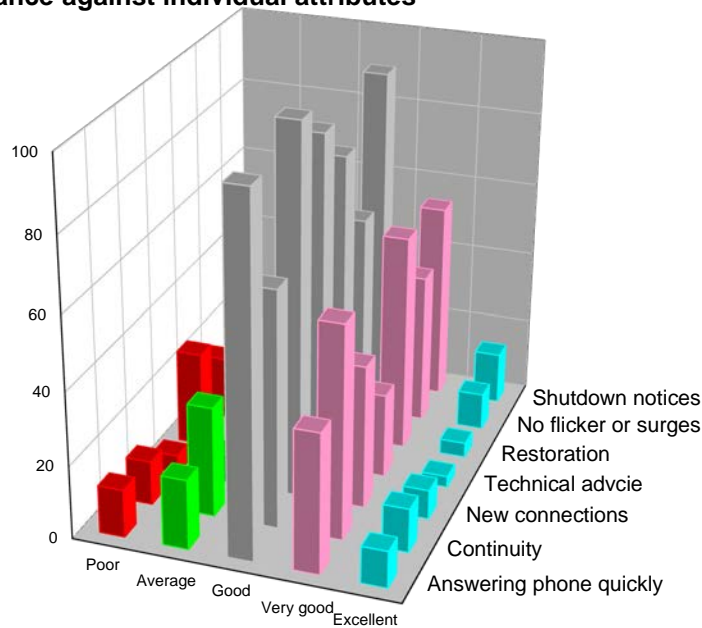

Performance against individual attributes (large consumers)

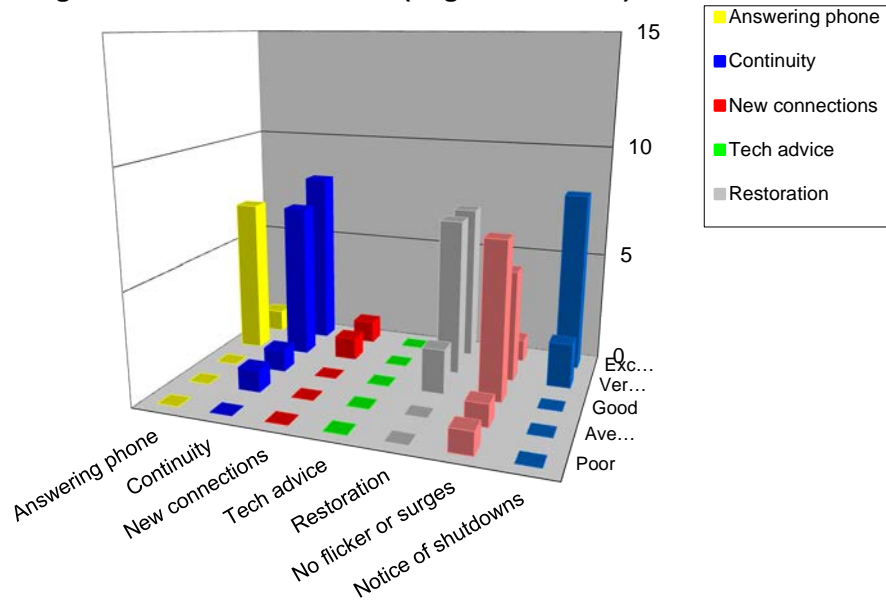

Preference for price and quality

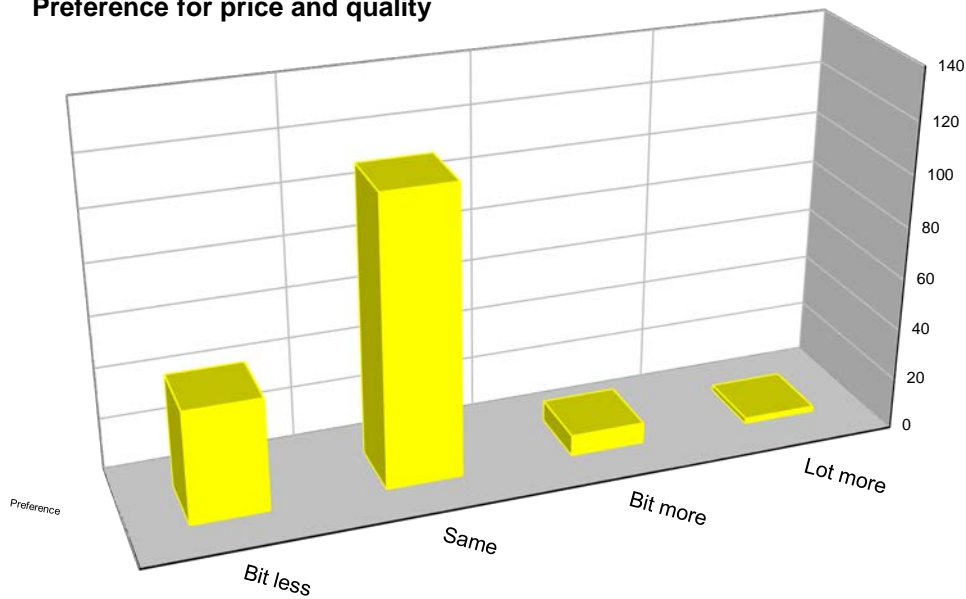

ENL's interpretation of the results from surveys to date indicate the Primary focus needs to be on supply interruptions and restoration times. Whether ENL improves or simply maintains these areas and whether line charges are increased to do so are addressed as follows...

- Continuity should be maintained at about the current levels or improve where it can without increasing line charges. ENL definitely shouldn't let continuity decline.
- ENL should maintain restoration performance at about the current levels, improve where it can without increasing line charges, but definitely shouldn't let restoration performance decline.
- ENL should maintain its timeliness and addressing accuracy of planned shutdown notices, improve where it can without increasing line charges, but it definitely shouldn't let performance decline.

### **3.1.1 Primary customer service levels**

ENL's customers have clearly signaled that continuity and restoration are the two operational performance attributes that they value the most and at a minimum ENL needs to maintain current levels of performance without increasing its line charges.

#### **Operational Performance**

To measure operational performance with respect to continuity and restoration, ENL in accordance with industry standard practice and the Information Disclosure and Electricity Distribution Threshold regimes, sets targets for the next five years against the following key indices;

- SAIDI – system average interruption duration index. The measure of how many system minutes of supply are interrupted per year.
- SAIFI – system average interruption frequency index. The measure of how many system interruptions occur per year.
- CAIDI – consumer average interruption duration index. This is an average measure of how long each connection has no supply per year.

Projections of the key network operational performance targets for the next 10 years are;

Measure	2011/12	2012/13	2013/14	2014/15	2015-2022
SAIDI	285	307	307	307	307
SAIFI	4.0	4.2	4.2	4.2	4.2
CAIDI	71	73	73	73	73

In accordance with the Commerce Commission Targeted Control Regime for lines businesses ENL is required to comply with a quality threshold. This means its annual SAIDI and SAIFI performance cannot exceed the current set 5 year averages of SAIDI = 302 and SAIFI = 4.2.

ENL has set the same SAIDI, SAIFI and CAIDI targets for the planning period as a driver to achieve a level of sustainable steady state performance that considers network asset age/location/configuration, financial implications and customer expectations. Investment to improve service beyond steady state and regulated levels is seen as over investment and as such cannot be justified.

A shortfall in achievable renewal investment versus required renewal rates is forecast to result in the average age of the network increasing. Should this occur there is a risk of reduction in the service levels.

Given the relatively small asset base there is high degree of uncertainty in the validity of the forecast predictions.

Complimentary to key operational performance targets are targets for the restoration of faults which affect the supply to customers. ENL's targeted performance is to meet the targets as prescribed in current Use of System Agreements entered into with energy retailers. These minimum targets are;

**Fault Restoration**

Urban	4 hours
Rural	8 hours

An exception to these targets can occur where private lines have failed or where hazards exist that prevent private lines from being restored, until the hazards have been corrected. This situation typically occurs where trees have encroached into the safety zone on private lines.

The control operations staff and/or faults service contractor record response times and the causes for the network outages defined by the disclosure rules, in the System Outage database which facilitates analysis and disclosure reporting. For outages that are excluded from the disclosure requirements information is recorded on the fault response documentation. An Engineering officer is responsible for reviewing the recorded figures and implementing improvements or corrective action when necessary. Comparisons of the response times are made with benchmark values to indicate trends. Outage duration and repair time components are incorporated into the performance indices for industry benchmarking.

## Line Function Services Charges

Customer consultation has determined that in general ENL's customers are satisfied with the current level of network operational performance and are unwilling to pay for improved performance. However, ENL is faced with two significant issues that fundamentally affect how the business will be operated and managed in the future to deliver even the minimum levels of service:

1. It has a network that has been identified as being relatively old, with a significant level of assets nearing the end of the lives;
2. It has faced on-going and significant erosion of the businesses Return on Investment (ROI).

Eastland Network has identified a developing gap between required renewal rates to maintain asset age and current targeted rates, primarily limited by available funding. This is compounded by a distribution network that is spread over a large geographic area and characterised by a low density of less than seven connections per kilometre of line.

ENL's service level with respect to lines charges is that lines charges need to be sufficient to provide for the correct level of investment and return on the network, which in turn allows customer service level requirements to be met. Over the past few years, ENL has been working to address diminishing ROI through increasing prices. This is now at a point where ENL has an ROI for 2010/11 pricing of 11.3% which is mid pack when considering all lines businesses.

From 1 April 2010, a new regulatory period began under the Commerce Act. This is administered by the Commerce Commission using a CPI-X mechanism. For the 2011/12 financial year, an industry wide X-factor of 0% was put in place allowing prices to rise in line with CPI.

The completion of the Input Methodologies for 2012/13 pricing was deferred in 2011. As a result ENL has by default applied an X-factor of 0% to the 2012/13 pricing.

Following the completion of the Input Methodologies lines businesses are able to apply for a customized price path that may allow prices to be set which are higher than allowed under the current regulation. Eastland Network will monitor the situation under the new rules before

deciding whether to make such an application. If ENL's ROI continues to degrade, then this must be seen as having a strong likelihood.

### **3.1.2 Secondary customer service levels**

Secondary service levels are the attributes of service that ENL's consumers ranked below the attributes of supply continuity and restoration, and line function services charges. A key point to note is that most of these service levels are process driven which has two implications...

- They tend to be cheaper than fixed asset solutions e.g. someone could work a few hours overtime to process a back log of new connection applications.
- There are heterogeneous in nature i.e. they can be provided exclusively to consumers who are willing to pay more in contrast to fixed asset solutions which will equally benefit all consumers connected to an asset regardless of whether they pay.

The attributes of service which customers have ranked as secondary in importance and which ENL sets and monitors performance against targets are;

- Shutdown notification and coordination.  
To provide notification timing and shutdown advice in accordance with current Use of System Agreements, ENL has implemented the industry standard pro-forma email notification process. This process identifies affected ICPs and standardized information is emailed to relevant energy retailers. The energy retailers in turn advise their customers accordingly.  
When organizing a shutdown, ENL directly contacts large and significant customers, (e.g. rest homes) to discuss and negotiate outage times which as much as possible are set to accommodate the preferences of those customers.
- How quickly ENL processes Network Alteration applications for new connections, changes in required capacity or total disconnection.
- How promptly and how well ENL provides technical advice to consumers on network asset related issues.



- How promptly and how well ENL responds to quality of supply issues. The quality of supply is measured in terms of voltage flicker complaints, low voltage issues, harmonic content in supply, interference to telecommunication assets and radio interference. The legislation and regulations that determine ENL supply quality requirements include The Electricity Act 1992, Electricity Regulations 1997 and The Commerce Act 1986. Deviations from regulatory limits and poor supply quality levels are recorded in the network defects database as soon as they are identified. Corrective actions are carried out as soon as practicable. Issues requiring longer term supply quality improvement to the network asset are incorporated into the company design standards and management plans for the affected asset categories.
- How prompt and effective ENL's Complaint and Dispute Resolution Process is. ENL is an electricity company member of the complaints scheme administered by the Electricity & Gas Complaints Commission. Accordingly ENL is compliant with the Commission's Code of Practice for Electricity Companies and its Complaint and Dispute Resolution Procedure. ENL performance targets are aligned with those of the Commission.

ENL secondary customer service level performance targets for the next 10 years are;

Attribute	Measure	2011-2021
Notification of Planned Outages	Number of planned outages not notified to energy retailers at least 10 working days in advance.	0
	Number of individual ICP omissions or errors in outage notification to energy retailers.	0
	Number of large or significant customers not consulted directly during outage planning.	0

Processing of Network Alteration applications	Number of working days to process correctly completed applications for a new domestic or small commercial supply where infrastructure, capacity or resource consent issues do not exist.	5
	Number of working days to process correctly completed applications for load increases/decreases for existing domestic or small commercial ICPs where infrastructure, capacity or resource consent issues do not exist.	5
Provision of technical advice	Number of working days to acknowledge inquiry.	2
	Number of working days to investigate and respond to a customer inquiry.	20
Supply Quality issues	Number of working days to acknowledge a customer reported supply quality issue and initiate an investigation.	5
Complaints Procedure	Number of working days ENL has to acknowledgement that a complaint has been received from a customer.	2
	Number of working days to when an unresolved dispute is deemed deadlocked.	20
	Number of working days to when an unresolved dispute is deemed deadlocked. (with ENL having advised that additional investigation time is required)	40

### **3.1.3 Other Stakeholder service levels**

In addition to the service levels that are of primary and secondary importance to consumers, ENL has safety and environmental management service levels that benefit stakeholders.

**3.1.3.1 Safety**

Eastland Group is committed to providing and maintaining a safe and healthy environment for all of its employees, contractors, customers and the public.

Eastland Group’s regulatory and corporate responsibilities for health & safety management across the businesses it manages are described in the Eastland Group Health & Safety Manual. This manual also determines for each business the health & safety management policies and procedures required to be implemented to meet those responsibilities. In addition a safety management system required under regulation exists to ensure specific processes are in place to ensure prevention of serious harm to the public and/or significant damage to property.

In all over 100 documents have been identified that contain compliance requirements associated with operation maintenance and reporting for the Network Assets.

The key regulations and industry codes of practice that ENL has a responsibility to comply with are;

- Health & Safety in Employment Act 1992.
- Electricity (Hazards from Trees) Regulations.
- Maintaining safe clearances from live conductors (NZECP34:2001).
- Power system earthing (NZECP35:1993).
- Safety Manual –Electricity Industry
- Electricity Act
- Electricity (Safety) Regulations

Key elements of the Eastland Group Health & Safety Manual and Safety Management system which ENL implements are;

- Workplace Hazard Management
- Contractor Health & Safety Management
- Public Safety – Asset Hazard Management

As drivers to achieve the Eastland Group safety policy standards of safety performance, ENL has set the following targets for every year of the planning period and beyond;

Event / Incident Description	Target
Serious Harm Employees Contractors /Lost Time	0
Serious Harm Public	0
Serious Damage Company Property and Equipment	0

Serious Damage Public Property	0
Near Miss Harm Employees Contractors	NA
Near Miss Harm Public	NA
Near Miss Damage Company Property and Equipment	NA
Near Miss Damage Public Property and Equipment (HV Power faults)	NA

Safety performance reporting to the ENL Board of Directors is undertaken at every monthly Board Meeting.

### **3.1.3.2 Environmental management**

In planning and undertaking activities which have implications for the environment, Eastland Group is committed to managing and operating its businesses in a manner which meets the community's environmental expectation. For ENL this requires a balance be met between the community's need for electricity and that of effective environmental management.

ENL has the environmental management performance target of full compliance with all laws, regulations, resource consent and local authority District Plan conditions.

## **3.2 Industry and Business performance targets**

As a monopoly lines business ENL is required to disclose a range of internal performance and efficiency measures as required by the Electricity (Information Disclosure) Requirements. ENL aligns future performance targets against the Disclosure measures. The measures which are applied to target asset management performance are described below;

The peer/benchmark values for the industry are published annually by Price Waterhouse Coopers (refer [www.pwc.co.nz](http://www.pwc.co.nz))

### **3.2.1 Asset performance**

Complimentary to the primary customer service levels for SAIDI, SAIFI and CAIDI, Section 3.1.1, ENL also forecasts and monitors network performance via the number of faults per 100km for both overhead and underground assets at per asset voltage category. This targeted performance for the next ten years is;

SERVICE PERFORMANCE TARGETS
-----------------------------

	2010/11Actual	2011/12	2012/13	2013/14	2014/15	2015/16	2016/17	2017-2022
<b>Interruptions</b>								
B Planned	169	180	180	180	180	180	180	180
C Unplanned	328	280	280	280	280	280	280	280
<b>Faults/100km</b>								
Total								
50 kV	4.64	1.66	1.66	1.66	1.66	1.66	1.66	1.66
33 kV	5.81	2.91	2.91	2.91	2.91	2.91	2.91	2.91
11 kV	12.29	10.76	10.76	10.76	10.76	10.76	10.76	10.76
Total	11.40	9.71	9.71	9.71	9.71	9.71	9.71	9.71
<b>Underground</b>								
50 kV	0.00	0.00	0.00	0.00	0.00	0.00	0.00	0.00
33 kV	0.00	0.00	0.00	0.00	0.00	0.00	0.00	0.00
11 kV	9.82	7.51	7.51	7.51	7.51	7.51	7.51	7.51
Total	9.72	7.43	7.43	7.43	7.43	7.43	7.43	7.43
<b>Overhead</b>								
50 kV	4.66	1.66	1.66	1.66	1.66	1.66	1.66	1.66
33 kV	5.83	2.0	2.0	2.0	2.0	2.0	2.0	2.0
11 kV	12.43	10.94	10.94	10.94	10.94	10.94	10.94	10.94
Total	11.49	9.83	9.83	9.83	9.83	9.83	9.83	9.83
<b>SAIDI</b>								
Total	334	307	307	307	307	307	307	307
B Planned	76.6	65	65	65	65	65	65	65
C Unplanned	257.39	242	242	242	242	242	242	242
<b>SAIFI</b>								
Total	3.48	4.2	4.2	4.2	4.2	4.2	4.2	4.2
B Planned	0.33	0.40	0.40	0.40	0.40	0.40	0.40	0.40
C Unplanned	3.15	3.80	3.80	3.80	3.80	3.80	3.80	3.80
<b>CAIDI</b>								
Total	95.97	73	73	73	73	73	73	73
B Planned	232	162	162	162	162	162	162	162
C Unplanned	81.71	64	64	64	64	64	64	64

### Notes

1. 2011/12 Actual values are not yet available
2. Data excludes Private and Transpower outages
3. Targeted Control Regime 5 Year Average SAIDI = 302 , SAIFI = 4.2

### **3.2.1 Financial efficiency measures**

ENL's projected financial efficiency measures are shown below. These measures are...

- Operational Expenditure per km of line
- Operational Expenditure per ICP

Where operational expenditure is the expenditure incurred in the operation of the distribution business, and that is not Capital Expenditure and excludes depreciation, tax, expenditure on transmission and expenditure relating to financing the business.

Financial efficiency Measures								
	2010/11Actual	2011/12	2012/13	2013/14	2014/15	2015/16	2016/17	2017-2022
Direct costs \$/km	1594	1700	1700	1700	1700	1700	1700	1700
Indirect costs \$/ICP	228	240	240	240	240	240	240	240

2010/11 Information Disclosure industry averages, Operational Expenditure per km = \$2969, Indirect Costs = \$227/ICP.

While other measures are directly associated with performance of the network assets these targets are determined from both impacts relating to asset management activities and the impact of other strategic and business initiatives unrelated to asset management.

### **3.2.2 Energy delivery efficiency measures**

ENL's projected energy efficiency measures are shown below. These measures are...

- Load factor –  $\frac{[\text{kWh entering the network during the year}]}{[[\text{max demand for the year}] \times [\text{hours in the year}]]}$ .
- Loss ratio –  $\frac{[\text{kWh lost in the network during the year}]}{[\text{kWh entering the network during the year}]}$ .
- Capacity utilisation –  $\frac{[\text{max demand for the year}]}{[\text{installed transformer capacity}]}$ .

It should be noted that the energy delivery efficiency parameter values achieved are predominately determined by the network configuration and assets required to supply the demand profiles of customers. Over the next ten years ENL expects to maintain a sustainable steady state position with respect to energy delivery efficiency delivery. Tactics to achieve this are described in Section 5.0.

Measure	2010/11 Actual	2011/12	2012/13	2013/14	2014/15	2015/16	2016/17	2017-2022
Load factor	61.0%	62%	62%	62%	62%	62%	62%	62%
Loss ratio	6.6%	6 %	6 %	6 %	6 %	6 %	6 %	6 %
Capacity utilisation	23.3%	23%	23%	23%	23%	23%%	23%	23%

2010/11 Information Disclosure industry averages, Load Factor = 59.6%; Loss Ratio = 5.5%; Capacity Utilization = 31.3%.

The above average load factor indicates that the load characteristic of the region is more variable than other areas with a higher base load characteristic. The above average loss ratio reflects the low density long line length characteristic of the region. The below average capacity utilisation reflects the low density connections using minimum size transformers that are larger than necessary. In general the results are in line with expected levels.

### **3.3 Justification of service levels**

Historical trends for key service levels in Section 8 of this plan show the extent of variation between good and bad years can be in the order of 50%. While comparison of targets over a short time base may suggest little incentive is in place for improvement ENL has considered the entire asset life cycle and short term variance when setting the steady state targets. When the targets are aligned over a time frame equivalent to the asset life there is a significant incentive in place to improve designs and methods to improve service levels where possible.

ENL's service levels are justified through consideration of the following;

- By what is achievable and sustainable within current revenue boundaries. This is the primary consideration affecting the ability to set and achieve marked improvement in future performance. In line with customer survey conclusions improvements to the availability and reliability of supply to customers with no increase in cost significantly limits options for improvement of the asset to a level that dramatically enhances service levels, hence performance

improvement will be gradual and lower than the levels of annual variation.

- By the physical characteristics and configuration of the assets which comprise the network and which are difficult and expensive to significantly alter (but which can be altered if a consumer or group of consumers agrees to pay for the alteration). As with other lines businesses ENL has legacy decisions which have established service levels that would require significant additional investment to alter. Examples include the use of second hand 50kV insulators in the 1960's that are now impacting on reliability and the construction of distribution lines across country as opposed to alongside accessible roads.
- Through consideration of customer consultation results and the subsequent analysis to determine the customer's primary service level requirements and their agreement to pay.
- Achieving compliance with all legislative and regulatory requirements applicable to the ownership and operation of the network. This includes when an external agency imposes a service level on ENL (or in some cases an unrelated condition or restriction that manifests as a service level such as requirement to place new lines underground)

When establishing performance levels ENL carried out a comparison against other lines businesses for the purpose of determining its desired position in the market.

Analysis and consideration of previous information disclosures published annually by Price Waterhouse Coopers (refer [www.pwc.co.nz](http://www.pwc.co.nz)) is undertaken to confirm ENL is aligned with its peers.

In general service levels have been set to maintain ENL in an average industry position.





## **4. Development plans**

ENL's development plans are driven almost totally by demand but on occasions may be influenced by other drivers, primarily security of supply.

At the most fundamental level, demand is created by each individual consumer, using energy via their individual connection. The demand at each connection aggregates "up the network" to the distribution transformer, then to the distribution network, the zone substation, the sub-transmission network back to the GXP and ultimately through the grid to a power station.

### **4.1 Planning approach & criteria**

#### **4.1.1 Planning unit**

ENL has adopted the 11kV distribution feeder as its fundamental planning unit which typically represents one or perhaps two of the following combinations of consumer connections...

- An aggregation of up to 1,000 urban domestic consumer connections.
- An aggregation of up to 300 urban commercial consumer connections.
- An aggregation of up to 20 or 30 urban light industrial consumer connections.
- An aggregation of anywhere from 20 to 100 rural domestic or farm consumer connections.
- A single large industrial consumer connection.
- Injection of up to 5MW of generation (e.g. Waihi and the diesel generators).

Physically this planning unit will usually be based around the lines or cables emanating from an 11kV switchboard.

#### **4.1.2 Planning approaches**

ENL tends to plan development of its assets in three different ways (strategically, tactically and operationally) as shown below...

## Planning approaches

Attribute	Strategic	Tactical	Operational
Asset description	<ul style="list-style-type: none"> <li>Assets within GXP.</li> <li>Sub-transmission lines &amp; cables.</li> <li>Major zone substation assets.</li> <li>Load control injection plant.</li> <li>Central SCADA &amp; telemetry.</li> <li>Generation Connections</li> <li>Distribution configurations e.g. Decision to link or divide feeders.</li> </ul>	<ul style="list-style-type: none"> <li>Minor zone substation assets</li> <li>All individual distribution lines (11kV)</li> <li>All distribution line hardware.</li> <li>All on-network telemetry and SCADA components.</li> <li>All distribution transformers and associated switches.</li> <li>All HV consumer connections.</li> </ul>	<ul style="list-style-type: none"> <li>All 400V lines and cables.</li> <li>All 400V consumer connections.</li> <li>All consumer metering and load control assets.</li> </ul>
Number of consumers supplied.	<ul style="list-style-type: none"> <li>Anywhere from 500 to about 7,500</li> </ul>	<ul style="list-style-type: none"> <li>Anywhere from 1 to about 500.</li> </ul>	<ul style="list-style-type: none"> <li>Anywhere from 1 to about 50.</li> </ul>
Impact on balance sheet and asset valuation.	<ul style="list-style-type: none"> <li>Individual impact is low.</li> <li>Aggregate impact is moderate.</li> </ul>	<ul style="list-style-type: none"> <li>Individual impact is moderate.</li> <li>Aggregate impact is significant.</li> </ul>	<ul style="list-style-type: none"> <li>Individual impact is low.</li> <li>Aggregate impact is moderate.</li> </ul>
Degree of specificity in plans.	<ul style="list-style-type: none"> <li>Likely to be included in very specific terms, probably accompanied by an extensive narrative.</li> </ul>	<ul style="list-style-type: none"> <li>Likely to be included in specific terms, and accompanied by a paragraph or two.</li> </ul>	<ul style="list-style-type: none"> <li>Likely to be included in broad terms, with maybe a sentence describing each inclusion.</li> </ul>
Level of approval required.	<ul style="list-style-type: none"> <li>Approved in principal in annual business plan.</li> <li>Individual approval by board and possibly shareholder.</li> </ul>	<ul style="list-style-type: none"> <li>Approved in principal in annual business plan.</li> <li>Individual approval by chief executive.</li> </ul>	<ul style="list-style-type: none"> <li>Approved in principal in annual business plan.</li> <li>Individual approval by GM - Operations.</li> </ul>
Characteristics of analysis.	<ul style="list-style-type: none"> <li>Tends to use one-off models and analyses involving a significant number of parameters and extensive sensitivity analysis.</li> </ul>	<ul style="list-style-type: none"> <li>Tend to use established models with some depth, a moderate range of parameters and possibly one or two sensitivity analyses.</li> </ul>	<ul style="list-style-type: none"> <li>Tends to use established models based on a few significant parameters that can often be embodied in a "rule of thumb".</li> </ul>

To further guide its thinking ENL has developed the following “investment strategy matrix” shown in Figure 4.1.2(b) which broadly defines the nature and level of investment and the level of investment risk implicit in different circumstances of growth rates and location of growth.

**Figure 4.1.2(b) – Investment strategy matrix**

Location of demand growth	Outside of existing network footprint	<p><b>Quadrant 3</b></p> <ul style="list-style-type: none"> <li>• CapEx will be dominated by new assets that require both connection to existing assets and possibly upstream reinforcement.</li> <li>• Likely to absorb lots of cash – may need capital funding.</li> <li>• Easily diverts attention away from legacy assets.</li> <li>• Likely to result in low capacity utilisation unless modular construction can be adopted.</li> <li>• May have high stranding risk.</li> </ul>	<p><b>Quadrant 4</b></p> <ul style="list-style-type: none"> <li>• CapEx will be dominated by new assets that require both connection to existing assets and possibly upstream reinforcement.</li> <li>• Likely to absorb lots of cash – may need capital funding.</li> <li>• Easily diverts attention away from legacy assets.</li> <li>• Need to confirm regulatory treatment of growth.</li> <li>• May have a high commercial risk profile if a single customer is involved.</li> </ul>	
	Within existing network footprint	<p><b>Quadrant 1</b></p> <ul style="list-style-type: none"> <li>• CapEx will be dominated by renewals (driven by condition).</li> <li>• Easy to manage by advancing or deferring straightforward CapEx projects.</li> <li>• Possibility of stranding if demand contracts.</li> </ul>	<p><b>Quadrant 2</b></p> <ul style="list-style-type: none"> <li>• CapEx will be dominated by enhancement rather than renewal (assets become too small rather than worn out).</li> <li>• Regulatory treatment of additional revenue arising from volume thru' put as well as additional connections may be difficult.</li> <li>• Likely to involve tactical upgrades of many assets</li> </ul>	
		Lo	Prevailing load growth	Hi

ENL’s current demand growth falls mainly in Quadrants 1 and 2 as follows...

**Quadrant 1**

Areas such as Matawai, Raupunga, Waikaremoana and the semi-rural areas around Wairoa are quite clearly in this quadrant – there is little if any growth so investment tends to be dominated by Renewal i.e. assets “wear out” rather than get “too small”. The potential for the population to decline particularly in the Wairoa District increases the risk of stranding assets.

## **Quadrant 2**

Areas such Makaraka, Matawhero, the Gisborne industrial estate, the Kaiti / Port area of Gisborne and the Mahia Peninsula are clearly in this quadrant – growth is high but it is largely within or very close to the existing network footprint. As ENL further examines in section 4.3.2 the impending forestry maturity cycle could drive very significant growth around Matawhero over the next 5 to 20 years if the logs are processed in the district instead of simply exported.

Investment in this quadrant tends to be dominated by Up-sizing rather than Renewal i.e. Assets get “too small” rather than “wear out”.

### **4.1.3 Trigger points for planning new capacity**

Because new capacity has ODV, balance sheet, depreciation and ROI implications, ENL will meet demand by other, less investment-intensive means. This discussion also links strongly to the discussion of asset life cycle in section 5.1.

The first step in meeting future demand is to determine if the projected demand will exceed any of the defined trigger points for asset location, capacity, reliability, security or voltage. These points are outlined for each asset class in Table 4.1.3(a).

If and only if a trigger point is exceeded does ENL then move to identify a range of options to bring the assets’ operating parameters back to within the acceptable range of trigger points. These options are described in section 4.2 which also defines a preference for avoiding new investment unless a commercial return is certain.

**Table 4.1.3(a) – Summary of planning “trigger points”**

Asset category	Location trigger	Capacity trigger	Reliability trigger	Security trigger	Voltage trigger
LV lines & cables	<ul style="list-style-type: none"> <li>Existing LV lines and cables don't reach the required location.</li> </ul>	<ul style="list-style-type: none"> <li>Not applicable – tends to manifest as voltage constraint.</li> </ul>	<ul style="list-style-type: none"> <li>Operational performance/reliability outside industry stds.</li> </ul>	<ul style="list-style-type: none"> <li>Not applicable.</li> </ul>	<ul style="list-style-type: none"> <li>Voltage at consumers' premises consistently drops below 0.94pu.</li> </ul>
Distribution substations	<ul style="list-style-type: none"> <li>Substation is not efficiently located in relation to load.</li> </ul>	<ul style="list-style-type: none"> <li>Where fitted, MDI reading exceeds 80% of nameplate rating.</li> </ul>	<ul style="list-style-type: none"> <li>Operational performance/reliability outside industry stds.</li> </ul>	<ul style="list-style-type: none"> <li>Excursion beyond triggers specified in section 4.2.2</li> </ul>	<ul style="list-style-type: none"> <li>Voltage at LV terminals consistently drops below 1.0pu.</li> </ul>
Distribution lines & cables	<ul style="list-style-type: none"> <li>Load cannot be reasonably supplied by LV configuration therefore requires new distribution lines or cables and sub.</li> </ul>	<ul style="list-style-type: none"> <li>Conductor current consistently exceeds 66% of thermal rating for more than 3,000 half-hours per year.</li> <li>Conductor current exceeds 100% of thermal rating for more than 10 consecutive half-hours per year.</li> </ul>	<ul style="list-style-type: none"> <li>Operational performance/reliability outside industry stds.</li> </ul>	<ul style="list-style-type: none"> <li>Excursion beyond triggers specified in section 4.2.2</li> </ul>	<ul style="list-style-type: none"> <li>Voltage at HV terminals of transformer consistently drops below 10.5kV and cannot be compensated by local tap setting.</li> </ul>
Zone substations	<ul style="list-style-type: none"> <li>Substation is not efficiently located in relation to load.</li> </ul>	<ul style="list-style-type: none"> <li>Max demand consistently exceeds 100% of nameplate rating.</li> </ul>	<ul style="list-style-type: none"> <li>Operational performance/reliability outside industry stds.</li> </ul>	<ul style="list-style-type: none"> <li>Excursion beyond triggers specified in section 4.2.2</li> </ul>	<ul style="list-style-type: none"> <li>Distribution voltage depression cannot be compensated for locally</li> </ul>
Sub-transmission lines & cables	<ul style="list-style-type: none"> <li>Load cannot be reasonably supplied by distribution configuration therefore requires new sub-trans lines or cables and zone sub.</li> </ul>	<ul style="list-style-type: none"> <li>Conductor current consistently exceeds 66% of thermal rating for more than 3,000 half-hours per year.</li> <li>Conductor current exceeds 100% of thermal rating for more than 10 consecutive half-hours per year.</li> </ul>	<ul style="list-style-type: none"> <li>Operational performance/reliability outside industry stds.</li> </ul>	<ul style="list-style-type: none"> <li>Excursion beyond triggers specified in section 4.2.2</li> </ul>	<ul style="list-style-type: none"> <li>Voltage depression that cannot be compensated for at GXP.</li> </ul>

## **4.2 Prioritisation methodology**

Development projects are prioritised in the following order of precedence...

1. Projects to address a short fall in demand from existing connections.
2. Projects to re-establish security levels following increases in demand.
3. Projects to provide for new load at existing connections
4. Projects to provide for new connections.

Where development projects are linked with other work the order of precedence above is qualified by consideration of the Action Plan Priorities Ranked by Risk Reduction Outcomes assessment in section 6.2.3.

### **4.2.1 Development Options for meeting demand**

Table 4.1.3(a) defines the trigger points at which the capacity of each class of assets needs to be increased. Exactly what is done to increase the capacity of individual assets within these classes can take the following forms (in a broad order of preference)...

- Defer while monitoring risk and simply accept that one or more parameters have exceeded a trigger point. This option would only be adopted if the benefit-cost ratio of all other reasonable options were unacceptably low and if assurance was provided to the chief executive that the option to defer did not represent an unacceptable increase in risk to ENL. An example of where this option might be adopted is where the voltage at the far end of a remote rural feeder is unacceptably low for a short period at the height of the holiday season – the benefits of correcting such a constraint are simply too low.
- Operational activities, in particular switching on the distribution network to shift load from heavily-loaded to lightly-loaded feeders to avoid new investment or winding up a tap changer to mitigate a voltage problem. The downside to this approach is that it may

increase line losses, reduce security of supply, or compromise protection settings.

- Influence consumers to alter their consumption patterns so that assets perform at levels below the trigger points. Examples might be to shift demand to different time zones, negotiate interruptible tariffs with certain consumers so that overloaded assets can be relieved, or assist a consumer to adopt a substitute energy source to avoid new capacity. Currently the ability to implement Demand Side Management initiatives is somewhat hampered by lines companies not having direct relationships with end user customers.
- Construct distributed generation so that adjacent assets performance is restored to a level below their trigger points. Distributed generation would be particularly useful where additional capacity could eventually be stranded or where primary energy is going to waste e.g. Waste steam from a process.
- Modify an asset so that the assets trigger point will move to a level that is not exceeded e.g. by adding forced cooling. This is essentially a sub-set of the above approach, but will generally involve less expenditure. This approach is more suited to larger classes of assets such as 50/11kV transformers.
- Retrofitting high-technology devices that can exploit the features of existing assets (including the generous design margins of a bygone era). Examples might be using remotely switched air-breaks to improve reliability, or using advanced software to thermally re-rate heavily-loaded lines.
- Install new assets with a greater capacity that will increase the assets trigger point to a level at which it is not exceeded. An example would be to replace a 200kVA distribution transformer with a 300kVA so that the capacity is not exceeded.

In identifying solutions for meeting future demands for capacity, reliability, security and voltage ENL considers options that cover the above range of categories. The benefit-cost ratio of each option is considered (including estimates of the benefits of environmental compliance and public safety) and the option yielding the greatest benefit is adopted. ENL uses the model in figure 4.2.1(a) to broadly guide ENL's adoption of various approaches...



**Figure 4.2.1(a) – Options for increasing capacity**

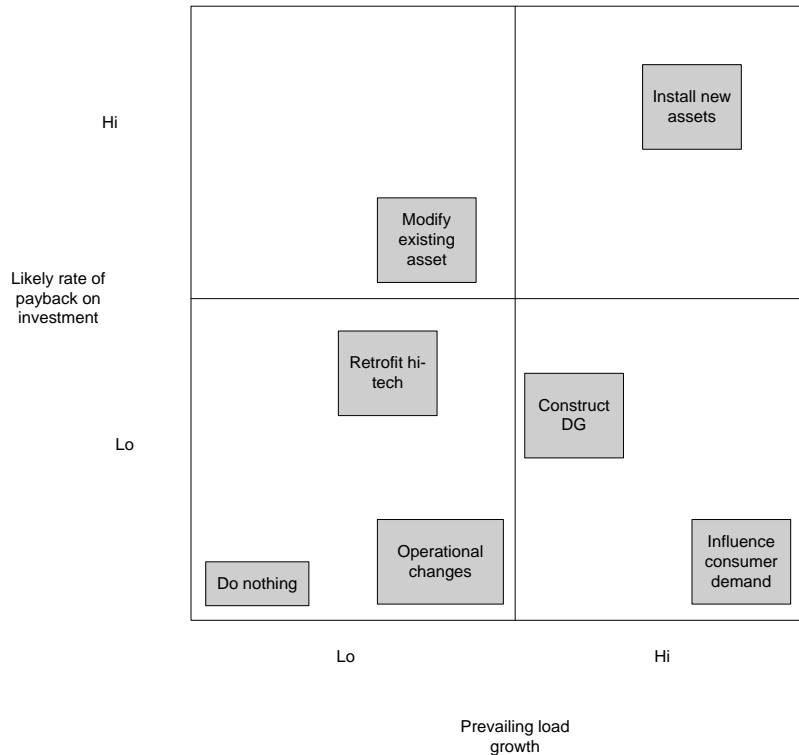

**4.2.2 Development options for meeting security requirements**

A key component of security is the level of redundancy that enables supply to be restored independently of repairing or replacing a faulty component. Typical approaches to providing security to a zone substation include...

- Provision of an alternative sub-transmission circuit into the substation, preferably separated from the principal supply by a bus-tie.
- Provision to back-feed on the 11kV from adjacent substations where sufficient 11kV capacity and interconnection exists. This obviously requires those adjacent substations to be restricted to less than nominal rating.
- Use of local generation.

The most pressing issue with security is that it involves a level of investment beyond what is obviously required to meet current demand. In general it is necessary to allow increases in demand to erode security levels beyond trigger levels thereby increasing risk, then invest in new asset to restore the security levels and allow for future growth. Hence demand growth and security essentially overlap throughout the development cycle.

#### **4.2.2.1 Prevailing security standards**

The commonly adopted security standard in New Zealand is the EEA Guidelines which reflect the UK standard P2/5 that was developed by the Chief Engineer's Council in the late 1970's. P2/5 is a strictly deterministic standard i.e. It states that "this amount and nature of load will have this level of security".

Deterministic standards have largely given way to probabilistic standards in which and the failure rate of supply components is estimated to determine the impact on performance targets providing comparative investment levels between multiple projects, to avoid interruption. The disadvantage of this approach is that, in terms of investment cost to performance improvement, investment in remote groups of connections rather than a single large industrial connection is favored. This is balanced by weighting the decisions based on the importance of the load to the wider community eg. Pumps, Hospitals and Schools and the contribution/income provided by the large single customer loads. The risk matrix approach shown in section 6.3 is used to assess or balance the decisions relating to security standards.

#### **4.2.2.2 Issues with deterministic standards**

A key characteristic of deterministic standards such as P2/5 and the EEA Guidelines is that rigid adherence generally results in at least some degree of over investment.

#### **4.2.2.3 Contribution of local generation to security**

To be of any use from a security perspective, local generation would need to have 100% availability which is unlikely from a reliability perspective and even less likely from a primary energy perspective such as run-of-the-river hydro, wind or solar. For this reason the emerging UK standard P2/6 provides for minimal contribution of such generation to security.

## 4.2.2.4 ENL's security standards

ENL's security standards below provide the base security criteria applied to all network design.

Class	Range of group peak demand (GPD) MVA	No. of customers effected	Security Level	Contingent Capacity	Time to restore after 1 <sup>st</sup> event	Time to restore after 2 <sup>nd</sup> event
D	More than 25MVA i.e. transmission, GXP or sub-transmission rings .	15,000 or more	n-1	100%	Maintain 100% GPD less 12MVA. Remaining 12MVA restored within 3 hours.	Repair time.
C	Between 12 and 25 MVA ie. small GXP, primary CBD & urban substations	7,000 to 15,000	n-1	100%	Maintain 100% of GPD.	Restore 90% of GPD within 3 hours and remaining 10% in time to repair.
B1	Between 6 and 12 MVA ie. Primary urban or industrial substations.	3,500 to 7,000	n	100%	Restore 75% of GPD within 15 min, restore 90% within 3 hours, and remaining 10% in time to repair.	Within 3 hrs restore 90%, repair time 100%
B2	Between 3 and 6 MVA ie. single transf subs and urban meshed feeders	1,750 to 3,500	n	80%	Restore 75% of GPD within 30 minutes, 90% within 3 hours and remaining 10% in time to repair.	Restore 100% in time to repair.
B3	Between 1 and 3 MVA ie. rural zone substation, meshed feeders.	500 to 1,750	n	67%	Restore 50% of GPD within 1 hour, 90% within 3 hours, and remaining 10% in time to repair.	Restore 100% in time to repair.
A	Less than 1MVA ie. rural feeders, urban spurs, distribution transformers	Less than 500	n	Note 1	Restore 100% in time to repair.	Restore 100% in time to repair.

Note 1 - refer to ENL's Customer Service Standards for LV Network backup, dual distribution transformer capacity or temporary supply criteria. Temporary options include construction of prefabricated OH lines, HV or LV flexible surface jumpers or 300kVA generator supplies.

The following table confirms that ENL's target security levels are being met at zone substation level, for the forecast loads over the planning period...

Sub.	Applicable security level	Projected 2021/22 load	Additional provision for security
Carnarvon	C	Load well within 11kV back-feeding capacity from Parkinson & Port.	None required
JNL	B1	Load within 11kV support capacity from adjacent Matawhero and Parkinson Substations.	None required
Kaiti	C	Load within 11kV support capacity from adjacent Port Substation.	Possibility that in the long term not all Kaiti load could be back-fed on the 11kV from Port. Single transformer is a recognised point of weakness.
Makaraka	B1	Expected load not expected to exceed transformer capacity	In Medium term opportunities to provide additional support capacity from Matawhero/JNL are a consideration.
Matawhero	C	Expected load well within capacity	None required
Ngatapa	B3	Expected load well within capacity	None required
Parkinson	C	Expected load well within capacity	None required
Patutahi	B1	Expected load well within capacity of either transformer.	None required.
Pehiri	B3	Expected load well within capacity	None required.
Port	C	Expected load well within capacity	None required.
Puha	B2	Expected load within capacity but only 1 transformer	Security provisions will be required potentially from Ngatapa
Ruatoria	B3	Expected load well within capacity of diesel generator and 11kV back-feeding capability.	None required.
Te Araroa	B3	Expected load could be totally supplied by diesel generator.	None required.
Tokomaru	B3	Expected load well within capacity of diesel generator and 11kV back-feeding capability.	None required.
Tolaga	B3	Expected load well within capacity of diesel generator	None required.

		and 11kV back-feeding capability.	
Blacks Pad	B3	New substation planned	Sub-transmission development
Kiwi	B2	Expected load will require reconfiguration	Upgrade feeder assets
Tahaenui	B3	Expected load well within capacity	None required
Waihi	B2	Expected load within capacity	None required
Tuai	A	Expected load will never merit any alternative supply other than the possibility of re-locating a diesel generator if an outage looked prolonged.	None required.

#### **4.2.2.5 Guiding ENL’s security policy**

The following philosophies are fundamental to meeting ENL’s security standards in the design of any network component...

- ENL’s network is a low density, lightly loaded, distribution network. In a network of this character the provision of security via full redundancy can rarely be justified, is not cost efficient, and does not offer the best fault tolerance.
- Having said that, the preferred method of providing contingency supply will be via excess capacity in adjacent network components.
- Transformer loading for both zone and distribution transformers shall comply with IEC 354 which permits short duration overloads beyond nominal ratings under specified ambient and cyclical conditions.
- Alternative supply options will be built at the lowest voltage practical due to better inherent fault tolerance and flexibility with respect to interconnection.
- Cables will not be loaded into duty cycle levels of loading. Legacy jointing practices and installation design do not provide for this mode of operation.

- Preference will be given to ring design for an alternative route instead of double spur circuits.
- In rural spur networks the density of isolation points will be used to localize the effects of faults, to achieve customer service standards.

#### **4.2.2.6 Specific security provisions**

##### **Transmission and Sub-transmission**

- (n-1) security will be provided for all lines, cables, and equipment where loading exceeds 12MVA.
- Breakers' will be rated at 2x expected max demand to enable carrying of adjacent feeder loads.
- 33kV and 50kV CB's shall only be fitted with bypassing arrangements when supplying a spur line. This is to allow maintenance or repairs with the substation(s) on-line.

##### **Zone Substations**

- Transformer loading is to comply with IEC354. This permits overloading beyond nominal ratings under specified ambient and cyclical conditions. Thus the duration of restoration following a first interruption will result in no ageing beyond design provisions. Overloading of transformers such that ageing occurs will only be permitted for a second contingent event of up to 1 hour.
- Loading shall never exceed 120% of the transformers design rating or the lesser of limits imposed by cabling.
- All connections and auxiliary equipment shall be rated for continuous operation at maximum load levels.
- Zone transformers will be rated to support a minimum of half the loading of neighbouring zones.
- Installation of forced or assisted cooling will be used in preference to dual transformer installations or capacity upgrades where overload is required beyond IEC354 for contingent events.

- Zone substations carrying normal load in excess of 12MVA will be of dual transformer designs if it is unlikely that neighboring substations or feeder circuits will be able to support that substation after allowing for 10 years growth.
- 11kV switch panels will have a split bus arrangement where maximum demand is likely to exceed 6MVA. In single transformer substations the incomer and the tie line to the adjacent substation shall be connected on opposite sides of the bus-tie. This ensures that at least one side of the 11kV bus can be energised.
- Urban 11kV feeder CB's shall not be normally loaded beyond 4MVA to allow sufficient capacity to pick up 2MVA from an adjacent feeder. The tie feeder between Carnarvon St and the Port area requires an 8MVA rating.
- Feeder cables from CB's must be rated to match CB excess capacity requirements which will typically be 6MVA in the urban, CBD or industrial area. In rural areas feeder cables shall be rated to 3MVA.
- All feeder circuits must have a tie switch external to the substation to another circuit from the opposite side of the bus or ties to a feeder from an adjacent substation.

### **Distribution**

- 11kV circuits provide security via excess capacity, interconnection and isolation ability i.e. the focus is on restoration speed and contingency provision as opposed to un-interruptible supply. Generally excess capacity and provision of mobile generation provide LV circuit security. In key commercial and industrial areas LV interconnection may be appropriate. Generally the installation of remote or automatically operated equipment shall be governed by the response times determined in section 4.2.2.4.
- 11kV pad mounted switchgear provisions...
  - No more than 3 transformers supplied from 1 switchboard without bus section.
  - Not more than 1MVA fed from switchgear supplied from a single cable circuit (excluding industrial situations).

- No more than 1MVA of installed transformers and associated switchgear cascaded with no back feed.
- Not more than 1 cable circuit connected directly to the bus of a switchboard arrangement.
- In rural areas an air break switch will be installed to provide an isolation point every 50 customers or 25km of downstream circuit.
- Cables will be designed with 33% excess capacity to enable sharing of half the load of the connecting circuit where there are two alternative supply routes.
- Where overhead lines have back-feed capability they will be permitted to operate to 120% capacity in emergencies. Therefore they will be designed for sag and clearances appropriate to the maximum conductor operating temperature rather than 50<sup>0</sup>C provided this does not exceed 75<sup>0</sup>C.
- Lines will not be permitted to have more than 2% losses at installation.
- Spur assets (lines, cables, transformers) that cannot be supported via the LV network will have provisions for quick connect standby generation if normal loading exceeds 200kVA.
- Distribution transformers (less than 1,000kVA) will be permitted to overload to the ratings of IEC354.
- In commercial and industrial areas...
  - General distribution transformers will normally be 500kVA units. All cables shall be rated to allow loading of the transformer to 120%. This would provide overload capacity for 6 hours in winter peak areas at 20<sup>0</sup>C (10 hours at 10<sup>0</sup>C) and for 3 hours in summer peak areas at 30<sup>0</sup>C given an initial loading at 80%. Actual load profiles for a given transformer where initial loading is less than 80% will enable extension to the period of overload.
  - LV interconnection shall normally be specified to allow for an out of service condition of an intermediate transformer. Where LV-interconnected, transformers should not exceed



(other than for short duration's of less than 1 hour) 80% of their rating under normal operating conditions.

- LV runs from transformer to an open tie point should not exceed 200m (400m from transformer to transformer).
- Loads in industrial areas greater than 50kVA should have a dedicated LV feed.
- In urban domestic supply areas including small commercial areas located predominantly within an urban area...
  - Transformer size should be standardised to 200kVA in winter peak areas with cables rated to allow loading of the transformer to 133% and to 300kVA in summer peak areas with cables rated to allow loading of the transformer to 100%.
  - Each LV feeder should not be supporting more than 25 domestic supplies assuming an ADMD of 3kVA.
  - LV interconnection would normally only be provided where a small commercial shopping center is located within a predominately urban area. 300kVA transformers may be required.
  - Provision of quick mobile substation connections to the LV is preferred to the provision of LV interconnection.
- Transformers must be able to be isolated from LV bus bars via incomer links where LV interconnection to another transformer is provided.

### **4.2.3 Development Funding**

There are a number of options available to ensure ENL is able to fund and resource development projects. Typically new load and network extension projects are funded by the requesting company or developer who has the option of selecting local or national resources to establish the required assets. This arrangement usually applies to projects in categories 3 and 4 above and in some cases to category 2 hence the likelihood that ENL will be faced with insufficient funding or resources to achieve projects in category 1 is very low. Should the rate of

development ever increase beyond ENL's capabilities then deferral of new load is a final option.

#### **4.2.4 Choosing the option**

The level of analysis is guided by the bottom row of Table 4.1.2(a). In particular, the underlying principles will be reused for sufficiently similar circumstances, whilst for new situations previous principles with suitable modifications are applied.

Broadly the cheapest option that meets minimum consumer needs, safety and environmental standards and revenue constraints will be chosen and modified to suit particular circumstances such as likely future load growth. The asset management risk assessment tool (refer 6.2.3) is used to determine the relative priority of both development options and renewal plans in terms of activity category and identified projects.

### **4.3 Demand forecast**

#### **4.3.1 Current demand**

##### **4.3.1.1 Gisborne Region**

ENL's current after diversity maximum demand (ADMD) at Massey Rd GXP for the 2010/2011 financial year was 43.422MW, This demand is disaggregated in Figure 4.3.1.1(a).

Figure 4.3.1.1a - Gisborne GXP Maximum Demand

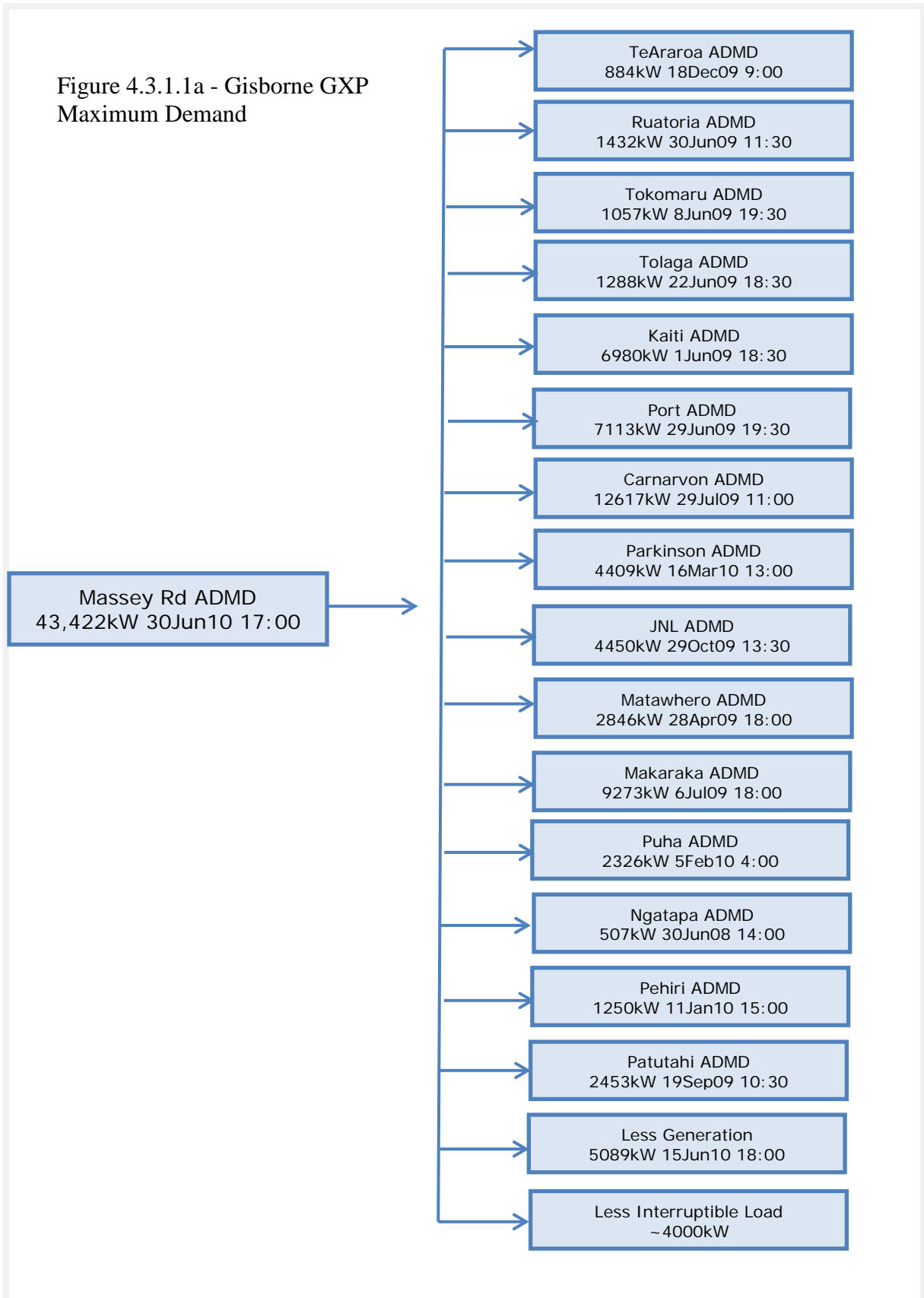

**4.3.1.2 Wairoa**

ENL’s current after diversity maximum demand (ADMD) at Wairoa GXP for the 2010/2011 financial year was 8.546MW and for the Tuai GXP 0.626MW, which is disaggregated in Figure 4.3.1.2(a).

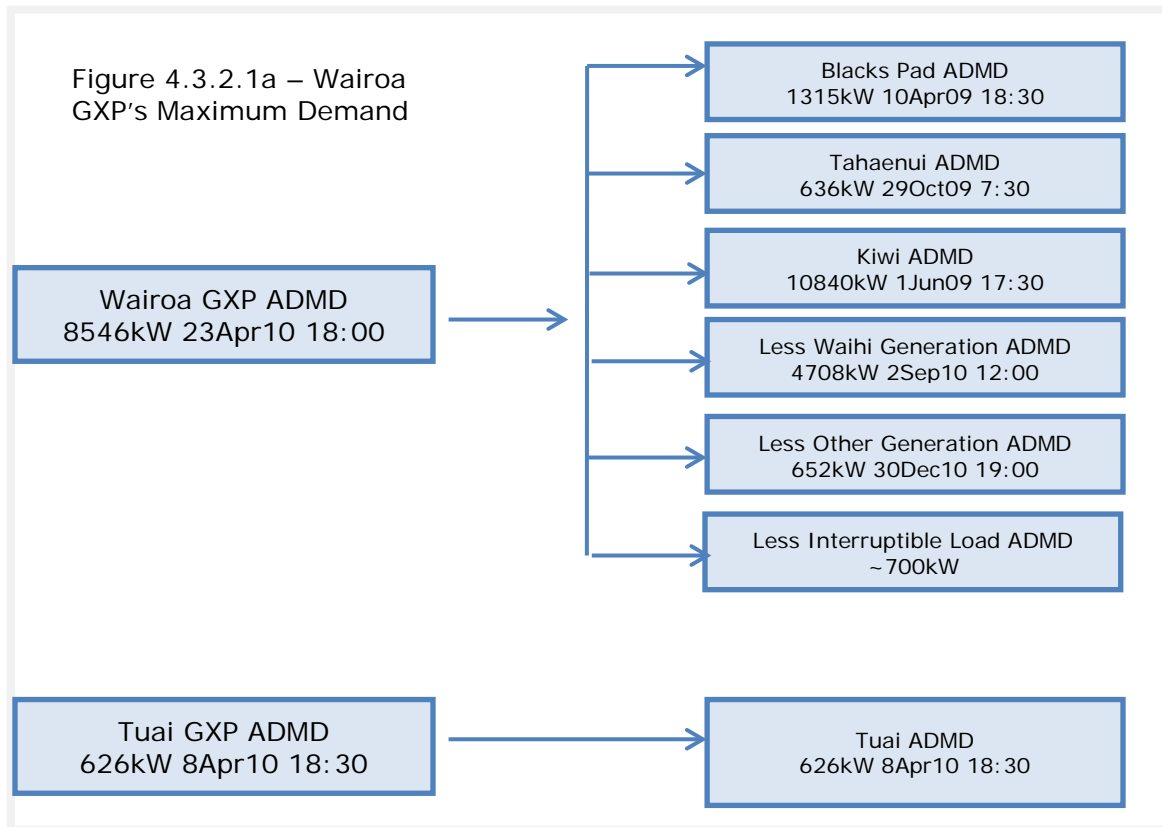

**4.3.1.3 Demand Management Initiatives**

The system demand figures including embedded generation are-

Gisborne Region	46.865MW	15 Jun 2010 18:00
Wairoa Region	10.376MW	1 Jun 2010 9:00
System Total	56.404MW	15 Jun 2010 18:00

Demand management initiatives that have had a measurable impact on the Gisborne and Wairoa GXP are the use of embedded generation and the Load control plant.

- Use of distributed generation has reduced the peak demand by 5MW and 3MW at the Gisborne and Wairoa GXP's respectively. Given the installed capacity of generation totals 13MW this indicates less than 65% of the generation potential was able to be realised.
- Use of load control to manage demand is likely to have contributed around 2MW of reduction to the total peak demand. As metering equipment is not setup to measure the demand that wasn't supplied the measurement of load control demand effectiveness can only be determined by extrapolation of the daily demand profile curves (refer section 4.7.1.3) over the flat area for times where load control was active.

Demand management initiatives that do not have a measurable impact are generally undertaken by customers with external Energy consultants providing the technical expertise. As ENL wishes to encourage any initiatives no notification barriers are imposed on the activities. Hence ENL is often not advised of activities been undertaken. Examples of two initiatives ENL is aware of are...

- Replacement of the compressor drives with variable speed drives on Eastland Groups cool store. This initiative produced only a slight demand reduction but the reduction in energy usage was of the order of 20%.
- Solar hot water cylinder upgrades at TePuia Springs. This project was linked to a government initiative and involved the installation of a solar hot water system with traditional element backup. While there was a resulting reduction in energy usage there was an increase in demand as the original hot water cylinders with 1kW elements were replaced with cylinders containing 3kW backup elements. As the backup elements are typically needed at times coincident with the maximum demand the expectation of reduced demand was not realised.

As the following forecasts provided in this section rely heavily on historical trends and involve a high degree of aggregation, minimum and maximum demand forecasts are provided which take into account any demand reduction initiatives that may occur.

As discussed in the development section 4.7.1.4 there is a limit to the extent that demand initiatives can be effective which occurs when the demand profile flattens.

Future demand initiatives targeting a shift in consumption from day to the period between 12:00am and 4:00am at night will have the

biggest impact on demand. Currently no initiatives to achieve this have been identified.

#### **4.3.1.4 Demand Management Impact on Forecasts**

As described in 4.3.1.3 above measurable Impacts on demand initiatives to date equate to approximately 10% of the GXP peak demands. This has effectively enabled ENL to defer traditional defer traditional asset solutions by up to 5 years. This is reflected in the deferral of bulk supply and Subtransmission options described in section 4.4.

#### **4.3.2 Drivers of future demand**

Key drivers of demand growth (and contraction) are depicted in Figure 4.3.2(a) below.

Figure 4.3.2(a) – Drivers of demand

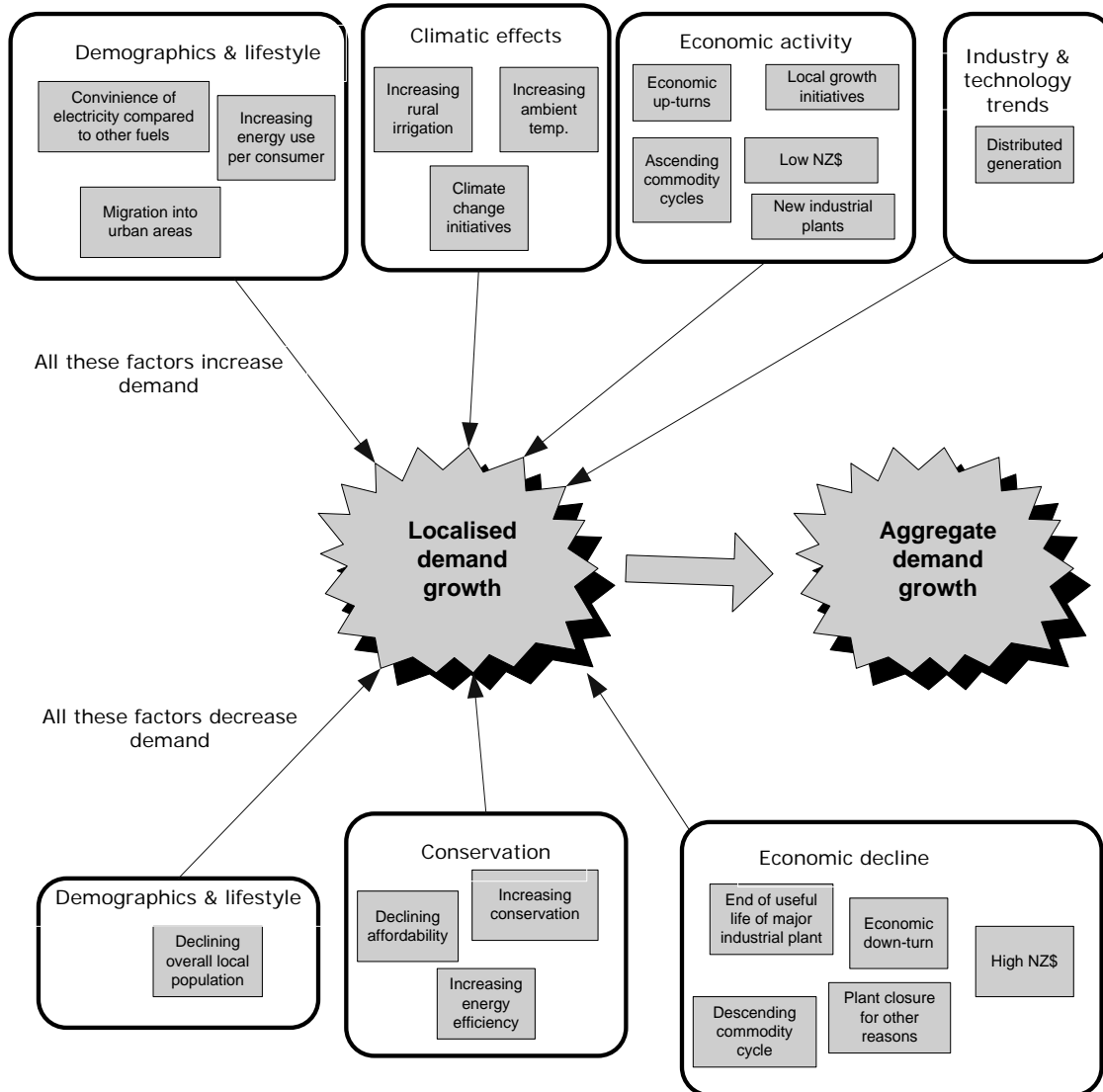

At a localised level (11kV feeder) one or two of these issues will generally predominate, will be predictable and manageable, and can be aggregated into a reasonably reliable feeder demand forecast. The estimates of future demand are described in section 4.3.3 below.

The following section examines in detail what ENL believes will be the most significant drivers of its network capacity and configuration over the next 15 to 20 years...

**4.3.2.1 Maturing forestry**

**Expected processing volumes**

A very large increase in forest harvesting is predicted for the East Coast area. The Ministry of Agriculture and Forestry's *National Exotic Forest Description 2000* provides forecasts of the total recoverable volume of logs through to 2040. Current log volumes are expected to approximately triple to around 2.5 million m<sup>3</sup> within 5 years, and increase still further to around 3.5 million m<sup>3</sup> approximately 10 years after that.

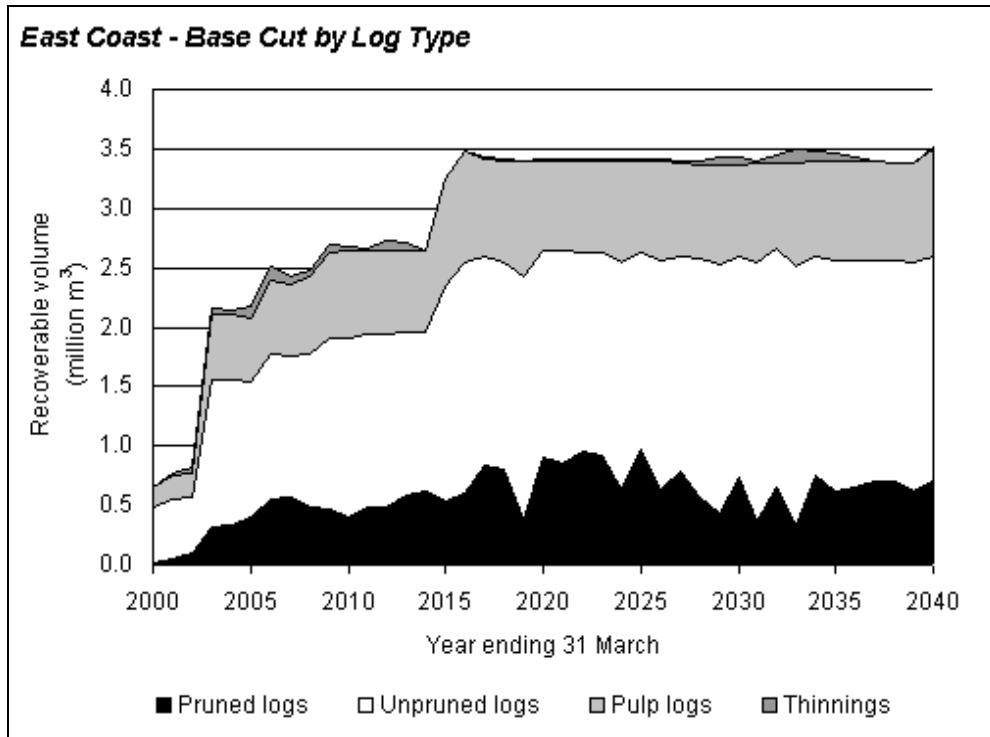

Source - National Exotic Forest Description: National and Regional Wood Supply Forecasts 2000

**Likely distribution requirements**

The existing JNL mill can be expanded to accommodate approximately 36% additional throughput but beyond that additional harvest volumes will require additional mills. On the assumption that the ratio of raw log exports to the total harvest volume remains approximately the same further mills may be required, A large mill would probably have a combined heat & power (“CHP”) unit fuelled primarily by waste wood and boosted by gas to deliver the larger part of its gross energy requirements.

The electricity load requirements associated with new plants in close proximity are likely to be between 7 to 10 MW if they are similar to the existing JNL mill. The network around Matawhero where processing



plants are most likely to locate will therefore need to supply an additional 10 MW.

Representatives of the timber industry lead ENL to believe that mill development and expansion plans are in progress but no completion dates are available.

### **Likely sub-transmission requirements**

Impacts on the sub-transmission network would of course be greater and reflect the aggregated regional load increase, perhaps in the order of 25 to 30MW by 2020. This additional demand could be minimised through embedded CHP plants exporting surplus power to the distribution network.

### **Knock-on community economic growth**

The Tarawhiti Development Taskforce report estimates that forest harvesting and processing could ultimately over time generate 15,000 – 20,000 additional jobs in the region. Additional connections and community prosperity would be almost certain to drive increased domestic consumption.

### **Possible investment risks**

On a final note, the regional benefits and anticipated increases in load will be limited if most logs are exported unprocessed, and this constitutes a real investment risk to ENL given that historically the New Zealand forestry sector has exported raw logs.

#### **4.3.2.2 Regional natural gas reserves**

Undeveloped gas resources existing in the region could be a source of relatively cheap electricity generation in the Gisborne and Wairoa regions and radically alter net power flows. New gas-fired generation could also significantly reduce net power imports at Massey Rd. Given the high costs of augmenting the double circuit 110kV line supplying Massey Rd or the Vector high-pressure gas main from Opotiki, local gas supplying local generation could provide cheap and stably-priced electricity.

Current issues associated with the development of gas-fired generation is difficulties associated in securing price surety for long term gas supply and current EIRA restrictions on distribution company involvement in generation and retailing.

#### **4.3.2.3 Changes In Technology**

Advances in generation technology that replace the need for network capacity are already emerging and will almost certainly be a commercial reality by 2017. The need for investment in network assets with an economic 40 year life (but a practical life of about 70 years) is therefore clearly subject to challenge. This is particularly true of capacity investment in the remote rural network, where small scale distributed generation is potentially more economical.

Transmission and distribution lines exist for the sole purpose of transporting electricity from where it is generated to where loads are located. Logically, if generation could be moved closer to loads, then there would be less need for transmission and distribution. In this sense, new generation “competes” with electricity lines businesses/investments. This is particularly true of distributed generation (and direct substitutes such as direct solar water heating). Larger embedded generation plants are less of a threat for distribution networks, but pose a significant risk of bypass for transmission networks. These technologies can also be used as substitutes for network upgrades.

Potential new generation around Gisborne includes new biomass generation to accompany additional forestry mills, larger biomass plant(s) that would produce more power than required by the mills, gas generation plant to take advantage of surplus capacity in the Vector pipeline or new gas discoveries, small gas turbines and hydro that could be operated as peaking plant to reduce peak demand, and other renewables such as the high wind and solar resources in the region.

ENL may have the opportunity to use embedded and distributed generation to reduce the need for transmission and distribution upgrades, and can also re-engineer its network during the current upgrade program so that it is more suitable for a distributed generation environment. These issues are the subjects of a development strategy in preparation to minimise investment risk and lower electricity supply costs.

Conversely where the scale of any distributed generation is greater than the local load the generation surplus at any location may require line upgrades and/or distribution or transmission solutions in addition to the existing lines. While this would not result in a reduction in the

local region long term benefits remain at the transmission or national level.

Introduction of smart metering systems by some Energy Retailers active in the region is progressing. The impact of this technology is currently too small to identify the effects on energy and demand measurements.

While smart meters are expected to reduce energy and demand, any benefit will require end users to change their behaviour patterns before any change will occur. This is particularly true for the domestic market.

### **4.3.3 Estimated zone sub demands**

As outlined in detail in the remainder of section 4, ENL expects its future demand to vary from the current demand as follows...

- A moderate rate of growth within the existing network footprint in the Kaiti / Port area, the Gisborne industrial estate and the Mahia Peninsula.
- A very high rate of growth within or very close to the existing network footprint at Matawhero if the impending forest harvest is processed locally.
- A low rate of growth along the east coast north of Gisborne.
- Possible contraction of demand in the rural parts of the Wairoa District other than Mahia.

ENL's collective experience strongly indicates that it would be rare to ever get more than a few months confirmation (sufficient to justify significant investment) of definite changes in an existing or new major consumers demand. This is because most of these consumers operate in fast-moving consumer markets and often make capital investment decisions quickly themselves, and they generally keep such decisions confidential until the latest possible moment. Probably the best that ENL can do is to identify in advance where the network has sufficient surplus capacity to supply a large chunk of load, but as experience shows industrial location decisions rarely if ever consider the location of energy supply – they tend to be driven more by land-use restrictions, raw material supply and transport infrastructure.

This section examines each of ENL's zone substations at a feeder level in regard to the issues identified above and provides a 10 year projection of demand, determined using ENL's collective experience, for each sub and what provision for growth if any is required.

### 4.3.3.1 Gisborne Region

#### Carnarvon St

Feeder	Rate & nature of growth	Provision for growth
Aberdeen	Typical domestic commercial mix Medium	None required
Anzac	Typical domestic commercial mix Medium	None required
Awapuni	Typical domestic commercial mix Medium	None required
Childers	Typical domestic commercial mix Medium	None required other than for security
City	Swings in growth due to cyclic prosperity in CBD	None required other than for security
Gladstone	Typical domestic commercial mix Medium	None required other than for security
Kahutia	Swings in growth due to cyclic prosperity in CBD	None required
Palmerston	Typical domestic commercial mix Medium	None required other than for security
Watties	Commercial subject to lumpy change	None required
Sub	High, less lumpy than industrial subs but still dependent on retail cycles. Likely to exhibit load shifts between feeders.	None required – projected 10 year load is expected to be only 65% of capacity.

#### JNL

Feeder	Rate & nature of growth	Provision for growth
JNL	Large step changes Moderate	Non required
Matawhero Tie	Provides for security only	Non required
Sub	Moderate	Non required

#### Kaiti

Feeder	Rate & nature of growth	Provision for growth
Dalton	Domestic Medium	Non required
Delatour	Domestic load increases rather than new load	Non required
Hershell	Domestic Medium	Non required

Tamarau	Domestic Medium	Non required
Wainui	Domestic Medium	Non required
Whangara	Domestic Rural Low to Medium	Growth constrained intermediate zone sub considered
Sub	Moderate, reasonably diverse and predictable as this is largely domestic.	Projected 10 year load is expected to be about 95% of capacity, Expect to off-load 3MW or 4MW to Port. If large growth in Wainui possibly establish Whangara substn (2.5MVA), 2013 -15.

## Makaraka

Feeder	Rate & nature of growth	Provision for growth
Bushmere	Lifestyle Rural medium	None required
Campion	Lifestyle domestic High	None required
Haisman	Lifestyle domestic High	None required
Nelson	Lifestyle domestic High	None required
Sub	High	Projected 10 year load just exceeds 100% of capacity. Off-loading 2MW or 3MW to Patutahi is an option. If high subdivision growth in Linton West/Nelson Rd possibly establish Mangapapa substn (12.5MVA) 2017 -2020.

## Matawhero

Feeder	Rate & nature of growth	Provision for growth
Bell	Industrial Rural medium	None required
Dunstan	Industrial Rural medium	None required
JNL A	Security Tie	None planned
Manutuke	Industrial load new load forecast	None required
Waipoa	Industrial load new load forecast	None required
Sub	Very high	Projected 10 year load is expected to be 85% of capacity. Offset by and secures JNL sub.

## Ngatapa

Feeder	Rate & nature of growth	Provision for growth
Ngatapa	Rural minimal	None required
Tahora	Rural minimal	None required
Totangi	Rural minimal	None required
Sub	Low, vulnerable to single large load being a high percent of existing surplus capacity.	Security Provision planned – projected 10 year load is expected to be only 60% of capacity under existing normal conditions

## Parkinson

Feeder	Rate & nature of growth	Provision for growth
Cedenco	Industrial Low	None required
Chalmers	Domestic Low	None required
Elgin	Domestic Low	None required
Innes	Industrial Steady but Lumpy increases	None required
Lytton	Domestic Low	None required
Solandis	Domestic Low	None required
Willows	Security Tie Low	None required
Sub	Low, potentially lumpy and uncertain due to medium sized industrial loads.	None required – projected 10 year load is expected to only be 65% of capacity.

## Patutahi

Feeder	Rate & nature of growth	Provision for growth
Lavenham	Rural Mix Low	None required
Muriwai	Rural Mix Low	None required
Te Ari	Rural Mix Low with large load	No needs identified
Waimata	Rural Mix Low	None required
Sub	Low.	None required – projected 10 year load is expected to be only 33% of capacity. Could take about 3MW of load from Makaraka and Matawhero if necessary.

## Pehiri

Feeder	Rate & nature of growth	Provision for growth
Parikania	Rural Mix Low	None required
Tahunga	Rural minimal Rural Mix Low	None required
Tiniroto	Rural Mix Low	None required
Warenga	Rural minimal	None required
Sub	Low.	None required – projected 10 year load is expected to be only 30% of capacity.

## Port

Feeder	Rate & nature of growth	Provision for growth
Crawford	Domestic Low	None required
Esplanade	Commercaill load new load forecast	None required
Harris	Domestic Low	None required
Port	Industrial load Low	None required
Sub	Low.	None required – projected 10 year load is expected to be only 15% of capacity, so

		there is scope to shift about 9MW on to Port from Kaiti or Carnarvon.
--	--	---

## Puha

Feeder	Rate & nature of growth	Provision for growth
Kanikania	Rural growth generally low. Small increases significant in terms of total load one significant load at end of line.	None Required
Matawai	Stable Township no growth	None Required
Te Karaka	Stable township possible decrease offset by outlying lifestyle blocks	None Required
Whatatutu	Rural growth generally low. Small increases significant in terms of total load	None Required
Sub	Low. Large step increase in load experienced in 2009 due to addition of distributed generation with var requirement.	None required – projected 10 year load is expected to be only 45% of capacity.

## Ruatoria

Feeder	Rate & nature of growth	Provision for growth
Makariaka	Rural growth generally low. Small increases significant in terms of total load	None Required However security support limited.
Ruatoria	Stable Township. Growing slowly	None Required
Tikitiki	Rural growth generally low. Small increases significant in terms of total load	None Required
Sub	Low.	None required – projected 10 year load is expected to be only 33% of capacity.

## Te Araroa

Feeder	Rate & nature of growth	Provision for growth
Awatere	Rural growth generally low. Small increases significant in terms of total load	None Required
Hicks	Rural growth generally low. Small increases significant in terms of total load	None Required
Te Araroa	Stable Township	None Required
Sub	Low, vulnerable to single large load being a high percent of existing surplus capacity.	None required – projected 10 year load is expected to be only 35% of capacity.

## Tokomaru Bay

Feeder	Rate & nature of growth	Provision for growth
Inland	Rural growth generally low. Small increases significant in terms of total load	None Required however security support necessary.
Mata	Rural growth generally low. Small increases significant in terms of total load	None Required however security support necessary.
Seaside	Rural growth generally low. Small increases significant in terms of total load	None Required
Sub	Low, vulnerable to single large load being a high percent of existing surplus capacity.	None required – projected 10 year load is expected to be only 45% of capacity.

## Tolaga Bay

Feeder	Rate & nature of growth	Provision for growth
Rototahi	Rural growth generally low. Small increases significant in terms of total load	None Required
Tauwhare	Rural growth generally low. Small increases significant in terms of total load	None Required
Tokitie	Rural growth generally low. Small increases significant in terms of total load	None Required however security support necessary.
Town		
Sub	Low.	None required – projected 10 year load is expected to be only 37% of capacity.

## 4.3.3.2 Wairoa Reigon

### Blacks Pad

Feeder	Rate & nature of growth	Provision for growth
Sub and feeder	High, spread amongst life-style blocks, holiday homes and dairy conversions. Holiday homes add a peaky aspect to the load which makes recovery of investment awkward.	Already using one 1MWe diesel generator to support both load and voltage. First step to provide additional network capacity has been to move Blacks Pad closer to the Mahia load, next step will be install a larger 33/11kV transformer.

### Kiwi

Feeder	Rate & nature of growth	Provision for growth
AFFCO	Unpredictable	At limit
Borough 1	Low Growth Township	Approaching secure limit



Borough 2	Low Growth Township with industry	Approaching secure limit
Brickworks	Little if any	Voltage constrained at far end, so any remote growth would require either re-conductoring or adopting of 22kV.
Kiwi A	Incomer	At capacity 33kV upgrade necessary
Kiwi B	Incomer	At capacity 33kV upgrade necessary
Kiwi C	Incomer	At capacity 33kV upgrade necessary
Nuhaka	Little if any	Voltage constrained at far end, so any remote growth would require either re-conductoring or adopting of 22kV.
Waihi	Generator - no increase expected	None Required
Sub	Likely growth is almost totally big industrial and therefore lumpy and difficult to forecast.	Transformer required in future

## Tahaenui

Feeder	Rate & nature of growth	Provision for growth
Sub and feeder	Minimal if any growth. Load can peak if used to back feed Blacks Pad or the Nuhaka feeder.	None required

## Tuai GXP

Feeder	Rate & nature of growth	Provision for growth
Lake	Little if any	None required
Ruatikuri	Little if any	Distance main issue Voltage regulator or capacitors beyond current planning period
Sub	Minimal if any.	Non required. Option of relinquishing Transpower supply and taking supply from the Tuai generation bus does not present any growth constraints.

## Waihi

Feeder	Rate & nature of growth	Provision for growth
Sub	Nil – takes injected generation from Waihi hydro.	None required.

## 4.3.4 Estimated demand aggregated to GXP level

### 4.3.4.1 Gisborne Region

Sub.	Rate & nature of growth	Provision for growth
Carnarvon	Low, less lumpy than industrial subs but still dependent on retail cycles. Likely to exhibit load shifts between feeders.	None required – projected 10 year load is expected to be only 65% of capacity.

JNL		
Kaiti	Low, reasonably diverse and predictable as this is largely domestic.	Projected 10 year load is expected to be about 95% of capacity, so expect to off-load 3MW or 4MW to Port.
Makaraka	Low	Projected 10 year load just exceeds 100% of capacity. Off-loading 3MW or 4MW to Patutahi would be a key option.
Matawhero	Low	Projected 10 year load is expected to be 85% of capacity. JNL new sub
Ngatapa	Low, vulnerable to single large load being a high percent of existing surplus capacity.	None required – projected 10 year load is expected to be only 60% of capacity.
Parkinson	Low, potentially lumpy and uncertain due to medium sized industrial loads.	None required – projected 10 year load is expected to only be 65% of capacity.
Patutahi	Low.	None required – projected 10 year load is expected to be only 33% of capacity. Could take about 6MW of load from Makaraka and Matawhero if necessary.
Pehiri	Low.	None required – projected 10 year load is expected to be only 30% of capacity.
Port	Low.	None required – projected 10 year load is expected to be only 15% of capacity, so there is scope to shift about 9MW on to Port from Kaiti or Carnarvon.
Puha	Low.	None required – projected 10 year load is expected to be only 45% of capacity.
Ruatoria	Low.	None required – projected 10 year load is expected to be only 33% of capacity.
Te Araroa	Low, vulnerable to single large load being a high percent of existing surplus capacity.	None required – projected 10 year load is expected to be only 35% of capacity.
Tokomaru	Low, vulnerable to single large load being a high percent of existing surplus capacity.	None required – projected 10 year load is expected to be only 45% of capacity.
Tolaga	Low.	None required – projected 10 year load is expected to be only 37% of capacity.
GXP	Low	Need another 110kV circuit from Tuai to provide (n-1) security at current demand, and will require a second additional 110kV circuit to meet demand growth. Would be useful to build a new GXP near Matawhero or Makaraka instead of terminating any new lines at Massey Rd.

#### **4.3.4.2 Wairoa Region**

<b>Sub.</b>	<b>Rate &amp; nature of growth</b>	<b>Provision for growth</b>
Blacks Pad	Low at limit, spread amongst life-style blocks, holiday homes and dairy conversions. Holiday homes add a peaky aspect to the load which makes recovery of investment awkward.	Already using one 1MWe diesel generator to support both load and voltage. First step to provide additional network capacity has been to move Blacks Pad closer to the Mahia load, next step will be install a larger 33/11kV transformer.
Kiwi	Likely growth is almost totally big industrial and therefore lumpy and difficult to forecast.	Additional growth complication is that the Nuhaka - Frasertown and Brickworks - Raupunga feeders are very long (and hence voltage constrained) so any significant load growth on either of these feeders would require 11kV reinforcement as well as augmenting Kiwi.
Tahaenui	Minimal if any growth. Load can peak if used to back-feed Blacks Pad or the Nuhaka feeder.	Non required.
Waihi	Nil – takes injected generation from Waihi hydro.	None required.
Wairoa GXP	Likely growth is almost totally big industrial and therefore lumpy and difficult to forecast.	Will ultimately require upgrade to 110/33kV
Tuai GXP	Minimal if any.	Non required. Option of relinquishing Transpower supply and taking supply from the Tuai generation bus does not present any growth constraints.

#### **4.3.4.2 Zone Substation Growth**

Zone substation capacities and present loads are shown in the following table. The loads shown are half hour maximum demands with normal load control policy in effect. Reductions at some sites compared with previous years are caused by imbedded generation reducing the burden on the Zone substation Transformer assets. As the expected life of the generation assets is shorter than that of the Transformer assets and the reliability/availability is lower the capacity of the transformers is set to provide for peak demands should the generators be unavailable.

Forecast peak power demands for the installed transformer capacity by the end of the planning period are also indicated.

Growth forecasts have been averaged on a 10-year prediction to smooth out step increments introduced by new loads.

A year by year forecast has not been provided as the exact timing and nature of future loads in is not known hence the information would be inaccurate and misrepresent the general predictions provided.

Substation	Transformer Capacity (MVA)	Maximum 2010/11 (MW)	%of Installed Capacity	Growth (%)	Load 2023 (MW)	%of Installed Capacity
TE ARAROA	1 x 2.5	1.019	41%	0%	0.98	39%
RUATORIA (5/7MVA)	1 x 5.0/7.5	1.519	30%	1%	1.59	32%
TOKOMARU	1 x 2.5	1	40%	1%	1.18	47%
TOLAGA	1 x 5.0	1.461	29%	0%	1.42	28%
KAITI	1 x 12.5	7.778	62%	0%	7.71	62%
PORT	1 x 12.5	7.173	57%	0%	7.86	63%
CARNARVON	1 x 12.5, 1 x 12.75	12.715	51%	0%	13.94	56%
PARKINSON	2 x 12.5	4.603	18%	0%	4.87	19%
MAKARAKA	1 x 12.75	9.24	72%	1%	10.35	81%
PATUTAHI	2 x 5.0	2.4	24%	0%	2.71	27%
PEHIRI	1 x 2.5	1.442	58%	1%	1.39	56%
NGATAPA	1 x 2.5	0.488	20%	0%	0.56	22%
PUHA	1 x 5.0	2.384	48%	4%	2.67	53%
JNL	1 x 12.75	4.7	37%	0%	4.92	39%
MATAWHERO (5/7MVA)	2 x 5.0/7.5	5.461	36%	0%	3.14	21%
TUAI		0.626		0%		
KIWI		10.5		0%		
BLACKS PAD	1 x 1.5 (33/11)	1.217	81%	5%	1.53	102%
TAHAENUI	1 x 1.5 (33/11)	0.553	37%	5%	0.74	49%

### 4.3.5 Overall System Growth

By projecting growth trends forward, coincident system peak demand has been forecast to grow from 56 MW in 2010/11 to a worst case of 93 MW in 2022. This gives an overall growth rate of approximately 1.8% p.a.

Alternatively the conservative scenario indicates minimal growth to 61 MW in 2022 which equates to a rate of 0.25% p.a.

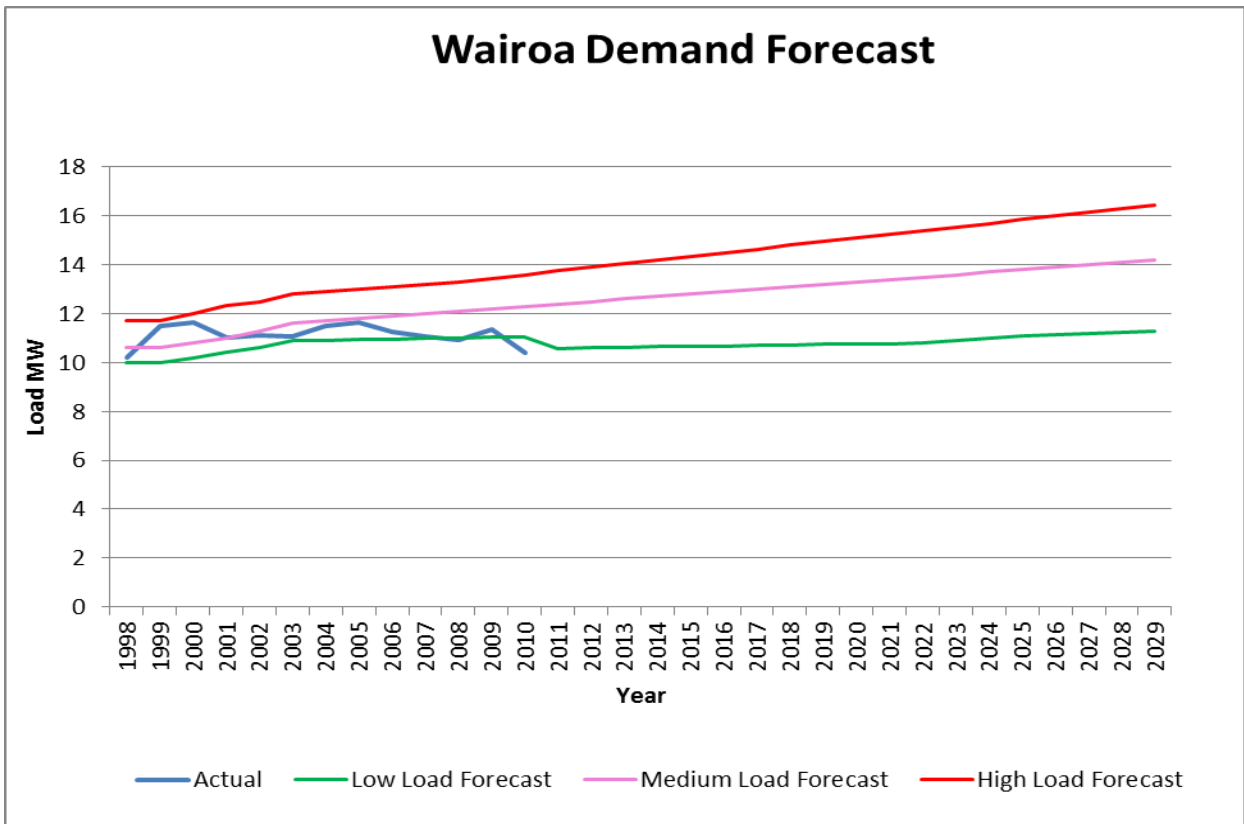
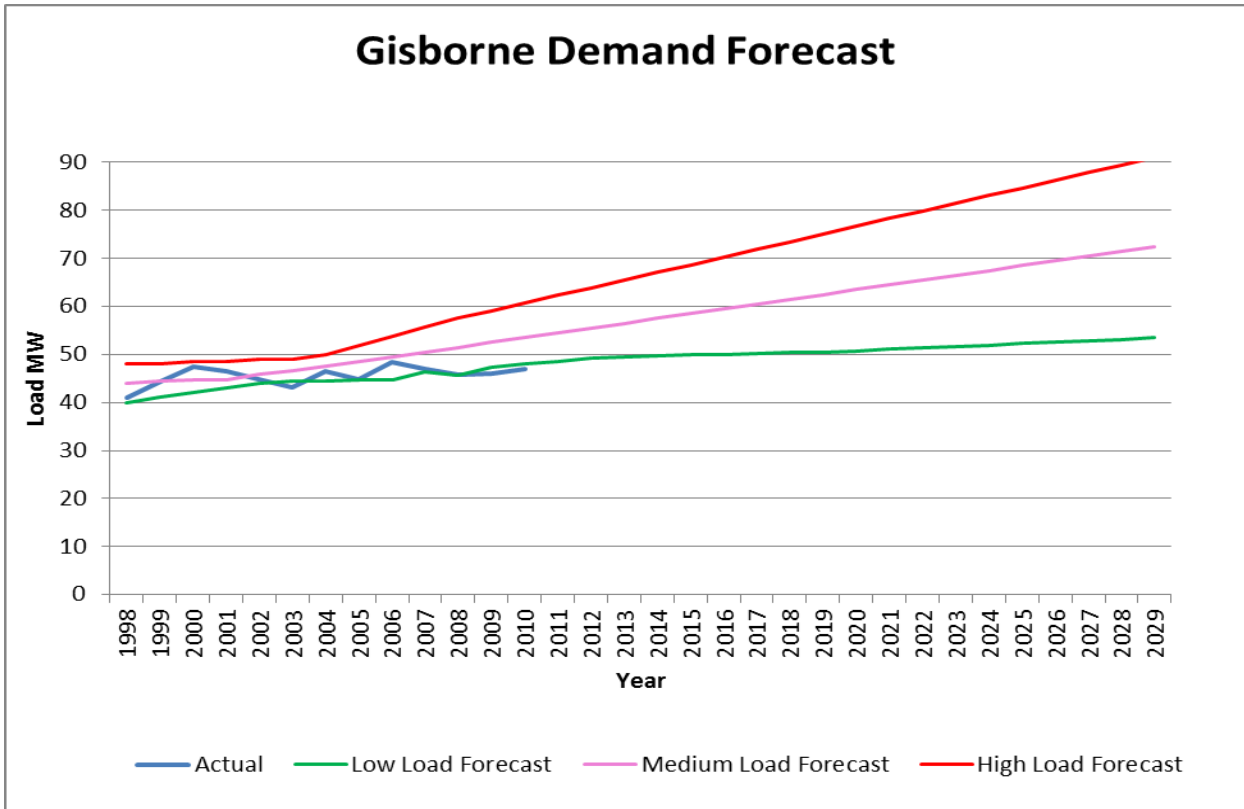

While the forecast demand growth trends are 0 to 1.8% p.a. the historical trend does not clearly reflect this largely due to changing factors such as load control strategies, energy saving drives arising out of national energy shortages and weather patterns.

#### 4.3.6 Forecast Accuracy and Variations

ENL has used a Load Forecasting Model to help predict the impact of accumulated load growth on its capacity requirements and security standards. The model allows scenario planning for investigating the impact of large loads associated with new processing plants and other industrial loads when applied at specific locations in the network. Forward projections of growth rates are obtained from historical trends at feeder level, or sub feeder level where data is available. There is a significant dependence on the experience of the personnel establishing the correct growth rates and their understanding of the patterns in the region.

The model achieves this via the following method...

- Profile Builder: Feeder load data is obtained from the SCADA system. Load profiles are created for domestic, non-domestic, and specific industrial consumers and reconciled so that they sum to known feeder level data.  
Zone substation, sub transmission line, and GXP profiles can then be built up which take into account diversity.
- Load Forecasting: The number of connections and an assumed annual growth rate can vary each profile for each class of consumer.
- Scenario planner: Large loads and generation can be inserted at any sub-transmission node. i.e. Zone Substation. Resulting loads and their profiles can be applied to load flow analysis software to determine voltage, loss and security issues.

ENL has also considered historical and national trends and has found that they provide the most effective method for load forecasting. Consideration is made of regional developments via use of the Load model however past experience has shown that load forecasts provided by end users do not take diversity into account. Only a small proportion of the developments eventuate and in general the forecasts have proven to be inaccurate. To compensate for inaccuracy in load

forecasting the security standards in place provide a buffer to accommodate load growth and allow appropriate time frames to compensate and re-establish the appropriate security.

**Gisborne System Historical Load 2001 to 2011**

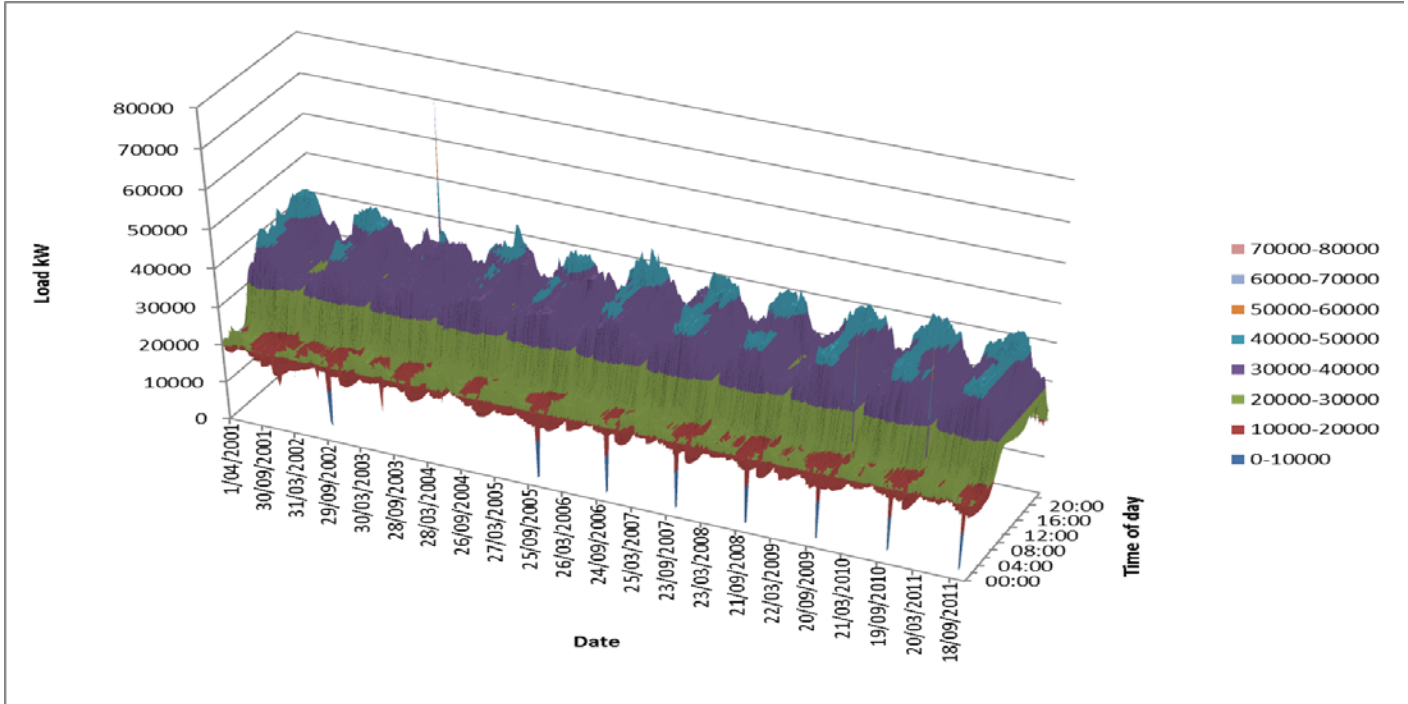

**Wairoa System Historical Load 2001 to 2011**

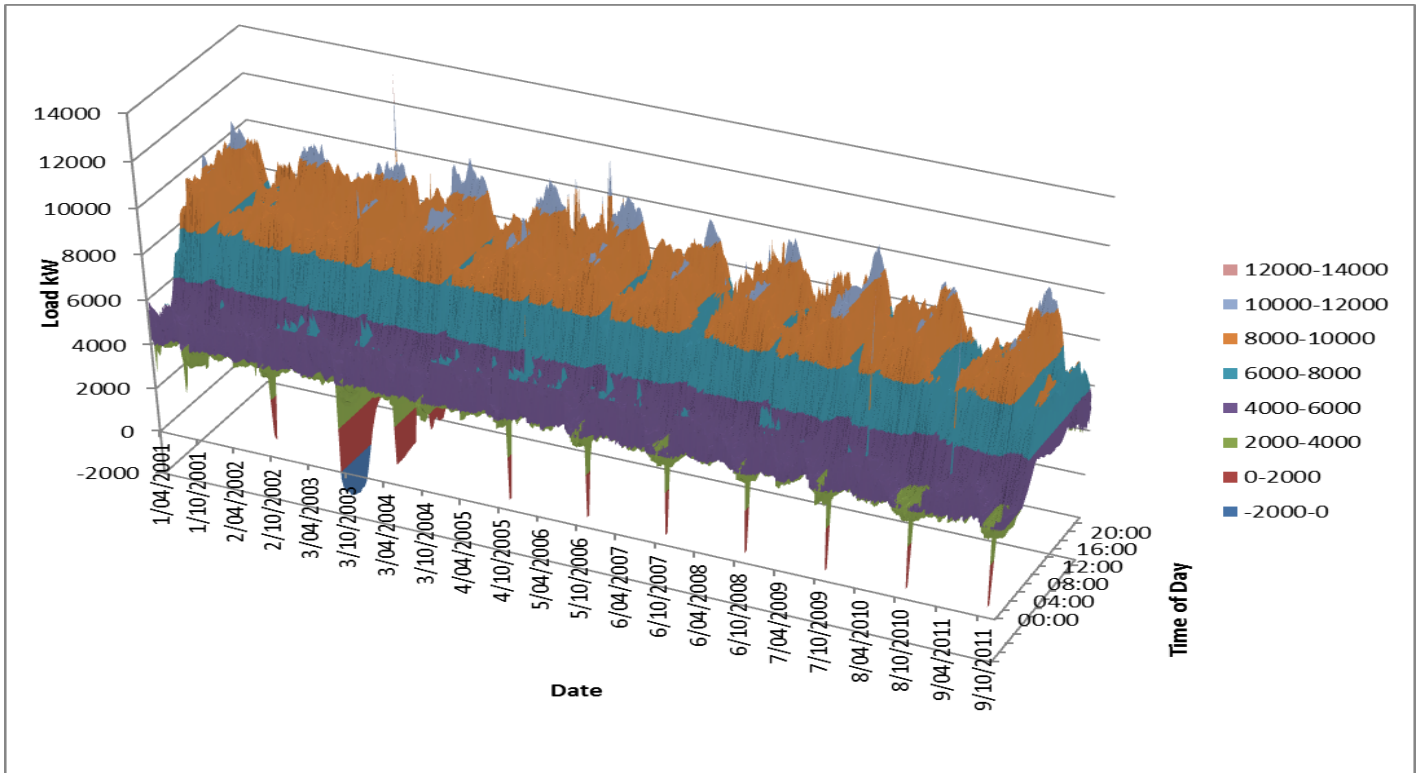

Shown by the charts above all demand forecasts are subject to variation as a result of externalities such as weather and economic growth. Annual variations in these factors will create demand variations in the short term, whilst sustained trends are likely to cause more persistent departures from the forecast. The Gisborne trend above shows a sudden change in the demand profile from 2002 periods. This change was due to a change in load control strategies from 2002 and the national campaign to save energy due to water storage levels in 2003.

Varying the timing of planned work can accommodate forecast variances. Lower than expected load growth can be accommodated by deferral and faster than expected load growth by acceleration. Adequate notice is generally available for the type of work involved to undertake such acceleration, although major items of equipment can have long lead times and constrain the extent to which work can be performed 'just in time'. ENL's basis for network planning and operations is sufficiently rigorous and conservative to avoid serious capacity shortages and un-served demand.



ENL does not manage the transmission system planning. When presented with a transmission issue by Transpower ENL assesses opportunity for alternative investments that may deliver lower cost, (i.e. embedded generation) Responsibility for delivery of transmission capacity and security and the associated investment risks belong to Transpower.

### **4.3.7 Issues arising from estimated demand**

The only confirmed issue arising from the estimated demand is the possible increase in demand around Matawhero as the impending forestry harvest is processed. As outlined in section 4.3.2.1 ENL expects to supply between 7MW and 10MW of additional demand by 2016. The Matawhero substation is expected to be adequate to meet this increase.

## **4.4 Capacity constraints**

### **4.4.1 Bulk supply constraints**

#### **Gisborne Point of Supply**

The worst case forecast is that the 60MVA fixed capacity at Gisborne GXP is sufficient to meet increasing maximum demands until approximately 2018. Beyond this, to meet increasing demand, the construction of a third 110kV line from Tuai and/or the installation of significant embedded generation will be required.

#### **Wairoa Point of Supply**

The worst case forecast is that the 10MVA fixed capacity at Wairoa GXP when combined with the contribution of 3MW from the embedded hydro generation is sufficient to meet increasing maximum demands until approximately 2022. It is proposed that at this time the current 110/11kV transformers would be upgraded to 110/33kV units.

Development plans for the Wairoa sub-transmission network are being progressed to coordinate with this upgrade.

### **Tuai Point of Supply**

There are no current or forecast capacity constraint issues arising at the Tuai GXP. If any significant growth were to occur over time additional security measures will be required. Development of standby generation options to meet the necessary security levels is the most viable option at this time.

### **Tuai Transmission Supply**

Operationally at Tuai the 110kV lines to the Gisborne, Wairoa and Tuai GXP's are connected to a ring bus via a coupling circuit breaker that is not equipped with bus protection. Hence any fault on the 110kV bus at Tuai will interrupt the entire supply to ENL. In addition failure of a double circuit 110kV tower on either the Gisborne or Wairoa Lines will interrupt the entire supply to the respective GXP. Transpower have advised that this risk is managed and in line with their National standards.

## **4.4.2 Sub-transmission constraints**

ENL's only current sub-transmission constraint is the Mahia 33kV line which is currently limited to 1.5MW. Following the 33kV extension project the limit will be 2.5MW.

## **4.4.3 Distribution constraints**

In ENL's overhead network the constraint is generally driven by voltage drop. A nominal design standard of 3.0% is applied to new lines or connections to the existing lines. Voltage drop is permitted to reach 5% before reinforcement is considered or application for new load is declined. Other factors such as the need for contingent capacity to meet security needs are also considered.

Cable network tends to be more constrained by thermal ratings. Therefore underground systems are less tolerant of constraints.

ENL has identified the following distribution constraints...

- Tikitiki Feeder Ruatoria – Limited transfer capacity between substations

- Inland Feeder Tokomaru Bay– Limited transfer capacity between substations
- Mata road feeder Tokomaru Bay – Very long feeder
- Tauwharepare Feeder Tolaga Bay - Very long feeder
- Dalton Feeder Kaiti Anarua Bay feeder is voltage constrained over holiday periods. Hence only isolated new loads could be supplied.
- Nelson Road Feeder Makaraka
- TeArai Feeder Patutahi - Very long feeder
- Tiniroto Feeder Pehiri - Very long feeder
- Tahora Feeder Ngatapa - Very long feeder
- Whatatutu Feeder Puha- Very long feeder
- Matawai Feeder Puha Additional load would require a voltage regulator and ultimately a 50/11kV zone substation.
- Muriwai feeder Patutahi can only supply around an additional 200kVA of load, up to halfway along the feeder otherwise the voltage would be unacceptably low.
- Frasertown and Raupunga feeder's remote connections are currently limited by voltage. This will preclude all new load other than isolated single dwellings.
- Mahia Feeder Blacks Pad – High point loads at ends of feeder
- Ruatakuri Feeder Tuai - Very long feeder
- Hicks Bay Feeder TeAraroa - Very long feeder

Relief of all of these constraints typically requires significant customer contribution as the required investment is unlikely to be covered by the allowable revenue.

#### **4.4.4 Significant consumer constraints**

In general significant consumers have supplies tailored to their requirements. Consumers requiring increases in capacity are effectively constrained by the minimum investment they initially undertook.

#### **4.5 Use of non-asset solutions**

Covered in section 4.2.1 ENL considers a range of non-asset solutions including smart technologies, third party generation and network reconfiguration. ENL's preference is for solutions that avoid or defer new investment.

## **4.6 Policies for distributed generation**

ENL clearly recognises the value of distributed generation in the following ways...

- Reduction of peak demand at Transpower GXP's.
- Reducing the effect of existing network constraints.
- Avoiding investment in additional network capacity.
- Making at least a small contribution to supply security.
- Making better use of local primary energy resources thereby avoiding line losses.
- Avoiding the environmental impact associated with large scale power generation.

As many of these benefits are only realised if the generation can reliably and consistently perform when needed, wind, solar and run of river hydro generation are generally not able to make any significant contribution. Where there is no guarantee that the generation can offset transmission costs ENL is usually unable to contribute to the benefits until savings have been identified.

ENL also recognises that distributed generation can have the following undesirable effects...

- Increased fault levels, requiring protection and switchgear upgrades.
- Increased line losses if surplus energy is exported through a network constraint.
- Stranding of assets, or at least of part of an assets capacity.
- Reduction in asset utilization without the ability to remove the asset
- Instability of the network during faults and interaction with existing generation

- Deviation of voltage beyond allowable limits and voltage stability issues.
- Increased loading on assets to accommodate power factor requirements of induction generators
- Harmonic interference
- Automatic reclosing creating synchronising issues

Despite the potential for some undesirable effects, ENL actively encourages the development of distributed generation that will benefit both the generator and ENL. As per the Electricity Industry Participation Code 2010 Part 6 (Connection of Distributed Generation), details on the processes necessary and information required to enable connection of DG to ENL's assets are available in the Eastland Network section of the Eastland Group website, ([www.eastland.co.nz](http://www.eastland.co.nz)).

The priority's for fault restoration and repair work are determined on the basis of the nature and number of customers affected, the available resources, locations, environmental conditions and estimated repair times. In general generation only connections are expected to have a lower priority assigned than load using customers with greater dependence on their electricity supply. Hence outage/repair times for generation may be greater than disclosed averages for outages and service levels may be lower.

The key requirements for those wishing to connect distributed generation to the network broadly fall under the following headings.

#### **Connection terms & conditions (commercial)**

- Connection of distributed generation to an existing connection will not incur any additional line charges if the capacity of the connection does not alter. Connection of distributed generation requiring capacity greater than the existing connection may incur additional costs to reflect network reinforcement.
- Distributed generation that requires a new connection to the network will be charged a standard connection fee, and may also be charged a fee to reflect reinforcement of the network back to the next transformation point.

- Variable and fixed line charges will be payable by the connecting party to ENL.
- Installation of suitable metering (refer to technical standards below) shall be at the expense of the distributed generator and its associated energy retailer.
- ENL recognises and shares the benefits of distributed generation that arise from reducing ENL's costs (such as transmission investment costs, or deferred investment in the network) provided the distributed generation is of sufficient size to provide real benefits. Separate contracts for recognition of benefits will generally be fixed term and renewable if the benefits still exist. Penalties will apply to contracts if the benefits are not realised.
- Those wishing to connect distributed generation must satisfy ENL that a contractual arrangement with a suitable party is in place to consume all injected energy.

### **Safety standards**

- A party connecting distributed generation must comply with any and all safety requirements promulgated by ENL.
- ENL reserves the right to physically disconnect any distributed generation that does not comply with such requirements.

### **Technical standards**

Prior to connection of an installation ENL will require evidence that all matters relating to regulatory compliance have been met. This may include but is not limited to

- Easements
- Resource consents
- Building consents
- Asset Capability Statement and approval from the System Operator
- Safety Management Systems
- Electrical compliance certificates

Metering capable of recording both imported and exported energy must be installed. If the owner of the distributed generation wishes to share in any benefits accruing to ENL, such metering may need to be half-hourly.

ENL may require a distributed generator of greater than 10kW to demonstrate that operation of the distributed generation will not interfere with operational aspects of the network, particularly such aspects as protection and control.

All connection assets must be designed and constructed to technical standards not dissimilar to ENL's own prevailing asset management standards.

While specific analysis is required on a case by case basis, the maximum injection into the network before voltage limits are exceeded is indicated in the following table.

Location	Nominal Maximum export
Urban 50kV sub-transmission	8 - 20 MW
Rural 50kV sub-transmission	2 - 8 MW
Urban 11kV distribution	3 - 6 MW
Rural 11kV distribution	50% of the typical feeder load 50 - 500kW
Rural 11kV distribution near Zone Substations	1 - 2 MW
Urban 400V Reticulation	100 - 200kW
Rural 400V Reticulation	8 to 50kW

In accordance with the Electricity Industry Participation Code 2010 Part 6 (Connection of Distributed Generation), details of the processes necessary and information required to enable connection of distributed generation to ENL assets is available from the ENL section of the Eastland Group web site.

## **4.7 Development program**

### **4.7.1 Options considered for major initiatives**

As identified in section 1.6 the Wisdom and Understanding inherent in ENL's processes and systems continually filters numerous ideas and options for development initiatives. While many options can be quickly considered and discounted the following options for major initiatives have developed as a result of the process. A ranking of success

outcomes and risk factors for the following development initiatives in this section provided in section 6.2.3.

#### **4.7.1.1 Transmission Development**

##### **Gisborne Point of Supply**

The Gisborne GXP transformer upgrade completed in March 2007 addressed immediate issues related to capacity constraint, meeting future load growth and ENL's security standards.

Additional options available which will incrementally increase the transmission capacity to Gisborne are;

##### **a. 110kV Line Thermal Upgrade**

Medium load forecasts for the Gisborne GXP predict that the 110kV lines summer contingent capacity becomes a constraint in 2016.

Transpower has advised that they are currently carrying out an investigation into improving the summer thermal rating of the line to 60 MW. At this time no information is available regarding the practicalities or cost of achieving this.

However, assuming that it is possible to improve the thermal rating of the line, then the contingent capacity of the Gisborne GXP is increased to 60MW.

Previous graphs show that a contingent capacity of 60MW will under a medium growth scenario become constrained in approximately 2030 and 2020 under a high growth scenario.

Again it should be noted that the deferral of demand growth may be achieved through development of a significant amount of network connected generation if it occurs first.

Scheduled for 2020-2025

##### **b Third transmission Line**

As a potential solution to the eventual 60MW constraint, Transpower has been requested to investigate the possibility of re-conductoring the Tuai – Gisborne 110kV line and installing additional transformer capacity, (a 3<sup>rd</sup> 60MVA transformer) at the Gisborne GXP. Estimated costs of the re-conductor work and additional transformer capacity are \$10 to \$20mill.

It is expected that this solution will not be optimum as the ENL sub-transmission network supplied from the Gisborne GXP will have become constrained. Being installed in predominantly urban areas means that these constraints will not easily be resolved through



enhancement of, or additions to the existing sub-transmission lines also consenting issues will be significant.

The construction of a third transmission line from Tuai is therefore proposed. This 40MW line would terminate at Patutahi where a GXP would be established at the existing ENL zone substation site. Potentially the Gisborne GXP would be transferred to this location and the existing 110kV lines from Patutahi to the Gisborne GXP would be converted to 50kV. The Patutahi location facilitates the "easy" construction of new sub-transmission lines to the Matawhero industrial area where the majority of demand increase is expected to occur. The estimated cost of the new line is \$50mill and the new GXP \$15mill.

ENL has identified a line route from Tuai to Patutahi which can share an existing 11kV line route. The 11kV would be overbuilt with 110kV on concrete poles. A preliminary design of the line has been completed and a process relating to the obtaining of necessary easements is the next stage.

The three 110kV line scenario will provide a transmission contingent capacity to the Gisborne region of 100MW.

Scheduled for 2022-2027 - dependant on growth triggers

### **Wairoa Point of Supply**

There are no constraint issues at the Wairoa point of supply. The contingency rating of the 110kV lines from Tuai is 57MW. The normal/contingency rating of the 2x 10MVA 110/11kV transformers is 20/12 MVA. The maximum coincidental demand of the Wairoa network in 2006 was recorded as 10.75MW. After the application of load control, Waihi generation and Mahia generation the maximum demand at Wairoa GXP is 8.9MW.

Wairoa issues and development proposals relate to sub-transmission and distribution assets only.

Previously it was proposed that the ENL security for Wairoa GXP be reduced to from a C to a B1 classification. This would require only an "n" level of security with 100% contingency capacity such that 75% of the load could be restored within 15 minutes, 90% within 3 hours and 100% restoration dependent upon repair time. Optimisation of the Wairoa GXP to this security level would have halved the quantity and value of assets required and save approximately \$40,000 pa in connection charges. It was proposed that the use of 1.5Mw of load

control and 6MW of embedded generation, (5MW Waihi Hydro + 1MW Mahia Diesel) would compensate for the reduced service levels.

This proposal has now been discounted as it would result in an unacceptable divergence from ENL's security standards. Waihi Hydro only has 3 days storage capacity and cannot be relied upon to deliver 5MW on call. This was demonstrated in March/April 2002 when due to lack of rainfall Waihi was unavailable for evening peak reduction. Under the proposal should an event coincide with Waihi unavailability then a shortfall in contingent capacity would exist which could only be counted through the rationing of supply. The reduction of Wairoa GXP asset also would restrict the availability of capacity for growth.

Under changes in the 2004 ODV Handbook the Wairoa 110kV assets which had been optimised to 50kV were required to be reinstated to 110kV. This resulted in a 7.8%, (\$71,000) reduction in ENL connection charges at that time.

No actions Scheduled

### **Tuai Point of Supply**

Transpower supplies ENL via a single 110/11kV 10MVA transformer at Tuai. The maximum demand at this connection is 650KVA. There is no growth forecast for this connection.

Transpower is keen to rationalize this connection as it will allow removal of assets and create room within their switchyard. It has been proposed in the past that ENL be supplied from the Genesis 11kV bus at Tuai.

Progress on implementing this proposal has stalled due to the requirement to resolve contractual issues between Genesis and Trust Power.

There is also potential to supply this connection via ENL's Tuai and Wairoa 11kV network segments as part of the long term development of Wairoa sub-transmission.

There is no cost pressure associated with rationalising the Tuai connection until Transpower signal that age based replacement of the 110kV transformer.

No actions Scheduled

## Aggregation

ENL has in the past presented a case for aggregation of demand at Gisborne and Wairoa to a single GXP at Tuai. If this were to happen, based on 2004 information the average of the 12 highest demands would reduce by 2.451MW. Based on ENL's 2006/07 transmission charges this would result in a reduction in interconnection charges in the order of \$157,000pa.

Transpower has dismissed this proposal on the basis that it is not permitted by its pricing methodology.

## Transmission Conclusions

Financial information relating to transmission development is provided in Section 6.12.

- Have Transpower continue investigations into relieving 110kV line thermal constraints; (establish 60MW contingency rating).
- Defer development of the option for a 3<sup>rd</sup> Tuai – Gisborne transmission line and GXP establishment at Patutathi.
- Defer development of the option of connecting ENL Tuai and Wairoa network segments.
- Pursue other valuation and optimisation issues should the opportunity arise, (e.g aggregation of GXPs).

### 4.7.1.2 Sub-transmission Development

#### Gisborne Sub-transmission

Within the urban Gisborne sub-transmission network previously identified demand growth triggers have been reached and associated investments have been made to accommodate the expected minimum load growth projections. With the concentration of loads restricted to blocks of less than 12MW, n-1 security is provided without the requirement of dual transformers or large transformers in neighbouring substations being needed to cover contingent events. Sufficient flexibility exists in key parts of the distribution system such as Matawhero, to accommodate forecast industrial load growth. Further development of the 11kV network is on-going but is only undertaken in response to meet firm load growth requirements.

In the long term the ability to upgrade the urban sub-transmission system to address security or capacity constraints is limited and will coincide with transmission constraint requiring a 3<sup>rd</sup> transmission line and new GXP.

Rural loadings are lower than the installed capacities of the sub transmission system. The daily load profile is reasonably flat, and there are few commercial and industrial loads. As the rural loads are relatively low growth is extremely sensitive to even small subdivisions or commercial developments. The ability to accommodate growth too far out from rural substations is also limited.

From an economic viewpoint, high levels of sub transmission investment made in the rural area cannot be justified, but long distances require high voltage and bulk supply has to be concentrated. Security provision would therefore normally require large, redundant assets. ENL has adopted a design approach where security is provided by standby generation support. This approach has the potential to deliver better service, reduce zone substation asset investment, and avoid 11kV network reinforcement cost. Actions undertaken as a result of the installed generation in 2003 have included removal of high maintenance 2nd transformer banks and replacement of outdoor switchyards with indoor 11kV switchboards providing room for generators on existing sites.

Should the rate of growth exceed the expectations the following provisional projects have been identified that are considered sufficient to accommodate medium growth expectations.

- Provisional Whangara Zone Substation 2.5MW. Situated between Kaiti and Tolaga bay substations this substation may be necessary to meet load growth and support requirements in the Wainui Beach area. While medium scale generation prospects in the area may negate the need to establish this substation large scale generation options will potentially require a substation with up to 10MW export capacity in this area. Scheduled for 2017-2019

-Provisional Mangapapa Zone Substation 12.5MW. Situated close to the Transpower Massey Road substation an option has been identified to extend the Transpower 50kV Bus creating 2 additional Bays. The 50kV line to Kaiti and the Coast can then be separated utilising 1 of the additional Bays and a short 50kV line to a new substation can be established to reduce load and increase support for the Makaraka, Carnarvon and Kaiti Substations. Scheduled for 2015-2017

-Provisional Patutahi Zone Substation capacity increase 12.5MW. Situated close to the Matawhero area an option has been identified to upgrade the capacity at this site should a short fall develop in the Matawhero area. The need for this is unlikely however provision is Scheduled for 2019-2021

### Matawai Supply

The Matawai area supplied from the Puha Substation is exposed in terms of ENL's security standard by the single 11kV line from Puha to Otoko hill run over rugged inaccessible terrain. Currently Puha Substation is linked to Patutahi via the 11kV network and supported by a 1MW generator to enable regular maintenance on the ageing transformers.

To overcome the issues installation of a Zone substation at Matawai combined with conversion of the 50kV line from Otoko to Matawai, currently operating at 11kV, back to 50kV has been considered. Alternatively the Ngatapa substation has been identified as a key site in terms of location to provide security and support to the Matawai area currently supplied from Puha substation.

ENL plans to construct a section of 11kV line from the end of the Ngatapa feeder to Otoko Hill under the existing 50kV line route. The cost of the 11kV line while being close to the value of a new substation at Matawai will not only provide for the security requirements of Matawai but will provide the additional benefit of capacity support for both the Ngatapa and Puha substations.

The Ngatapa/Otoko 11kV feeder project is scheduled in the distribution development section of this plan.

Scheduled for 2011/12

### Wairoa Sub-transmission

Wairoa sub-transmission issues relate to capacity constraint at Mahia and capacity availability for the forecast Wairoa CBD growth.

#### Mahia

Mahia is currently supplied at 11kV from a 33/11KV 1.5MVA transformer at Blacks Pad. This transformer is not fitted with on load tap changing capability. This coupled with the length of the 11KV line and current conductor size results in voltage stability issues occurring

when demand exceeds approximately 800KVA. The Mahia Voltage Profile chart below shows the instances of when the 11kV voltage at Mahia is below limits.

Demand requirements at Mahia have increased due to the growth of dairy farming at Mahunga and beach property subdivisions. The current rate of growth is forecast to continue due primarily to continuing subdivision activity. To date demand requirements exceeded the capacity of the Mahia transformer and are very seasonal in nature. This is illustrated by the Mahia Load Profile chart. It is expected that over time this seasonality will not be as evident as more people take up permanent residence at Mahia.

Increasing demand requirements also result in increased voltage stability issues.

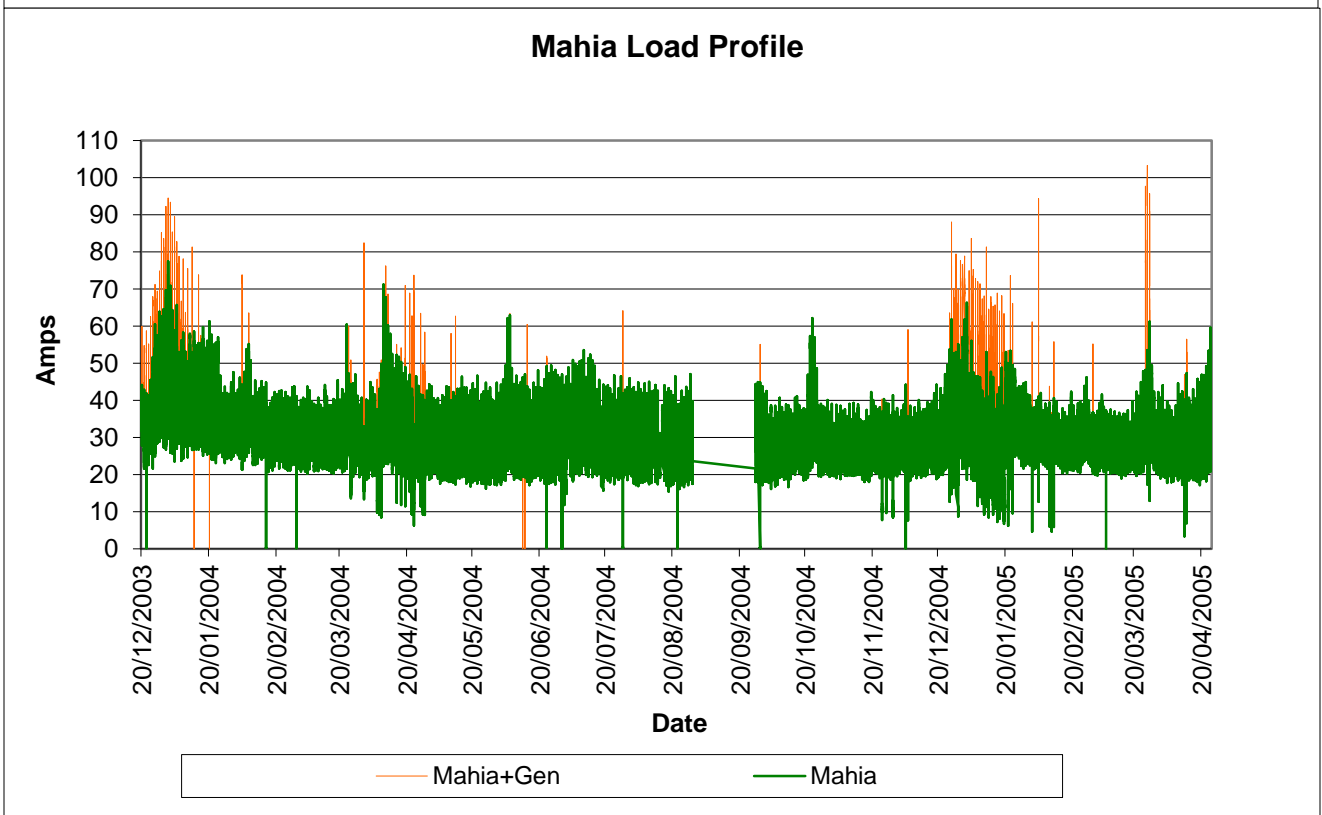
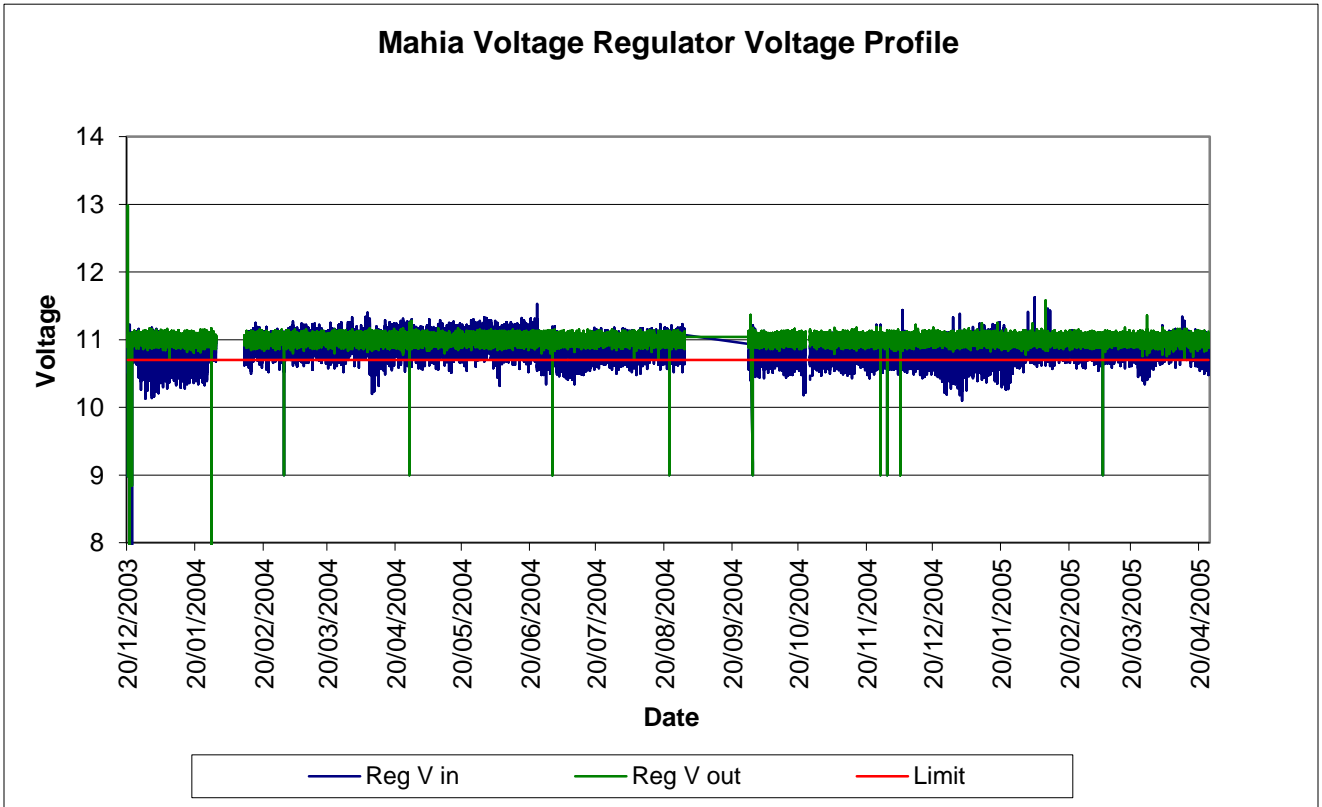

Since 2002 a generator has been installed and operated at Mahia

during high demand holiday seasons to overcome capacity and voltage issues. However with the level of demand growth forecast to increase at Mahia and the expected change in demographics it is expected that the generator solution is limited to a maximum of 2 to 5 years.

Investigation has shown the upgrading of the 11kV Mahia network will not be sufficient to resolve current issues and accommodate increasing demand requirements. The optimum solution is to relocate the Mahia transformer closer to the load source and increase its capacity. This involves extending the 33kV line approximately 6.5km to Opoutama and establishing a small zone substation. The substation would comprise of a 2.5MVA transformer fitted with an on load tap changer.

The cost of this option is estimated at \$1.5 mill. As this expenditure will result in little additional returns to ENL and additional financial contribution is being sourced from the developers in the form of contributions linked to the capacity being developed and their specific requirements.

Implementation of the Mahia development project has been delayed due to continuing challenges with the project including obtaining a suitable substation site and achieving easements over private property for the 33kV line extension.

Scheduled for 2010/12

#### AFFCO & Wairoa CBD

AFFCO's current approximate maximum demand of 4MW is 35% of the total maximum demand (11.6MW) of the Wairoa network. Load increases at AFFCO have a significant influence on the Wairoa 11kV network as a whole. AFFCO is currently supplied at 11kV from Kiwi substation. The maximum capacity limit of this supply is 5MW, after this limit is exceeded the supply to AFFCO will be required to be at 33kV.

AFFCO have advised that in the medium term, (5 to 7 years) expansion of their plant may result in a maximum demand increase to 6.5MW. Also new load associated with sawmilling in Wairoa is forecast in the medium term will take the current contingent capacity of the 11kV network supplied from Kiwi substation.

Potentially opportunities exist to meet specific increased demand increases, (e.g. AFFCO) through embedded generation. Eastland Group /ENL will investigate these opportunities.



The long term option for the sub-transmission development of Wairoa is that the current 110/11KV GXP supply be replaced with 110/33KV. An interim step is that in the medium term AFFCO is supplied at 33KV and the 50KV Waihi line is converted to 33KV and connected at Wairoa instead of Kiwi. This will restore contingent 11kV capacity to Kiwi and be available to supply other Wairoa growth including sawmilling.

The medium and long term options for sub-transmission development in Wairoa are shown on the following schematics. While the first stage of development is underway it should be noted that the final stage is still very much at the investigation stage.

**Medium term 33kV  
Subtransmission  
Development Wairoa**

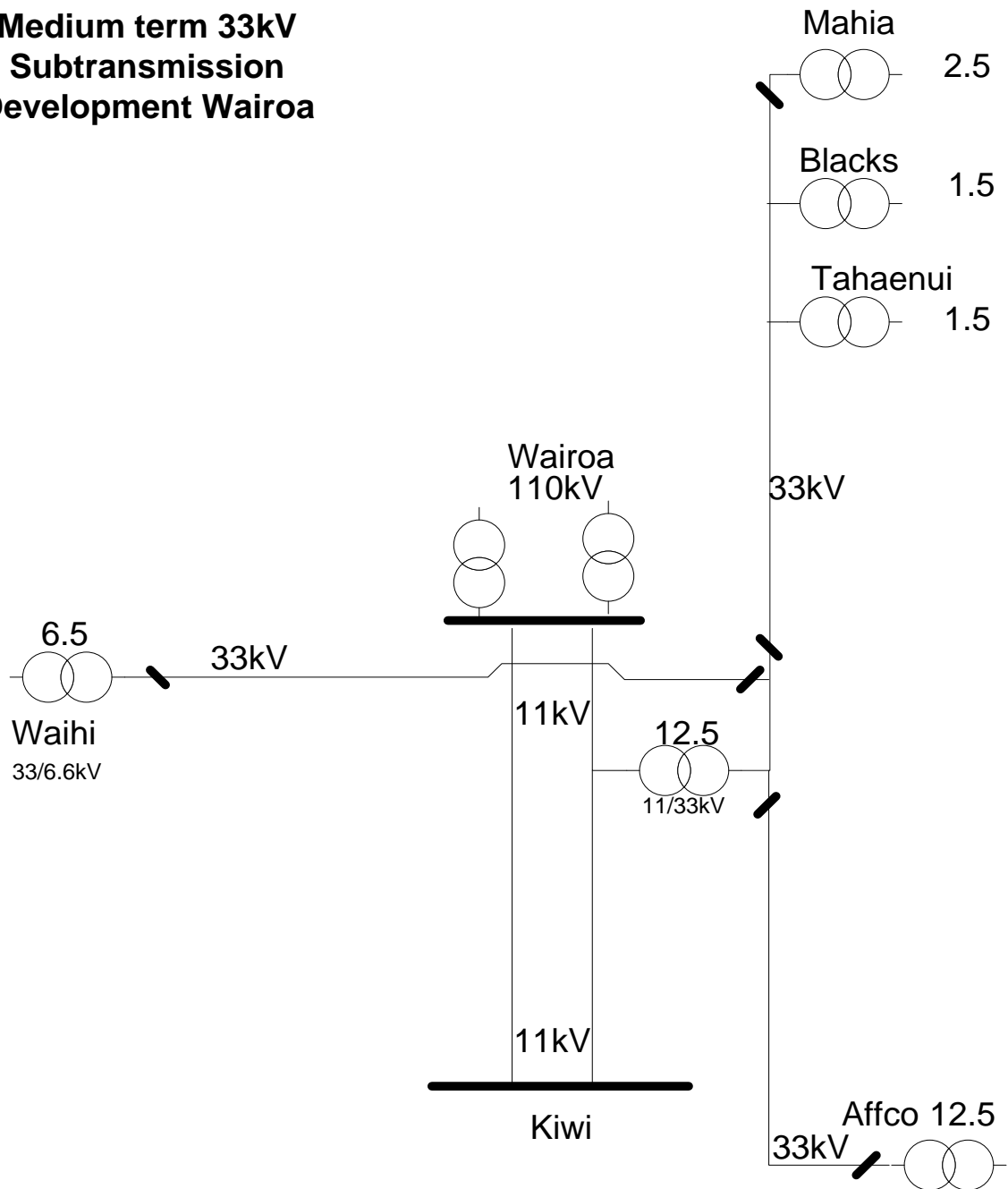

**Long term 33kV  
Subtransmission  
Development Wairoa**

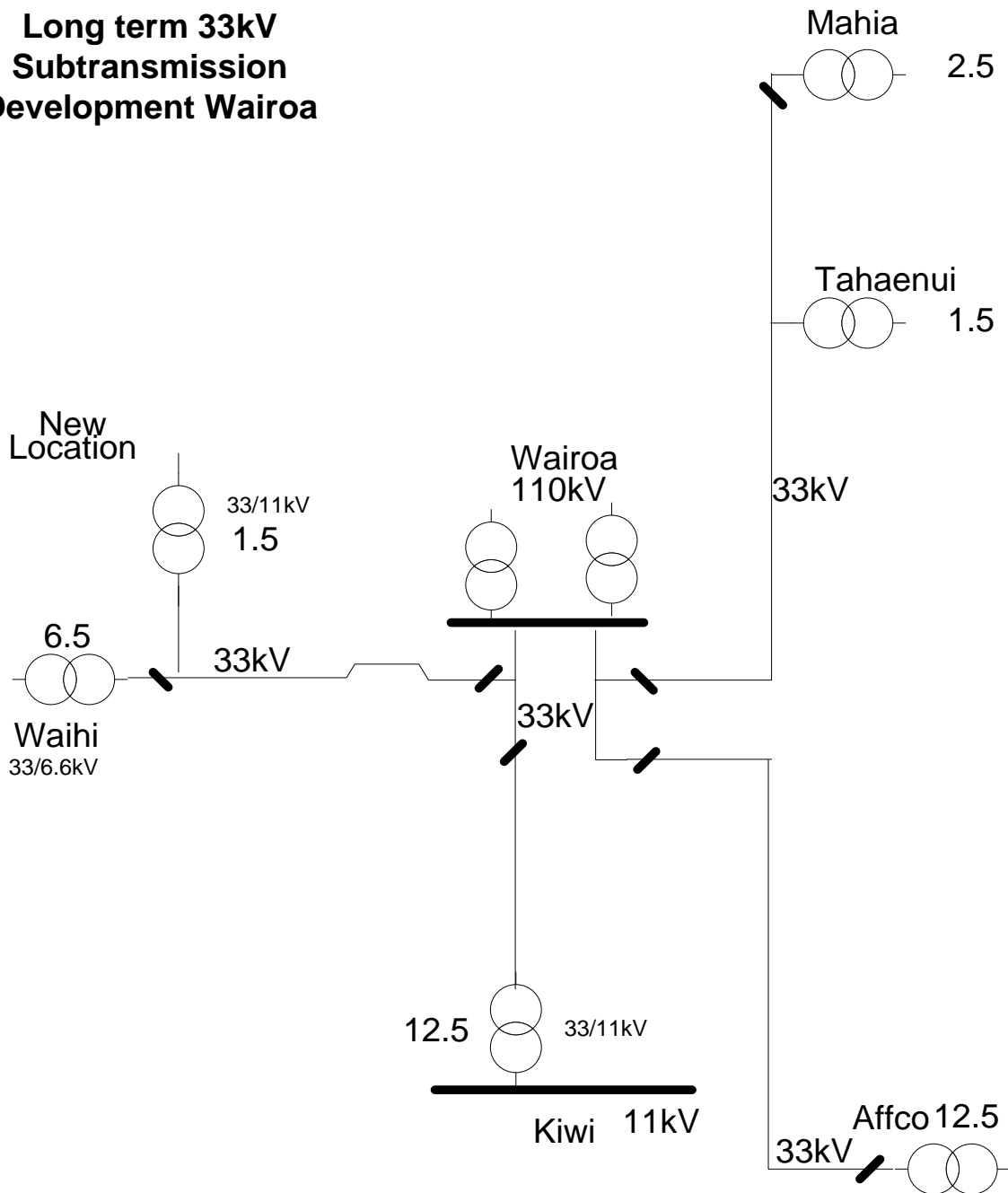

**4.7.1.3 Generation Development**

Investment in generation by EASTLAND GENERATION LIMITED presents a business diversity option as well as being a least cost substitute for expensive transmission and/or sub-transmission investment.

For each development need identified which involves an asset solution, ENL considers alternative solutions including distributed generation. Working with EASTLAND GENERATION LIMITED and other partnerships non-asset solutions are incorporated into development actions where appropriate. The work undertaken in conjunction with Generation partners includes: Water monitoring, Wind Monitoring and Engineering analysis activities. As the activities of EASTLAND GENERATION LIMITED include development opportunities outside the ENL region the internal processes used to develop these alternatives are outside the scope of this plan.

The following daily load profiles show how the use of ENL’s existing embedded generation when operated in conjunction with load control can effectively manage peak load periods creating a flat daily profile. These profiles indicate that there is little scope for additional peaking generation benefiting the overall demand side management of the assets. The contribution of base load generation opportunities is the preferred method to minimise further transmission and sub-transmission investment.

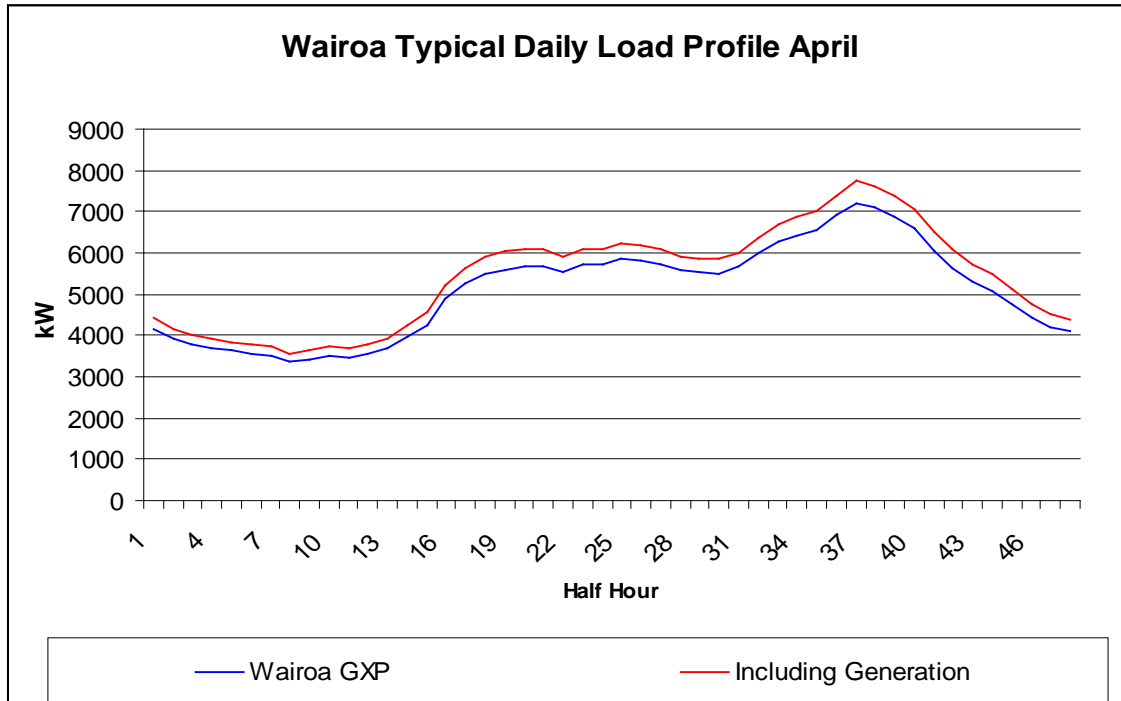

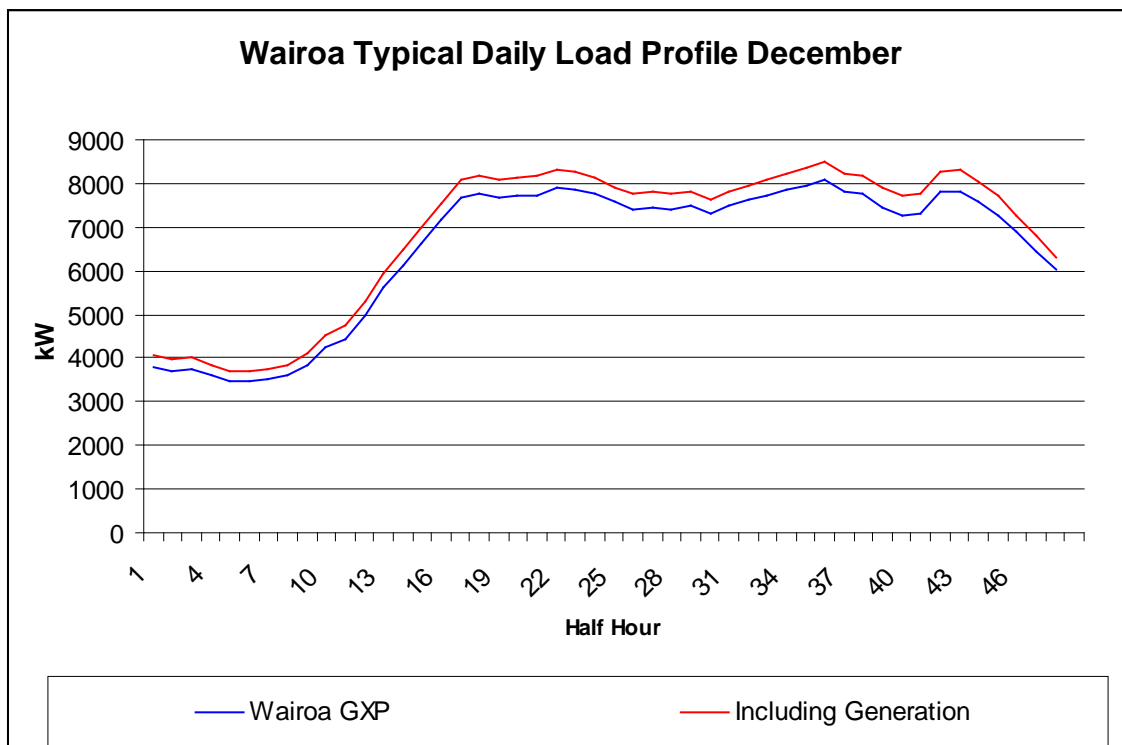
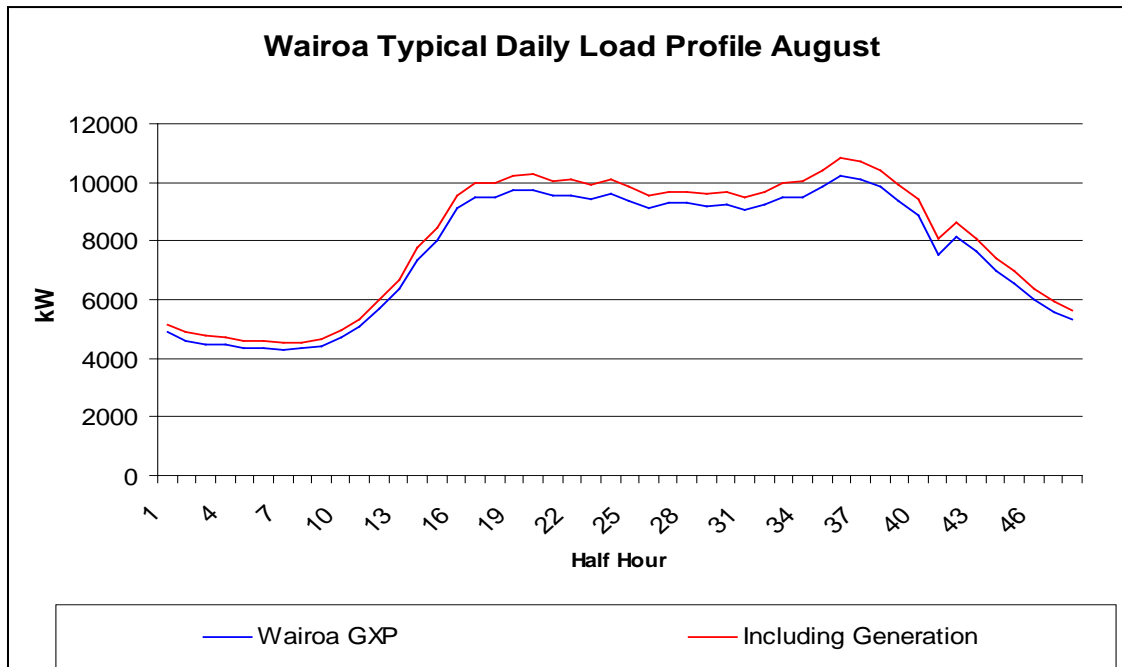

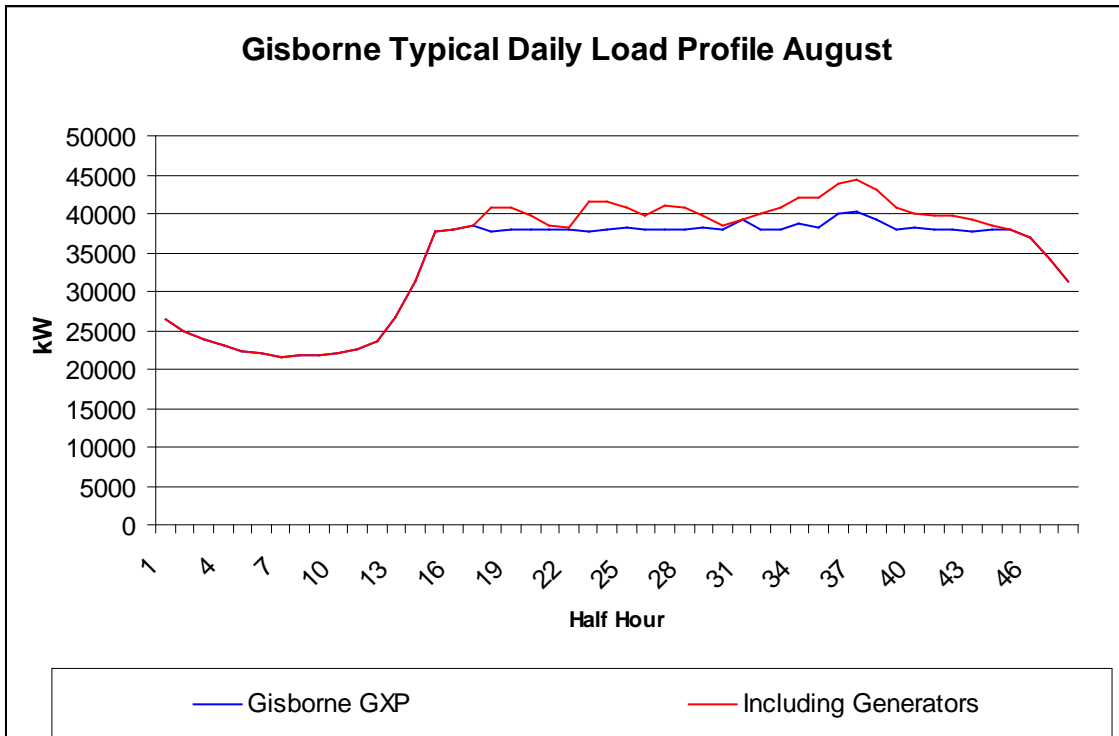
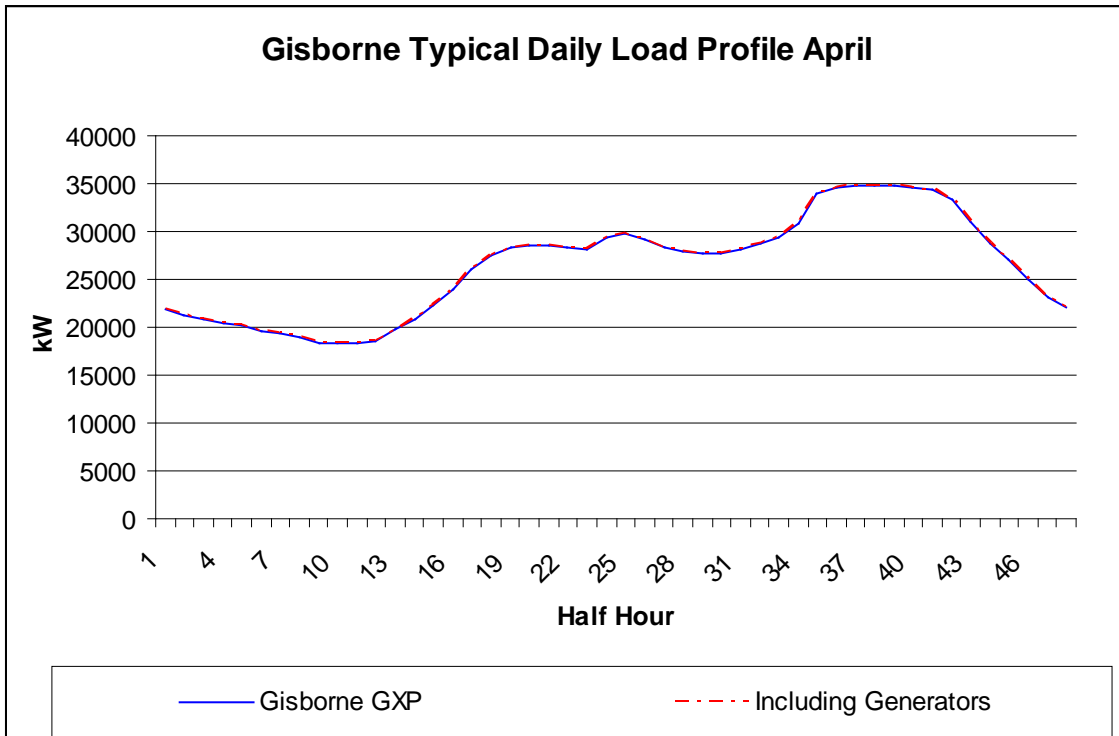

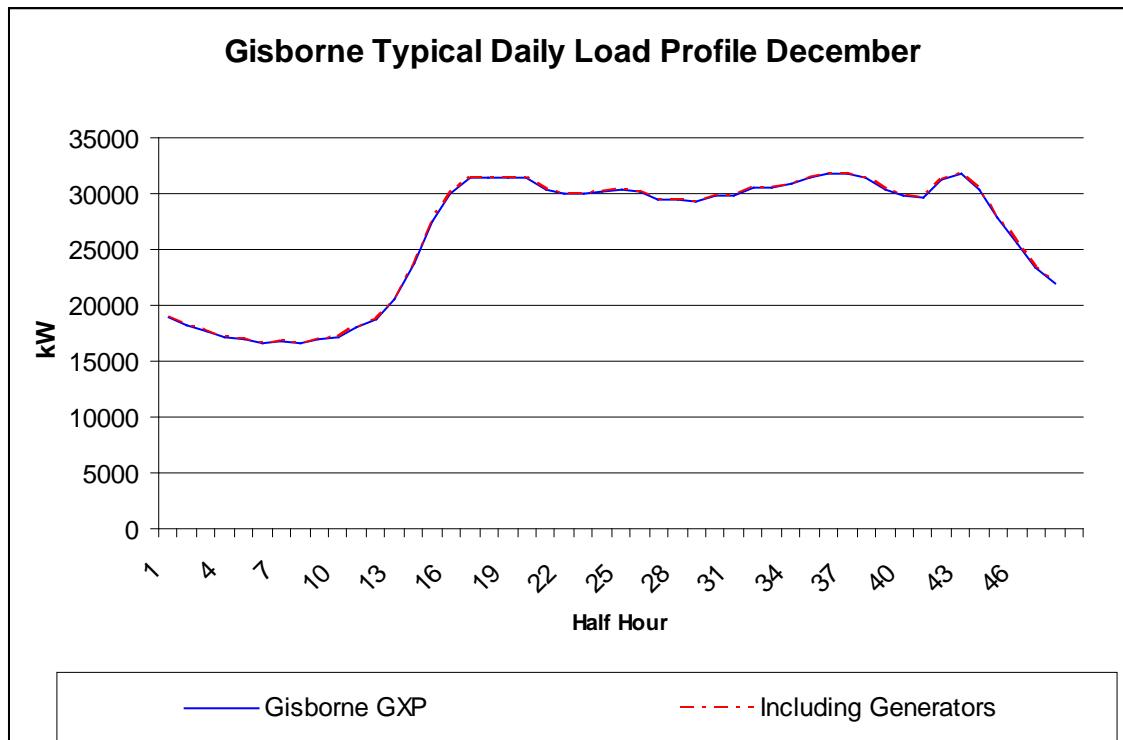

Regular review of alternative generation schemes previously investigated on the East Coast is undertaken. The various schemes investigated included Hydro, Wind, Biomass and Co-generation (utilising natural gas). The reviews are carried out in order to assess the viability of previously investigated generation options with regard to the increasing cost of energy and identify those worthy of implementation.

**Wind**

Monitoring is currently being undertaken at Mokairau, Makarori and Whakapunaki. These sites were thought to show potential; however lack of wind and proximity to the existing distribution network is the primary constraint affecting economic viability. Large scale options have the additional logistical issues associated with road access from Gisborne. Another issue is that should significant development of wind generation occur, further base load generation would have to be introduced. This is to ensure network stability and provide contingent capacity support.

A Provisional allocation to establish wind generation has been identified in the development program should any option become viable.

**Biomass Generation**

A number of proposals to install a biomass plant using waste from forestry and timber industries have been investigated. A site in the Matawhero area would supply the developing large scale industry with both electricity and process steam. Options of this plant are yet to be determined by EASTLAND GENERATION LIMITED and will be based around the requirements of the mill operators.

Studies into residue volumes and delivered price at Matawhero have been completed. The studies identify an economic line within which residue could be delivered to a bio-mass generation facility. The studies indicate some level of forest residue collection is viable. It is likely that this opportunity will be taken up by a third party in conjunction with the development of a new large scale industry.

**Hydro**

In the 1970s and 80s a number of potential hydro schemes on the East Coast were investigated by Eastland Energy. With changes in the economic environment with respect to generation EASTLAND GENERATION LIMITED continues to reviewing these opportunities.

In addition to its own investigations, EASTLAND GENERATION LIMITED is liaising with private investors who have identified other potential hydro schemes within the Gisborne and Wairoa regions.

Waihi Power Station improvements include the possibility of increasing the storage capacity of the dam by dredging sediment from the lake floor, and/or by raising the height of the existing dam wall. Investigations have proven both these proposals to be uneconomic at this time.

**Gas Co-generation**

Investigations into Gas Cogeneration have shown it to be uneconomic without process heat off take. There are also constraints on the regions gas supply, limiting any generation to around 6MWe. To make this type of generation cost effective it is imperative that an industry capable of utilising the process heat is found (e.g. timber drying). Also access to long term supply of gas with price certainty is required. EASTLAND GENERATION LIMITED continues to review any opportunities should they arise.

**Customer installed Standby generation**



Some opportunity exists for ENL to utilise customer installed standby generation as peaking plant. This opportunity is however limited as few industrial customers in the region have at this time felt it necessary to make provision for or invest in security of supply. Currently the existing customer generators are not suitable for use in a peaking role without significant upgrade cost. The reduced life expectancy and increased maintenance cost in a peaking role when compared with the targeted life of the equipment in a standby role are additional issues affecting the viability of these options currently.

### **4.7.1.4 Distribution Development**

#### **Security reinforcement due to Growth**

Section 4.4.3 of this document identifies when growth will or has caused 11kV capacity constraints either in terms of demand or more commonly in terms of voltage stability over distance.

Feeders selected for duty as tie feeders providing contingency capacity to other feeders/substations need to maintain spare capacity.

CBD expansion necessitates the upgrading and development of reticulation in specific areas of the Gisborne and Wairoa CBD's. This upgrading includes the undergrounding of existing overhead circuits on the CBD fringe with allowance for capacity upgrade.

In cases involving upgrade of existing lines or cables the justification for the identified projects incorporates a renewal component that has not been included in the renewal projections. Refer section 5.4.

11kV Lines and Cables that need to be upgraded for growth within the next 10 Years are indicated below. The cable projects are small in nature involving upgrades of old cables to a larger size.

As these projects have similar success outcomes and risk assessment factors the rating of these options are the same and identified as having a reasonably high priority in section 6.2.3.

Year	Location	Existing Size	New Size	Cost
2013/14	Ngatapa to Otoko Hill (50kV Underbuild line) 8km	N/A	Dog	\$ 250,000
2014/15	Stanley Rd cable link for Anzac and Awapuni Road	N/A	300mm Al	\$ 150,000
2015/16	Wainui link Sponge Bay to Lloyd George line, 1.55km	7/14cu	300mmAl/Dog	\$ 135,000
2016/17	Moana Rd Bypass Dalton Feeder 1.4km	N/A	300mm Al	\$ 240,000
2018/19	Plunket Sub to Ormond Rd (Peel St Bridge)	70mm Cu	300mm Al	\$ 100,000

2018/19	Kahutia St Feeder cable (Carnarvon-Barry)	70mm Cu	300mm Al	\$	275,000
2019/20	City Feeder cable (Carnarvon-Pac'N'Sav)	70mm Cu	300mm Al	\$	140,000
2020/21	Gladstone to Hirini Street cable	95mm Al	300mm Al	\$	80,000
2022/23	JNL to Makaraka link , line	N/A	300mmAl/Dog	\$	200,000

Allowances to accommodate growth triggered 11kV line network extension work typically arising and completed during the financial period are as follows.

Lines                                      1.0km p.a. @ \$90,000/km = \$90,000

Cables                                      0.5km p.a. @ \$200,000/km = \$100,000

### Development of Load Control System

Identified as an opportunity to optimise network performance and defer investment in demand side growth, options for development of the load control system has been considered. The main disadvantage identified is the inability to provide reliable control and achieve the necessary benefits. In addition there is a lack of incentive for consumers to invest in energy storing appliances which limits the effectiveness of any investment. Without products that are tailored to, for example, hot water cylinders of different sizes, there is no incentive to install storage capacity.

Control in the non-domestic sector is at present virtually non-existent. There is a potential market for controlled products specific to dairy sheds, irrigation and freezer loads. A further option that can be offered to businesses is supply with lower security levels, for example, a “first off – last on” priority load control for non-essential load such as air-conditioning.

Since ENL is dependent on retailers passing through pricing to consumers, there is a major barrier to optimise load control. Concerns in the industry over this perceived lack of retail sector maturity are likely to be addressed at some point.

In 2000 the Gisborne city load control system included a significant amount of outdated pilot control. This was a hardwired cascaded relay system that had high maintenance costs. Because the system could only support one control option it could not be tailored to different loads. The system had no potential to capture the entire controllable load.

From 2000 to 2008 the Gisborne pilot system was replaced with ripple receivers to minimise ongoing costs. While the project successfully

eliminated the high maintenance costs the entire system relies on a single injection transmitter.

Wairoa has a particular problem due to the frequency selected for its ripple control system. High frequency signals have difficulty propagating through networks and therefore control is very unreliable for the rural portion of the Wairoa controllable load. Load control development in Wairoa is further complicated in that the incumbent energy retailer owns the signal receiving equipment.

The Wairoa CBD and township operates on a pilot system with a centralized control point. Investigation of options for replacement of the existing Wairoa plant do not realise sufficient benefits currently. The best option at present is to maintain the pilot wire system with a view to shutting down the injection plant when it fails.

- Bypass the existing Wairoa load control plant providing direct control to the pilot system in the CBD.

#### Summary of Actions

- Install 2nd Injection point Gisborne deferred indefinitely until sufficient benefits improve viability.
- Monitor the viability of a new load control plant and frequency change at Wairoa while maintaining the pilot wire system.
- Monitor opportunities to implement demand side management. Currently no effective opportunities identified

#### Network Loss Reduction

Distribution network companies do not suffer any significant cost penalty for high losses. Hence there is little investment signal for reducing losses. This would imply that if voltage standards can be maintained in line with the regulations then it is a valid commercial approach to minimize capital upgrades by not maintaining low loss levels. Where security provision by way of interconnectivity is prominent and reserve capacity is built into the network for growth, overall loss figures are likely to be lower.

It can also be argued that it is more economically efficient for the community to pay for losses than to fund capital expenditure on conductor size and/or voltage upgrades to decrease losses, particularly on rural feeders with poor economics. Where transmission is constrained the value of reducing losses can be measured against:

- 1) The cost of kWh of avoided transmission (i.e. imbedded generation)
- 2) The cost of new investment to increase transmission capacity

Networks also have an obligation to manage their networks to good industry practice.

While voltage problems are not widespread on the network they do exist. An indicator of high losses is voltage sensitivity to load regulation. These issues are regularly evident in the following areas within ENL's network.

- Frasertown-Raupunga ring  
Essentially distance is beyond the capability of 11kV reticulation and sub transmission support is required.
- Mahia  
A large seasonal load at the end of the feeder suggests conductor reinforcement and sub transmission extension is required.
- Matawai  
Load, distance and voltage contribute to marginal performance.
- Whangara  
The long distance between Kaiti and Tolaga substations combined with high growth at Wainui is exceeding the conductor capacity and the Tatapouri voltage regulator limits.
- Ormond  
Load, distance and voltage contribute to marginal performance

While losses are higher in certain other locations the number of supplies affected is small and load diversity may mitigate this to some degree. If the areas identified above were to see significant load growth, voltage performance would quickly become unsatisfactory.

When designing new or replacement networks the following loss standards are applied.

Design Loss Standards	Design %	Max. %
Sub transmission Lines	1	2
Zone Transformers	1	2

Distribution Lines	3	5
Distribution Transformers	2	4
LV Distribution	3	6
TOTAL	10%	19%
<u>Non-network losses</u>		
Service Line	3%	
Metering	2%	
Installation	3%	
TOTAL	8%	

## Loss Analysis

ENL's total system losses are around 8.2%. The losses can be further broken down to technical and non-technical losses. While the dynamics of the network load makes calculation of technical losses impractical use of load flow analysis applied to a snapshot of the network may provide a relative comparison or distribution of losses for the network segments. Using a snapshot load of 1 standard deviation above the normal average load and a load distribution based on installed transformer capacity, the total loss for the Eastland Network's high voltage network was determined to be 3.1 %. This figure being made up of 50 kV line losses of around 0.8%, 11 kV line/cable losses of around 1.1% and the losses from the zone substation transformers of around 1.2%. The average loss of the Eastland Network's Low Voltage network was determined to be in the region of 2 %.

Old zone transformers offer the greatest opportunity to reduce losses on ENL's network. There are 4 banks of 4 single-phase units on the network. These transformers have losses in the order of 6% as a result of the following factors:

- High loss iron (all pre-1964 development using steel alloy).
- 4 separate units contain more iron to magnetize.
- Sub-optimal load.

In all cases savings in losses and reduced maintenance justifies replacement with modern 3-phase IMP units within a 25 year pay-back period.

Location	Capacity MW	Losses kW	Value p.a. \$
Tolaga T1	5	300	30,000
Puha T1	5	300	30,000
Patutahi T1	5	300	30,000
Patutahi T2	5	300	30,000

The following table indicates the calculated high voltage losses in terms of load per feeder. When compared to the design standard it shows that there is considerable diversity in losses of components and load (of which loss is a function). High % losses for a given feeder can be an indicator of either low utilisation or an under-designed/overloaded feeder. Hence consideration of each feeder in terms of length, location and purpose is necessary when interpreting the information.

SUBSTATION	FEEDER	Feeder I (A)	Feeder Length (km)	Feeder Vdrop (V)	Vdrop (V/km)	load (KVA)	line loss (KVA)	% losses
Te Araroa	AWATERE	4.49	48.76	180	3.7	99.8	16.0	16.1
	HICKS BAY	13.73	73.52	590	8.0	252.1	21.5	8.5
	TE ARAROA	<u>7.51</u>	<u>13.95</u>	50	3.6	143.1	4.0	2.8
		<b>25.73</b>	<b>136.23</b>					
Ruatoria	RUATORIA	23.78	21.88	50	2.3	467.4	22.1	4.7
	MAKARIKA	9.90	53.47	290	5.4	186.2	19.1	10.2
	TIKI-TIKI	<u>15.98</u>	<u>123.15</u>	380	3.1	324.1	40.5	12.5
		<b>49.65</b>	<b>198.50</b>					
Tokomaru	INLAND	10.55	55.06	400	7.3	217.1	18.6	8.6
	SEASIDE	6.29	6.09	30	4.9	118.5	5.0	4.2
	MATA RD	<u>14.32</u>	<u>129.08</u>	380	2.9	268.3	39.2	14.6
		<b>31.15</b>	<b>190.23</b>					
Tolaga Bay	TOKO-TIE	3.93	38.66	90	2.3	85.9	15.0	17.5
	TOWN	13.84	2.61	10	3.8	259.5	5.0	1.9
	ROTOTAHI	11.88	43.08	120	2.8	227.4	20.0	8.8
	TAUWHAREPARE	<u>8.03</u>	<u>113.78</u>	420	3.7	162.9	35.2	21.6
		<b>37.68</b>	<b>198.13</b>					
KAITI	HERSCHELL	8.92	0.68	0	0.0	160.0	7.0	4.4
	DALTON	45.33	93.18	740	7.9	875.7	37.2	4.2
	TAMARAU	74.75	14.17	230	16.2	1451.2	41.6	2.9
	WAINUI	37.36	3.07	30	9.8	720.1	13.2	1.8
	WHANGARA	<u>34.11</u>	<u>22.26</u>	280	12.6	649.4	30.3	4.7
		<b>200.47</b>	<b>133.36</b>					
CARNARVON	KAHUTIA	35.01	3.68	70	19.0	684.1	33.4	4.9

	CITY	72.16	2.19	40	18.3	1374.9	15.3	1.1
	WATTIES	65.40	3.01	30	10.0	1242.1	35.1	2.8
	ANZAC ST	23.72	2.31	20	8.6	480.0	27.0	5.6
	CHILDERS RD	55.59	5.73	60	10.5	1100.6	51.2	4.7
	AWAPUNI RD	44.36	5.40	50	9.3	855.9	33.1	3.9
	GLADSTONE RD	72.18	6.36	140	22.0	1393.9	72.1	5.2
	ABERDEEN RD	70.62	10.25	160	15.6	1283.8	47.4	3.7
	PALMERSTON RD	<u>68.10</u>	<u>3.04</u>	30	9.9	1290.1	28.1	2.2
		<b>507.13</b>	<b>41.96</b>					
PARKINSON	LYTTON RD	50.08	2.90	60	20.7	951.9	17.4	1.8
	WILLOWS RD	4.45	10.18	10	1.0	88.9	31.0	34.9
	ELGIN	77.91	7.96	140	17.6	1484.2	32.5	2.2
	CHALMERS	56.64	5.43	40	7.4	1098.0	31.1	2.8
	CEDEN CO	94.92	1.16	20	17.3	1800.0	13.3	0.7
	SOLANDIS	44.93	1.54	10	6.5	825.1	21.0	2.5
	INNES ST	<u>10.74</u>	<u>0.84</u>	0	0.0	165.0	12.0	7.3
		<b>339.66</b>	<b>30.01</b>					
MAKARAKA	CAMPION	60.57	9.35	190	20.3	1004.3	46.1	4.6
	NELSON RD	106.38	14.77	450	30.5	1940.6	51.7	2.7
	HAISMAN RD	64.92	38.22	360	9.4	1117.5	46.5	4.2
	BUSHMERE RD	<u>53.84</u>	<u>136.97</u>	720	5.3	964.0	57.5	6.0
		<b>285.71</b>	<b>199.31</b>					
PATUTAHI	LAVENHAM RD	9.77	33.35	90	2.7	192.4	10.0	5.2
	WAIMATA	33.40	65.18	230	3.5	618.0	30.2	4.9
	MURIWAI	24.48	68.79	340	4.9	461.8	34.7	7.5
	TE ARAI	<u>22.67</u>	<u>82.20</u>	350	4.3	425.1	23.8	5.6
		<b>90.31</b>	<b>249.52</b>					
PEHERI	WARENGAO Kuri	9.81	18.10	80	4.4	183.9	4.1	2.2
	PARIKANAPA	1.04	27.01	40	1.5	23.1	6.0	25.9
	TINIROTO	7.29	76.19	510	6.7	138.2	20.3	14.7
	TAHUNGA	<u>3.20</u>	<u>30.93</u>	260	8.4	63.8	9.0	14.1
		<b>21.33</b>	<b>152.24</b>					
NGATAPA	NGATAPA	4.91	30.88	210	6.8	96.5	7.0	7.3
	TAHORA	9.02	84.55	610	7.2	172.4	22.3	12.9
	TOTANGI	<u>0.41</u>	<u>12.06</u>	110	9.1	19.5	4.0	20.5
		<b>14.34</b>	<b>127.48</b>					

PUHA	WHATATUTU	14.07	95.62	380	4.0	284.7	28.5	10.0
	KANAKANAIA	12.95	43.23	260	6.0	249.4	17.0	6.8
	TE KARAKA	12.66	28.22	140	5.0	245.8	9.1	3.7
	MATAWAI	<u>26.07</u>	<u>230.17</u>	450	2.0	503.2	59.8	11.9
		<b>65.75</b>	<b>397.24</b>					
JNL	JNL	192.28	2.68	40	14.9	3604.3	11.7	0.3
MATAWHERO	DUNSTAN	59.13	3.26	80	24.5	1115.3	9.2	0.8
	JNLA	117.86	4.78	130	27.2	2172.7	18.2	0.8
	WAIPOA	41.65	1.22	40	32.8	787.5	18.1	2.3
	BELL RD	<u>21.95</u>	<u>18.75</u>	80	4.3	410.3	19.0	4.6
		<b>240.59</b>	<b>28.01</b>					
PORT	PORT	6.15	2.28	0	0.0	130.1	29.0	22.3
	CRAWFORD	44.30	7.43	30	4.0	841.7	15.1	1.8
	ESPLANADE	92.53	7.06	30	4.2	1749.9	81.1	4.6
	HARRIS	<u>97.33</u>	<u>7.82</u>	60	7.7	1796.8	38.4	2.1
		<b>240.31</b>	<b>24.60</b>					
KIWI	BRICKWORKS/ RAUPUNGA	36.98	217.83	750	3.4	614.9	59.9	9.7
	AFFCO	148.29	8.81	280	31.8	2651.3	85.7	3.2
	NUHAKA/ FRASERTOWN	50.66	252.58	630	2.5	952.2	76.1	8.0
	BOROUGH 1	73.59	10.81	160	14.8	1332.0	51.5	3.9
	BOROUGH 2	<u>103.87</u>	<u>12.13</u>	180	14.8	1823.7	63.9	3.5
			<b>413.40</b>	<b>502.15</b>				
WAIROA	BLACKS	33.72	95.09	300	3.2	592.9	23.8	4.0
	TAHAENUI	<u>17.49</u>	<u>64.29</u>	280	4.4	328.8	23.4	7.1
		<b>51.21</b>	<b>159.38</b>					
TUAI	TUAI	23.94	133.77	1040	7.8	465.3	60.9	13.1

Despite losses being high in terms of percentage, on some rural feeders the cost of re-conductoring is prohibitive unless needed for other reasons or attended to as part of a renewal program.



While ENL does not bear the cost of network losses it does bear cost of increased demand and transmission upgrade if losses are significant.

Reducing ENL losses is a relatively expensive although justifiable option for gaining 1MW of transmission capacity. Economics favor concentration on reduction of losses contributed by the older zone transformers on the system.

### **Power Factor Correction**

Identified as an opportunity to optimise network performance and defer investment in capacity upgrades, options for improving levels of power factor correction have been considered.

ENL pricing conditions require all network connections to maintain a power factor of 0.95 lag or better. Consequences of not meeting this requirement is that ENL reserves the right to apply a higher demand tariffs fixed daily charge to the ICP until the power factor issue is remedied.

Power Factor is poor in most rural areas of the network and correction would increase capacity at the 50 kV Gisborne bus by approximately 900 kW. This poor performance is the result of inadequate policing of standards for connection of motors.

The approaches to addressing this are...

- Installations are reviewed on a regular basis and customers notified of the need to add capacitors/correction. ENL believes that the most effective approach for dealing with non-compliance is penalty payment via pricing rather than attempting disconnection.
- Selected feeders can be corrected in bulk via the installation of static capacitors. As identified in the loss analysis, approximately 7 feeders on the network are considered suitable for the application of reactive compensation by capacitors. This viability of this option is generally restricted to rural feeders where loads are less than 400KW. And losses exceed 5%. The capacitors are expected to cost in the order of \$40,000 per site. There is currently no commitment to this option as distributed generation strategies are expected to provide for voltage support, reducing losses at high load times.
- Additional capacitance could be installed as an option at the Transpower substation but this is the most expensive option and does not realise the benefit of reduced network losses. This option is not being pursued at this time.

## Uneconomic Rural Lines and Connections

Twenty percent of ENL distribution lines, are considered uneconomic. Calculation of value objectives has indicated the need to reduce value in remote and rural areas and hence improve the economic performance of these network segments or current levels of subsidisation by urban customers will need to be maintained or increased in the future. The option of disconnection of uneconomic lines will have negative potential social and economic effects on rural customers and communities hence ENL is currently discounting this option.

ENL has been developing the following strategies for the management of uneconomic lines.

Assets classed as rural and remote will be allowed to age to an average remaining life of 25 to 30 years. Following this the lines will be maintained at this minimum level via a combination of renewal at lower cost, service line handover and cost contribution strategies.

Alternative energy supply options are also expected to be part of the economic outcome and ENL has supported investigation into this technology. Further, ENL supports investigation into embedded generation options.

Renewal of the remote assets at a lower cost design solution can be achieved via reduction to single-phase in place of 3-phase construction. This is limited to lines where the existing customers are prepared to convert 3 phase equipment to single phase or operate it using converter equipment.

Investigation of a number of construction options and voltages has been considered. The most economic solution for the terrain on ENL's network appeared to be 22kV single wire earth return. However other factors including new easement negotiation, telecom interference issues, and re-insulation costs, have now been considered and suggest conversion to single phase 11kV is the most practicable in terms of a viable and sustainable solution.

300km of network in the Gisborne region in uneconomic zones has provisionally been identified as suitable for conversion. Preliminary communications indicate that customer contribution options to fund the rebuild work are unacceptable. In addition there is no mechanism under the Targeted Control Regime to recover costs via specific price

schedules. ENL is continuing to monitor options on an appropriate mechanism to address the viability of having uneconomic lines.

The current approach to determining the best mix of options is to manage the risk and failures in a lowest cost manner.

#### **4.7.1.5 Performance Enhancement**

##### **Overhead to Underground Conversion**

ENL recognises that renewal of overhead lines with underground cables can provide benefits in the areas of public safety and reliability.

Projects of this nature are generally not considered due to funding constraints. However where growth projects are undertaken in urban areas, upgrades in conjunction with the undergrounding option are considered.

##### **Ground Fault Neutralisers**

An option exists to use Ground Fault Neutraliser technology, which reduces the amount of electrical arcing at the point a fault occurs on the network. This reduces the level of threat to human life and risk of fire. It also allows the power supply to be maintained to homes and businesses, while repair crews are dispatched to fix the fault. Transient or momentary faults can be neutralised as well, eliminating most cases of flickering lights and short term interruptions to power supply. The cost of establishing this technology is currently prohibitive given regulated revenue constraints.

##### **Urban/Rural Automation**

Previously ENL has invested in automation of approximately 80 key sites in the region to minimise disruption times to areas outside the immediate fault area. A small allocation of the Performance and improvement funding is allocated to increasing the level of automation over the life of this plan. Sites are selected that provide the greatest benefit after considering where faults are occurring and who is affected. As faults in the urban area are rare and response times in urban areas are low, rural automation projects are generally favoured over urban projects.

##### **Standby Distributed Generation**

In partnership with Eastland Generation Limited ENL has established sites used to enhance performance of the network in contingent events

and for maintenance activities. ENL is reviewing options to increase the level of distributed generation targeting vulnerable rural and remote lines that have performance issues identified from analysis of Distribution performance in section 8.2.4.

Areas include:

- Frasertown Raupunga
- Matawai
- Hicks Bay
- Rukaturi

### **Portable/Emergency Generation**

ENL uses small portable generators to supply customers during planned work and in emergencies. The use of the generators is dependent on criteria of availability, cost, assessed need, duration of need, and size of load. The emergency generator portfolio comprises 3 units as follows.

- 500kW Crane and Trucks (Currently not in service) Replacement options are being considered
- 200kW Truck mounted
- 60kW Trailer mounted (new 2011)

Additional units are being considered in the medium term. As the equipment is considered mobile plant funding is via existing allocation in the maintenance/operational budget. Currently service level improvements of this nature are a lower priority than inspection and maintenance activities associated with safety.

### **4.7.2 Development Co-ordination**

Capacity and security constraints impact different components of the transmission and distribution system and vary with growth expectations. Growth cannot be excluded at transmission level because it has the ability to outstrip the best laid development plans.

A high degree of co-ordination exists to implement approved transmission, sub-transmission and generation options so that investment is complimentary and supports the strategic objectives. Also it is preferable that development options are where possible

implemented incrementally so that adjustments can be made in response to changing circumstances.

### **4.7.3 Development program**

Expenditure forecasts based on the options considered for major initiatives are given below. The lack of significant development actions for major initiatives supports the minimal growth trends experienced and forecast in the region.

Year	Action	Cost
2012/2014	Mahia 2.5MW substation and 33kV Line extension	\$1,500,000
2012-2016	Wahi/AFFCO/Wairoa 33kV Supply & Rationalisation	\$3.0mill
2015-2017	Provisional Mangapapa Zone Substation 12.5MW	\$900,000
2017-2019	Provisional Whangara Zone Substation 2.5MW	\$950,000
2020-2025	Provisional Tuai – Gisborne 3 <sup>rd</sup> 110kV Line & new GXP Patutahi	\$65mill
2020-2025	Tuai – Gisborne 110kV Line Reconnector	\$10 - \$20mill
2019 - 2021	Provisional Patutahi Zone Substation Capacity increase 12.5MW	\$950,000
As needed	Provisional Embedded Generation, (Hydro, wind, biomass, gas)	\$100,000
As needed	Provisional Connection of Customer installed Generation	\$50,000

## 5. Managing the assets lifecycle

All physical assets have a lifecycle, and ENL's electricity assets are no exception. This section describes how ENL manages its assets over the entire lifecycle from "conception" to "burial".

### 5.1 What is the lifecycle of an asset

The lifecycle of an existing asset is outlined in Figure 5.1(a) below...

Figure 5.1(a) – Asset lifecycle

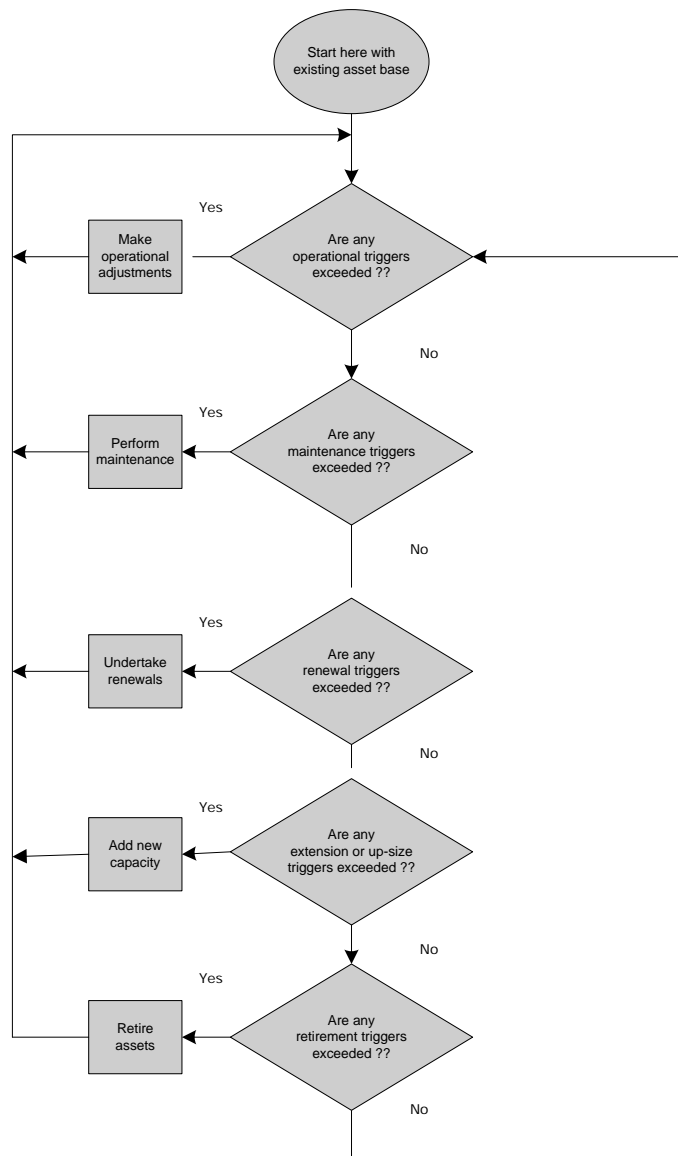

Table 5.1(b) below provides some definitions for key lifecycle activities...

**Table 5.1(b) – Definition of key lifecycle activities**

Activity	Detailed definition
Operations	Involves altering the operating parameters of an asset such as closing a switch or altering a voltage setting. Doesn't involve any physical change to the asset, simply a change to the assets configuration that it was designed for. In the case of electrical assets it will often involve doing nothing and just letting the electricity flow.
Maintenance	Involves replacing consumable components like the seals in a pump, the oil in a transformer or the contacts in a CB. Generally these components will be designed to wear out many times over the assets design lifecycle and continued operation of the asset will require such replacement. There may be a significant asymmetry associated with consumables such as lubricants in that replacing a lubricant may not significantly extend the life of an asset but not replacing a lubricant could significantly shorten the assets life.
Renewal	<p>Generally involves replacing a non-consumable item like a pole or transformer with a replacement item of identical functionality (e.g. strength, capacity). Such replacement is regarded as a significant mile-stone in the life of the asset and may significantly extend the life of the complete asset (e.g. the section of line and poles).</p> <p>Renewal also includes the replacement of components or items that no longer comply with initial design criteria, regulatory requirements or safety standards.(e.g. a rotten poles cannot support conductor design load, new regulatory standards for earthing, new safety requirements for switchgear operation)</p> <p>Renewal tends to dominate the CapEX in low growth areas (Quadrant 1 of Figure 4.1.2(b)) because assets will generally wear out before they become too small.</p> <p>The most typical criteria for renewal will be when the capitalised costs of ops and maintenance exceed the cost of renewal (including any loss of availability). Key issues with renewal are technological advances that generally make it impossible to replace assets such as SCADA with equivalent functionality, and creeping regulation that make certain assets (e.g. compressed air vessels over 100psi) unviable.</p>
Up-sizing	Generally involves replacing a non-consumable item like a conductor, busbar or transformer with a similar item of greater capacity but which does not increase the network footprint ie. restricted to Quadrants 1 and 2 in Figure 4.1.2(b).
Extensions	Involves building a new asset where none previously existed because a location trigger in Table 4.1.3(a) has been exceeded eg. building several spans of line to connect a new factory to an existing line. This activity falls within Quadrants 3 and 4 of Figure 4.1.2(b). Notwithstanding any surplus capacity in upstream assets, extensions will ultimately require up-sizing of upstream assets.

Retirement	Generally involves removing an asset from service and disposing of it. Typical guidelines for retirement will be when an asset is no longer required. Retirement can be considered “replacement with nothing”.
------------	--

## **5.2 Operating the assets**

As outlined in Table 5.1(b) operating the assets predominantly involves monitoring of the electricity flow from the GXPs to consumers’ premises with intervention when a trigger point is exceeded. Intervention usually involves carrying out or coordination of activities to reconfigure the asset in real time on a short or medium term basis to address the trigger point. As outlined in Figure 5.1(a) the first efforts to relieve excursions beyond trigger points are control room operational activities and may include...

- Operating a tap-changer to correct voltage excursions (which generally occurs automatically).
- Opening and closing ABS’s or RMU’s to relieve an over-loaded asset.
- Opening and closing ABS’s or RMU’s to shut down or restore power (which can be either planned or fault related).
- Operating load control plant to reduce demand.
- Activating fans or pumps on transformers to increase the cooling rate.
- Control electricity consumption or demand in accordance with the Security of supply outage plan.

### **5.3.1 Security of Supply Outage Plan**

The Security of supply outage plan has been produced to comply with the Electricity Commission requirements. The plan documents procedures for reducing demand or consumption in response to a shortage of generation or failures of the National Transmission Grid. In extreme events the plan documents priorities for disconnection of supply to consumers.

### **5.3.1 Operational Triggers**



Table 5.2(a) outlines the key operational triggers for each class of ENL's assets. Note that whilst temperature triggers will usually follow demand triggers, they may not always e.g. an overhead conductor joint might get hot because it is loose or rusty rather than overloaded.

**Table 5.2(a) – Operational triggers**

Asset category	Voltage trigger	Demand trigger	Temperature trigger
LV lines & cables	<ul style="list-style-type: none"> <li>• Voltage routinely drops too low to maintain at least 0.94pu at consumers switchboards.</li> <li>• Voltage routinely rises too high to maintain no more than 1.06pu at consumers switchboards.</li> </ul>	<ul style="list-style-type: none"> <li>• Consumers' pole or pillar fuse blows repeatedly.</li> </ul>	<ul style="list-style-type: none"> <li>• Signs of burning or melting.</li> </ul>
Distribution substations	<ul style="list-style-type: none"> <li>• Voltage routinely drops too low to maintain at least 0.94pu at consumers switchboards.</li> <li>• Voltage routinely rises too high to maintain no more than 1.06pu at consumers switchboards.</li> </ul>	<ul style="list-style-type: none"> <li>• Load routinely exceeds rating where MDIs are fitted.</li> <li>• LV fuse blows repeatedly.</li> <li>• Short term loading exceeds guidelines in IEC 354.</li> </ul>	<ul style="list-style-type: none"> <li>• Inspection reveals signs of heating</li> </ul>
Distribution lines & cables	<ul style="list-style-type: none"> <li>• Load flow analysis identifies sections in the danger zone, followed by verification from recorders</li> </ul>	<ul style="list-style-type: none"> <li>• Load flow analysis identifies sections in the danger zone, followed by verification from loggers.</li> <li>• SCADA set point alarms routinely triggered</li> </ul>	<ul style="list-style-type: none"> <li>• Joint fails or shows signs of heating</li> </ul>
Zone substations	<ul style="list-style-type: none"> <li>• Voltage drops below level at which SCADA set point alarms triggered.</li> </ul> <p>OLTC can automatically raise taps.</p>	<ul style="list-style-type: none"> <li>• Load exceeds guidelines in IEC 354.</li> </ul>	<ul style="list-style-type: none"> <li>• Top oil temperature exceeds manufacturers' recommendations.</li> <li>• Core hot-spot temperature exceeds manufacturers' recommendations.</li> <li>• Infra-red survey reveals hot joint</li> <li>• Gas analysis indicates burning in Transformers</li> </ul>
Sub-transmission lines & cables	<ul style="list-style-type: none"> <li>• Load flow analysis identifies sections in the danger zone, followed by verification from loggers.</li> <li>• SCADA set point alarms triggered</li> </ul>	<ul style="list-style-type: none"> <li>• Load flow analysis identifies sections in the danger zone, followed by verification from loggers.</li> <li>• Transpower alarms triggered</li> <li>• Analysis of GXP data shows excessive levels</li> </ul>	<ul style="list-style-type: none"> <li>• Infra-red survey reveals hot joint</li> <li>• Joint fails in service</li> </ul>

### 5.3 Maintaining the assets

As described in Table 5.1(b) maintenance is primarily about replacing consumable components. Examples of the way in which consumable components “wear out” include the oxidation or acidification of insulating oil, pitting or erosion of electrical contacts, and wearing of pump seals. Continued operation of such components will eventually lead to failure as indicated in Figure 5.3(a) below. Failure of such components is usually based on physical characteristics, and exactly what leads to failure may be a complex interaction of parameters such as quality of manufacture, quality of installation, age, operating hours, number of operations, loading cycle, ambient temperature, previous maintenance history and presence of contaminants – note that the horizontal axis in Figure 5.3(a) is not simply labelled “time”.

**Figure 5.3(a) – Component failure**

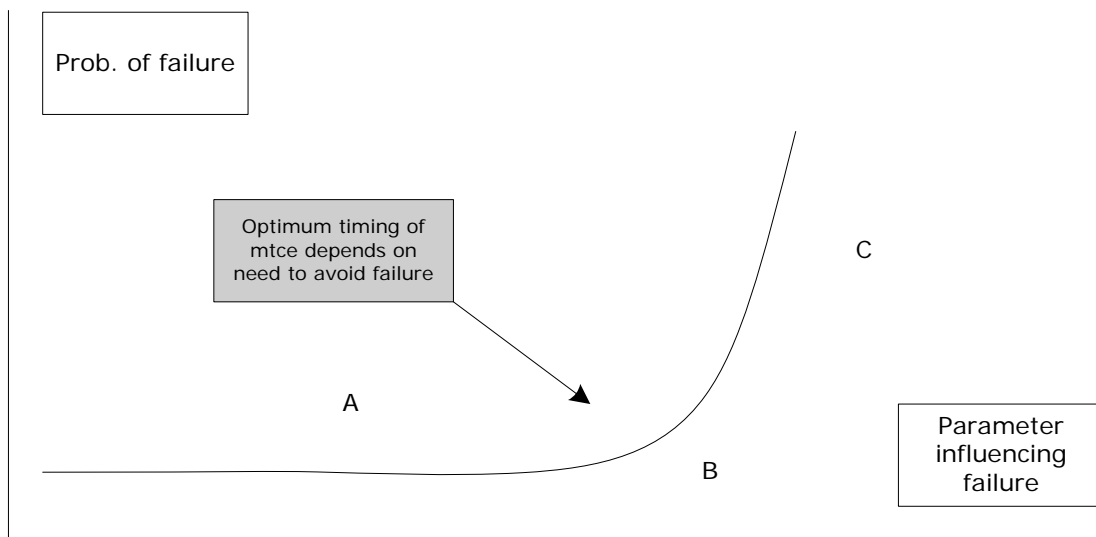

Exactly when maintenance is performed will be determined by the need to avoid failure. For instance the need to avoid failure of a 15kVA transformer supplying a single consumer is low, hence it might be operated out to point C in figure 5.3(a) whilst a 50/11kV substation transformer may only be operated to point B due to a higher need to avoid failure. In the extreme case of, say, turbine blades in an aircraft engine it would be desirable to avoid even the slightest probability of failure hence the blades may only be operated to point A. The obvious trade-off with avoiding failure is the increased cost of labour and

consumables over the assets lifecycle along with the cost of discarding unused component life.

Like all ENL's other business decisions, maintenance decisions are made on cost-benefit criteria with the principal benefit being avoiding supply interruption. The practical effect of this is that assets supplying large consumers or numbers of consumers will be extensively condition monitored to avoid supply interruption whilst assets supplying only a few consumers such as a 15kVA transformer will more than likely be run to breakdown. The maintenance strategy map in Figure 5.3(b) broadly identifies the maintenance strategy adopted for various ratios of costs and benefits.

**Figure 5.3(b) – Maintenance strategy map**

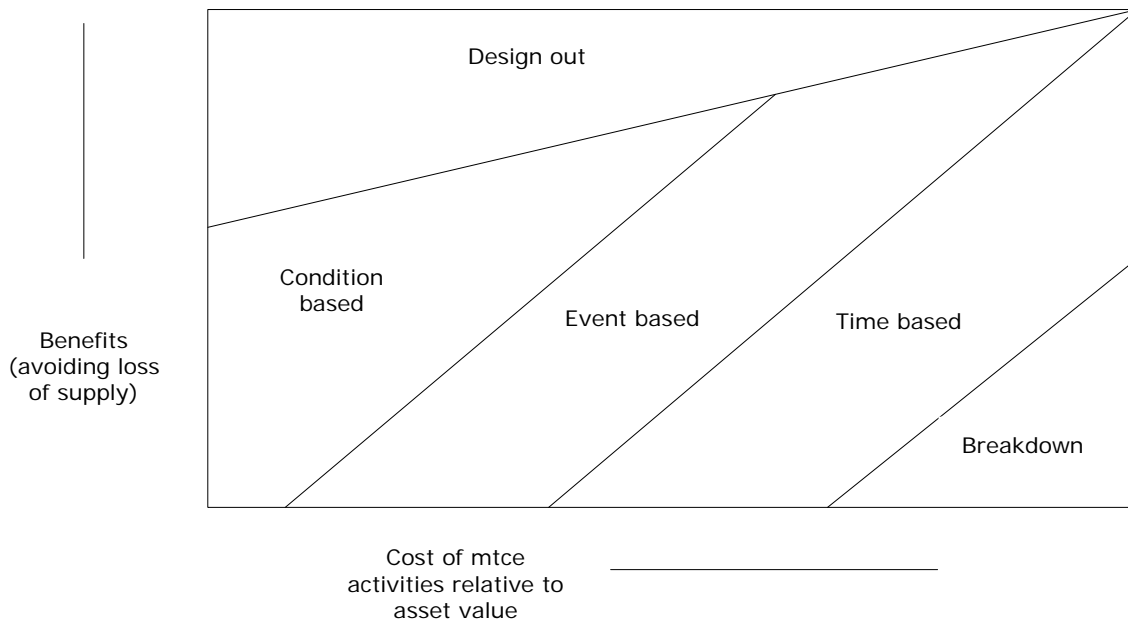

This map indicates that where the benefits are low (principally there is little need to avoid loss of supply) and the costs of maintenance are relatively high an asset should be run to breakdown. As the value of an asset and the need to avoid loss of supply both increase ENL relies less and less on easily observable proxies for actual condition (such as calendar age, running hours or number of trips) and more and more on actual component condition (through such means as DGA for transformer oil).

Component condition is the key trigger for maintenance. However the precise conditions that trigger maintenance are very broad, ranging from oil acidity to dry rot. Table 5.3(c) describes the maintenance triggers ENL has adopted...

**Table 5.3(c) – Maintenance triggers**

Asset category	Components	Maintenance trigger
LV lines & cables	Poles, arms, stays & bolts	<ul style="list-style-type: none"> <li>• Evidence of dry-rot or spalling.</li> <li>• Loose bolts, moving stays.</li> <li>• Displaced arms.</li> </ul>
	Pins, insulators & binders	<ul style="list-style-type: none"> <li>• Obviously loose pins.</li> <li>• Visibly chipped or broken insulators.</li> <li>• Visibly loose binder.</li> </ul>
	Conductor	<ul style="list-style-type: none"> <li>• Visibly splaying or broken conductor.</li> <li>• Poor clearances</li> <li>• Visibly Uneven sag</li> <li>• Trees in lines</li> </ul>
	Cable	<ul style="list-style-type: none"> <li>• Failure of insulation</li> </ul>
Service connections	Distribution Pillars	<ul style="list-style-type: none"> <li>• Visible Rust</li> <li>• Graffiti/Vandalism</li> <li>• Safety issues</li> </ul>
Distribution substations	Poles, arms & bolts	<ul style="list-style-type: none"> <li>• Evidence of dry-rot or spalling.</li> <li>• Loose bolts, moving stays.</li> <li>• Displaced arms.</li> </ul>
	Enclosures	<ul style="list-style-type: none"> <li>• Visible rust.</li> <li>• Cracked or broken masonry.</li> <li>• Overgrown access</li> <li>• Safety issues</li> <li>• Graffiti/Vandalism</li> </ul>
	Transformer	<ul style="list-style-type: none"> <li>• Excessive oil acidity (500kVA or greater).</li> <li>• Visible signs of oil leaks.</li> <li>• Excessive moisture in breather.</li> <li>• Visibly chipped or broken bushings..</li> <li>• Visible rust</li> <li>• Earthing issues</li> </ul>
	LV Switches & fuses	<ul style="list-style-type: none"> <li>• Build up of contaminants</li> <li>• Operations at recommended maintenance levels</li> <li>• Failure of fuse elements</li> </ul>
Distribution lines & cables	Poles, arms, stays & bolts	<ul style="list-style-type: none"> <li>• Evidence of dry-rot.</li> <li>• Loose bolts, moving stays.</li> <li>• Displaced arms.</li> </ul>
	Cables	<ul style="list-style-type: none"> <li>• Failure of insulation</li> <li>• Oil leaks</li> </ul>
	Pins, insulators & binders	<ul style="list-style-type: none"> <li>• Obviously loose pins.</li> <li>• Visibly chipped or broken insulators.</li> <li>• Visibly loose binder.</li> </ul>

		<ul style="list-style-type: none"> <li>• Radio interference</li> </ul>
	Conductor	<ul style="list-style-type: none"> <li>• Visibly splaying or broken conductor.</li> <li>• Poor clearances</li> <li>• Signs of clashing</li> <li>• Visibly Uneven sag</li> <li>• Trees in lines</li> </ul>
Distribution Switchgear	Ground-mounted switches	<ul style="list-style-type: none"> <li>• Detectable discharge</li> <li>• Detectable hot spots</li> <li>• Buildup of contaminants</li> <li>• Oil/Gas leaks</li> <li>• Visible Rust</li> <li>• Graffiti/Vandalism</li> </ul>
	Fuses ABS's, Switches	<ul style="list-style-type: none"> <li>• Loose mechanisms</li> <li>• Earthing issues</li> <li>• Visibly burnt contacts</li> <li>• Oil/Gas leaks</li> <li>• Corrosion</li> </ul>
Voltage Regulators	Transformer	<ul style="list-style-type: none"> <li>• Excessive oil acidity (500kVA or greater).</li> <li>• Visible signs of oil leaks.</li> <li>• Excessive moisture in breather.</li> <li>• Visibly chipped or broken bushings..</li> <li>• Visible rust</li> <li>• Binding mechanisms</li> </ul>
	Control Equipment	<ul style="list-style-type: none"> <li>• Inaccurate readings</li> <li>• Miss operation</li> </ul>
Zone substations	Fences & enclosures	<ul style="list-style-type: none"> <li>• Visible damage</li> <li>• Visible rust</li> <li>• Leaks</li> <li>• Safety issues</li> </ul>
	Buildings	<ul style="list-style-type: none"> <li>• Visible damage</li> <li>• Leaks</li> <li>• Visible deterioration</li> <li>• Backed up pipes</li> <li>• Leaking taps</li> <li>• Visible Rot</li> <li>• Broken fittings</li> </ul>
	Bus work & conductors	<ul style="list-style-type: none"> <li>• Visibly splaying or broken conductor.</li> <li>• Poor clearances</li> <li>• Signs of clashing Visibly Uneven sag</li> <li>• Trees in lines</li> <li>•</li> </ul>
	33kV/50kV switchgear	<ul style="list-style-type: none"> <li>• Detectable discharge</li> <li>• Detectable hot spots</li> <li>• Failure to operate</li> <li>• Operations at recommended maintenance levels</li> </ul>
	Transformer	<ul style="list-style-type: none"> <li>• Excessive oil acidity</li> <li>• Visible signs of oil leaks.</li> <li>• Excessive moisture</li> <li>• Visibly chipped or broken bushings..</li> <li>• Visible rust</li> <li>• Excessive noise</li> <li>• Excessive gas content</li> </ul>

	11kV switchgear	<ul style="list-style-type: none"> <li>• Detectable discharge</li> <li>• Detectable hot spots</li> <li>• Failure to operate</li> <li>• Operations at recommended maintenance levels</li> </ul>
	Instrumentation	<ul style="list-style-type: none"> <li>• Unreadable</li> <li>• Inaccurate readings</li> <li>• Miss operation</li> </ul>
	Poles, arms, stays & bolts	<ul style="list-style-type: none"> <li>• Evidence of dry-rot or spalling.</li> <li>• Loose bolts, moving stays.</li> <li>• Displaced arms.</li> </ul>
Sub-transmission lines & cables	Pins, insulators & binders	<ul style="list-style-type: none"> <li>• Obviously loose pins.</li> <li>• Visibly chipped or broken insulators.</li> <li>• Visibly loose binder.</li> <li>• Radio interference</li> </ul>
	Conductor	<ul style="list-style-type: none"> <li>• Visibly splaying or broken conductor.</li> <li>• Poor clearances</li> <li>• Signs of clashing</li> <li>• Visibly Uneven sag</li> <li>• Trees in lines</li> </ul>
	Radios and repeaters	<ul style="list-style-type: none"> <li>• Communications fade or unavailability over limits</li> <li>• Levels out of allowable limits</li> <li>• Frequencies out of range</li> </ul>
Communications	Radios	<ul style="list-style-type: none"> <li>• Non operational</li> <li>• Loss of signal</li> <li>• Levels out of allowable limits</li> </ul>
SCADA	RTU's	<ul style="list-style-type: none"> <li>• Loss of data</li> <li>• False indication occurs</li> <li>• Fails to indicate</li> <li>• Measurements suspected as being out of valid range</li> <li>• Equipment Lockup Controls fail to function</li> <li>• Miss operation</li> <li>• Nuisance alarms</li> </ul>

## Maintenance Activities

The following maintenance sub sections of the lifecycle management plan describe details of the regular on-going work that is necessary to keep assets operating to their minimum design levels, maintain the assets to an acceptable condition (e.g.no graffiti) and ensure the assets are performing safely. The details include the basis for condition monitoring, equipment standards, planned activities and provisions for unplanned actions in response to faults or incidents. Condition monitoring activities have been developed that are appropriate for each type of asset. These are presented by individual asset category using the same nomenclature as the CapEx plans. Maintenance inspection and testing work relating to safety is generally based on regular time intervals and for condition assessment the time interval

period varies over the life of the asset. Other maintenance activities are driven from condition and reliability monitoring.

**Maintenance Management Process**

During annual planning budgeted activities identified for each asset category are time lined for completion over the year to optimise resources. The Asset management team members are allocated the activities to complete. The works management system is used to manage the contracts for the maintenance activities. Paper based systems are used to obtain the information relating to asset condition and maintenance completed. Pertinent details relating to condition and maintenance undertaken are entered into the GIS system for reporting. Schedules of defects and corrective actions are prepared from the field returns and fed back into the works management system and dispatched to field contractors for correction. Separation of the GIS and Works database entry/reporting functions, ensure that all required condition assessments are obtained and the defects identified are rectified. Field audits and periodic changes to the allocation of activities to both Asset management and field staff ensure the maintenance procedures and activities are being carried out correctly.

**5.3.1 Fault Management**

All fault response work is contracted to two service providers. Firstly the provision of 24 hr x 7 day call centre services is currently contracted to a company based in Hastings. The scope of this contract includes the receiving of fault calls from customers and energy retailers and the direct dispatch of fault response resources.

A second contract for the provision of field resources for fault restoration and minor repairs is currently held by Eastech Limited which in order to service the contract has resources located in Wairoa, Gisborne, Tolaga Bay and Tokomaru Bay. As specified in the contract any renewal required following the initial fault response is determined as maintenance or capital in accordance with ENL accounting policies.

The annual Fault Management cost of \$273,352 associated with these contracts is allocated, (in proportion to the faults forecast by extrapolation of historical trends), across asset classes as follows;

50kV Lines	\$ 20,000
11kV Lines & Cables	\$212,600
400V Lines & Cables	\$ 19,000
Load Control	\$ 4,000



Zone Substations	\$ 6,000
Transformers (Distribution)	\$ 6,010
11kV GM Switches	\$ 4,242
Pole Mounted Isolation Equip	\$ 1,500

The annual Fault Management cost includes costs of the third party call centre.

### **5.3.2 Sub-transmission lines**

A visual patrol of every urban 50 and 33 kV pole and the conductors is carried out every twelve months. A helicopter patrol of every rural 50 and 33 kV line is carried out every twelve months. The patrols are often incorporated into the patrols necessary as a result of a fault occurring. The following points are included in the inspection:

- Structure foundation erosion (weather or excavator work)
- Structure movement and conductor clearance
- General hardware, insulator and conductor condition
- Early signs of cross-arm burning
- Damaged or broken binders
- Monitor vibration dampener performance
- External interference (e.g. trees)
- Sabotage

A more detailed inspection is carried out on 50 & 33 kV poles at an increasing frequency as the lines near their forecast end of life. This inspection includes updating safety index information on the poles through pole testing and/or visual inspection techniques. Visual inspection includes excavation and/or climbing to categorically determine the poles below ground and/or head condition. Any components on the poles, identified from the inspections that require renewal are categorised in terms of risk and scheduled for correction within 1 year.

Discharge detection and thermo scans of selected areas of line close to terminal points at zone substations are undertaken 3 yearly, corresponding with the checks at zone substations. Repairs required as a result of the scans are categorised in terms of risk and scheduled for correction within 1 year.

#### Pole Assessment Criteria

Every pole has a safety index record which rates the poles current strength capabilities against the required pole strength. This information is held in database. The safety indices for wooden poles are updated following inspection and qualified where necessary by ultrasound scan tests.

Poles with a safety index less than 1.5 are red tagged to signify that the pole could fail under normal loads. The targeted replacement of red tagged poles is 3 months.

Poles where the safety index has declined to between 1.5 and 2.5 are identified with a blue tag which signifies that the pole is capable of supporting normal loads but not design loads. The targeted replacement of blue tagged poles located in populated areas or other risk areas is within 12 months. Other blue tagged poles are targeted to be replaced within 2 years.

Poles with a safety index of 2.5 and above have repeat visual inspections and testing every 5 years to determine remaining strength.

Note concrete poles only require a visual inspection per the above as below ground and head rot does not occur. Visual inspection identifies at risk poles.

The pole inspection and testing regime used to assess sub-transmission lines, is also used to assess and rate 11kV and 400V distribution poles.

Standards

Various standards used include the following:

- AS/NZS 4056 and 4676 for concrete poles,
- AS 2209 for wooden poles.
- Specific standards for conductors, line hardware and fittings.

<b>Planned Actions</b>	<b>Total</b>	<b>Quantity</b>	<b>Unit Cost</b>
Patrols (Ground & Helicopter)	\$24,000	2000	\$12
Inspection	\$20,000	135	\$150

Testing of Poles	\$10,000	200	\$ 50
Component Renewal/Maint	\$50,000	50	\$ 1000

**Unplanned Actions**

Tree control (refer 11kV Lines and Cables)	N/A
Defect / Fault repairs	\$12,500
Fault response (incl. Helicopter)	\$20,000
Radio Interference correction	\$6,000

**5.3.3 11kV lines and cables**

A visual patrol of every pole and its associated line hardware and conductors is carried out at a maximum interval of two years. Poles and lines located in urban areas and rural townships are inspected every twelve months. The patrols are often incorporated into the patrols necessary as a result of a fault occurring.

A more detailed inspection is carried out every five years as the lines near their end of life. This inspection includes updating safety index information on the poles through pole testing/inspection techniques. Visual inspection includes excavation and/or climbing as necessary to categorically determine the poles below ground and/or head condition. Any components on the poles, identified from the inspections that require replacing are categorised in terms of risk and scheduled for correction within 1 year. Renewal of partial pole components e.g. cross-arms is not capitalised.

As with sub-transmission poles the mechanical strength requirements for all individual 11kV poles have been determined and recorded. The safety indices for wooden poles are updated as a result of inspection and where necessary ultrasound scan tests.

At risk poles are identified from the inspection returns and updated in pole database records, using the same criteria as for sub-transmission poles. Replacement and monitoring strategies are as per the Pole Assessment in Sub-transmission Lines section.

Note concrete poles only require a visual inspection per the above as below ground rot does not occur.

A tree control program consisting of hazard identification and notification in accordance with the Electricity (Hazards from Trees) Regulations 2003 has been developed. Elements of this program include...

- Patrolling of the network to identify and record tree interference/hazards. These patrols are undertaken on 12-18 month cycles.
- The identification of tree owners whose trees are a hazard and the issuing of Hazard Warning Notices or Cut/Trim Notices and subsequent negotiations.
- The engagement of accredited contractors to undertake ENL funded first cuts and/or the removal of "no interest" trees.
- In 2010 a specific program to target tree control associated with commercial forestry blocks was commenced. The program is expected to eliminate the associated hazards over the next 3 years.

No planned cable maintenance activities are deployed. Replacement is programmed in capital works budget from analysis of performance from fault statistics.

Due to the unavailability in the market of insurance cover for significant events affecting distribution network assets, ENL has in place;

- Storm/significant event contingency funding of at \$100,000 per year
- A \$1.0mill borrowing provision reserved in its annual funding plan.

Transformers, Switches and line sections that become surplus to requirements through changes to land use and load are identified during patrols and reporting systems. Specific funding is allocated to the removal of this unnecessary equipment.

### Standards

Various standards used include the following:

- AS/NZS 4056 and 4676 for concrete poles.
- AS 2209 for wooden poles.

- Various specific standards for conductors, line hardware, fittings and cable types.

<b>Planned Actions</b>	<b>Total</b>	<b>Quantity</b>	<b>Unit Cost</b>
Patrols and General maintenance	\$200,000	40feeders	\$5000
Pole Inspection and testing	\$80,000	1600	\$50
Tree control program	\$600,000	1200	\$500
Forestry Tree control program	\$200,000	10	\$20000
Equipment Removal	\$40,000		

<b>Unplanned Actions</b>	<b>Total</b>	<b>Quantity</b>	<b>Unit Cost</b>
Defect / Fault repairs	\$210,000		
Fault response	\$120,000	120	\$1000
Control and Switching costs	\$20,000		
Trees forced cutting	\$100,000	250	\$400
Storm contingency	\$100,000		

### **5.3.4 LV lines and cables**

A visual patrol of every pole and the conductors is carried out at a maximum interval of two years. Poles and lines located in urban areas and rural townships are inspected every twelve months. Should any mechanical strength defects be discovered then a full below ground inspection will be done within a year.

Safety indices for all 400V wooden poles are known and recorded. These are updated via visual inspections, on a five yearly basis, qualified where necessary by pole testing/inspection techniques.

At risk poles are identified from the pole database records and using the same safety index criteria as for sub-transmission and distribution poles. Replacement and monitoring strategies are as per the Pole Assessment in Sub-transmission Lines section.

Note concrete poles only require a visual inspection per the above as below ground and head rot does not occur.

Tree patrols, notification and cutting are undertaken in conjunction with the 11kV Tree Control program.

No planned cable maintenance activities are deployed. Replacement is programmed in capital works budget from analysis of performance from fault statistics.

Standards

Various standards used include the following:

- AS/NZS 4056 and 4676 for concrete poles.
- AS 2209 for wooden poles.
- Various specific standards for conductors, line hardware and fittings.
- Various standards for cable types used.

<b>Planned Actions</b>	<b>Total</b>	<b>Quantity</b>	<b>Unit Cost</b>
Patrols and minor maintenance	\$10,000	50km	\$200
Pole Inspection/Testing	\$15,000	300	\$50
General Maintenance cable	\$10,000		
Tree control Program	Refer 11kV		
<b>Unplanned Actions</b>	<b>Total</b>	<b>Quantity</b>	<b>Unit Cost</b>
Trees forced cutting		Refer 11kV	
Defect / Fault repairs	\$ 50,000		
Fault response	\$ 25,000	100	\$250

**5.3.5 Service connections**

Service connections are inspected visually every five years. Where the inspection identifies problems liaison is directly with service connection owner. The repairs of the defects are the responsibility of the service connection owner within six months. In cases of high safety risk and no action by the service connection owner the service connection may be disconnected.

Inspection of private HV service connections every 5 years is the responsibility of the private owner. However problems identified during visual patrols covered in the 11kV lines section are notified to the private owner for correction within 6 months.

Compliance with Voltage levels is monitored via voltage checks. This includes the investigation of customer reported quality of supply issues. Costs associated with the rectification of customer supply issues are allocated against the assets involved.

<b>Planned Actions</b>	<b>Total</b>	<b>Quantity</b>	<b>Unit Cost</b>
Patrols/inspection	\$ 5,000	500	\$10
<b>Unplanned Actions</b>	<b>Total</b>	<b>Quantity</b>	<b>Unit Cost</b>
Voltage Checks/Complaints	\$20,000	100	\$200

**5.3.6 Load Control**

The Load control injection plant and coupling cells are tested and inspected each year prior to the main winter load period. Controllable load is updated prior to the main winter load period. Any defects found are repaired immediately

Standards

Injection equipment is maintained within the Manufacturers specifications for the operating frequency and voltage levels.

<b>Planned Actions</b>	<b>Total</b>	<b>Quantity</b>	<b>Unit Cost</b>
Injection plant testing	\$8,000	2	\$4000
<b>Unplanned Actions</b>	<b>Total</b>	<b>Quantity</b>	<b>Unit Cost</b>
Defect repairs / replacement costs (Excludes capital relay costs)	\$5,000		
Fault response (Pilot circuits)	\$5,000	20	\$250

**5.3.7 Zone Substations**

Each Zone Substation is inspected every four months and includes inspection and minor maintenance activities associated with...

- Transformers
- Circuit breakers
- Switchgear including connections or terminations

- Protection and control equipment
- Scada and communications systems
- Structures, insulators and bus work
- Overhead line connections
- Voltage regulators
- Zone substation LV switchboards
- DC switchboards and battery systems
- Earthing systems
- Buildings
- Fences
- Oil containment
- Pest control measures
- Drainage
- Emergency and contingency systems
- Signage and Safety Systems

Safety equipment inspection and testing at each zone substation is undertaken annually. Also an independent Occupational Health and Safety inspection of each zone substation is made annually.

Thermo-vision and ultrasound scans are carried out three yearly at zone substations. The earthing system resistance at each zone substation is tested every five years. All urgent defects are repaired on discovery, major non urgent defects are repaired within four months, and other minor defects will be included in the normal maintenance program.

Time based maintenance schedules are maintained for equipment at each zone substation. These schedules are modified following evaluation of inspection and condition assessment results. The typical frequencies range from 2 to 5 years. The lower 2 yearly frequencies are largely due to older equipment. Required equipment maintenance based on usage recordings, inspection and condition monitoring is then carried out. The summary below shows the average annual costs for routine adjustment, testing, calibration and preventative maintenance of the zone substation and rural voltage regulator equipment.

Routine Maintenance Summary

Voltage Regulators	\$3,000
TeAraroa Sub	\$5,000
Ruatoria	\$5,000
Tokomaru bay	\$3,000
Tolaga Bay	\$4,000



Kaiti	\$4,000
Carnarvon Street	\$4,000
Port	\$2,000
Valley Rd	\$ 500
Parkinson Street	\$3,000
Matawhero	\$3,000
Makaraka	\$3,000
Patutahi	\$4,000
Puha	\$3,000
Ngatapa	\$4,000
Pehiri	\$4,000
Hexton	\$1,250
Goodwin Rd	\$1,250
Wairoa Substation	\$2,000
Kiwi Substation	\$4,000
Blacks Pad	\$1,000
Tahaenui	<u>\$1,000</u>
TOTAL	\$65,000

## Standards

Environmental standards for noise control and oil contamination levels are maintained within council specifications. Zone substations are maintained within the requirements of Health and Safety, Electricity, Environmental and Building acts, regulations and codes of practice.

<b>Planned Actions</b>	<b>Unit</b>	<b>Total</b>
3 Monthly Inspections (25 sites 3 Visits p.a.)		\$25,000
Grounds Maintenance (20 sites 12 visits p.a.)	\$125	\$35,000
OHS inspection (20 sites)	\$250	\$5,000
Thermo or ultrasound inspections (20 sites)	\$250	\$5,000
Average Routine Maintenance		\$65,000

<b>Unplanned Actions</b>	<b>Total</b>
Defect / Fault repairs	\$25,000
Fault response	\$4,000

Note - work associated with circuit breakers, switching equipment, control/SCADA and protection equipment and LV / DC Systems at zone substations has been included.

### 5.3.8 Zone Substation Transformers

Activities include...

- Bi-annual DGA analysis
- Bi-annual Furans analysis
- Thermo vision as part of substation maintenance
- Painting as required
- Tap changer oil flushing
- Tap changer overhaul per manufacturer's recommendations
- Process oil as required
- Major overhaul as required

Note - major overhauls are not undertaken on aged single phase banks. Replacement with a new 3 phase transformer is more economic.

#### Standards

Based on BS 148, IEC 42 and Transpower standards.

- Oil acidity < 0.1 mgkOH/g
- Oil electrical strength > 40kV
- Moisture content < 30 ppm
- Resistivity 20 deg  $\geq 60$  G ohms per metre
- Dissolved gas limits
 

-Hydrogen	50 ppm
-Methane	50 ppm
-Carbon Monoxide	300 ppm
-Carbon Dioxide	3000 ppm
-Ethylene	100 ppm
-Ethane	100 ppm
-Acetylene	15 ppm

While standards concentrate on maintaining oil condition it is important not to confuse this with transformer condition. These standards must be maintained in order for the transformer to achieve standard life. Exceeding the standards results in permanent damage and shortening of transformer life. DGA analysis provides indication of

developing faults and the need for internal maintenance. Trends are monitored to assess expected life/aging.

Recent asset condition surveys have revealed the premature failure of the protective coating systems on zone transformers. This has resulted in significant steel corrosion. Accordingly allowance is made from 2008 to repaint 1 zone per year using high specification products. The repaints are forecast to last a minimum of fifteen years.

Specific earthquake restraint designs are provided for the transformer installations.

Planned Actions

Transformer painting	\$20,000
DGA furrow tests,	\$11,440
Average tap changer overhauls	\$15,000
Average oil processing	\$12,000

**5.3.9 Circuit breakers**

Substation circuit breakers are inspected visually during four monthly substation inspections. Two yearly thermovision surveys include all substation circuit breakers. Trip testing is carried out in conjunction with protection testing. Partial discharge testing is carried out on indoor circuit breakers. The frequency of the testing cycle increases as discharge levels increase over time. This work is covered in the zone substations section. This is the main indicator of CB insulation condition and therefore CB life.

Inspection and maintenance of rural pole mounted circuit breakers and remote controlled switches is carried out yearly.

Di/dt circuit breaker wear monitoring is implemented where protection equipment has this capability. The information is recorded and assessed as part of the Zone substation inspection work.

The number of trip operations is monitored via SCADA or as part of the 3 monthly / annual inspections. Remote or field circuit breakers are inspected annually and trip testing is carried out at intervals not exceeding 3 years. Minor and major maintenance assessments are used to determine end of life and replacement triggers. Work under taken during these activities generally includes:

- Oil replacement
- Adjustment of travel and mechanisms
- Mechanism lubrication
- Contact replacement if required
- Cleaning, painting
- Trip testing, timing
- Re-insulation, replacement of damaged or worn components.

Variation of discharge or thermo vision results from previous results triggers major maintenance of the circuit breakers

Standards

- AS/NZS 2650 Common specifications for HV switchgear.
- Manufactures specifications for each type of equipment.
- Transpower standards and recommendations for minor and major maintenance frequencies derived from industry experience.
- Oil circuit breakers servicing.
  - 50kV      CB's after 2 fault trips or 8 years
  - 11kV      CB's after 8 fault trips or 8 years

<b>Planned Actions</b>	<b>Total</b>	<b>Quantity</b>	<b>Cost</b>
Rural Automation annual inspection	\$13,500	90	\$150
Rural Automation/CB avg routine maint	\$18,000	45	\$400

<b>Unplanned Actions</b>	<b>Total</b>
Defect /Fault repairs	\$20,000

Note - work associated with circuit breakers at zone substations is included in the zone substations section.

**5.3.10 Distribution Transformers**

Smaller transformers generally in rural locations are inspected in conjunction with earth testing programs and line inspections. Transformers with an installed age over 35 years are specifically checked to identify units with excessive external deterioration of the tanks or 11kV tails where they are internally connected, for replacement.

In all cases the units are checked during earth testing/switchgear inspections at intervals not exceeding 5 years. Oil testing is carried out on transformers 500kVA and above the frequency of the tests varies depending on the analysis results.

Ground mount substations undergo an annual visual inspection. Items covered in the inspection include inspection of the LV panels, associated 11kV switchgear, Load readings, high voltage terminations, earthing, warning/danger notices and security equipment, (i.e. door locks and equipment covers).

General maintenance activities carried out in conjunction with inspections include painting on site, vegetation/rubbish clearing, LV panel cleaning and label upgrading.

Transformer loading on ground mount substations is monitored annually via MDI readings. Low voltage panels of all Ground style substations over 100kVA are inspected annually MDI readings are recorded.

Other than 5 yearly earth testing and inspections during the course of line patrols no maintenance activities are carried out on smaller in-service transformers.

Transformers returned from the field for service, receive minor refurbishment work where the age of the units is less than 20 years old.

Earth testing is carried out on a 5 year cycle. Earths include distribution substations, switch sites and LV earths. Earthing system repairs are undertaken on the worst 20% of earth tests. Earth tests between 0 and 50 ohms are considered adequate in terms of the expected seasonal variation in ground moisture content.

Standards

Refurbishment is only considered if the transformer condition is such that it has 15 years remaining service life and cost is less than 25% of a new transformer. Economics is limited by the frequency of relatively expensive recovery and installation.

<b>Planned Actions</b>	<b>Quantity</b>	<b>Unit Cost</b>	<b>Total</b>
Refurbishment <100kVA	10	\$ 500	\$5,000

Refurbishment >100kVA	2	\$4,000	\$8,000
Inspection and minor maint	528	\$ 50	\$25,000
Oil Handling /filtering /TX disposal			\$10,000
Earth testing	1000	\$25	\$25,000
Earthing system repairs	100	\$450	\$45,000
<b>Unplanned Actions</b>	<b>Total</b>		
Defect /Fault repairs		\$15,000	

**5.3.11 Pole Mounted Isolation Equipment**

Inspection of all air break switches is carried out in conjunction with Zone substation inspections, line patrols and prior to operation. Visual inspection includes checking of the switch contacts and mechanism. Inspection and testing of the earthing is carried out as per earth testing described in the Transformer section.

Operational testing of the switches is carried out where this is possible without a shut-down. Live line methods are deployed to carry out maintenance on switches where necessary. Defects are documented as found and corrective action prioritised as necessary to prevent failure in service. This may involve nil operation until the opportunity to coordinate with other work.

Standards

- Equipment maintained in accordance with Manufacturers specifications.

Costs associated with maintenance activities are included within the other asset categories. i.e. Zone substations, CB maintenance, line maintenance.

**5.3.12 11kV Switchgear (ground mounted)**

Ring main units, oil filled isolators, fuse units and SF6 units are inspected yearly. Items covered in the inspection include inspection of cable entry/protection, operating components, earthing,

warning/danger notices and security equipment, (i.e. covers and locks).

General maintenance activities carried out in conjunction with inspections include painting on site, vegetation/rubbish clearing, LV panel cleaning, label upgrading and lubrication of operating components.

Maintenance requiring a shutdown is carried out at increasing intervals as the equipment nears end of life.

At key sites and larger industrial substations switchgear is surveyed bi-annually using thermo-vision equipment. The survey attempts to provide early warning of poor or failing connections to the switchgear and poor contacts. The frequency of monitoring will be increased if testing identifies problems developing at a higher rate.

Partial Discharge monitoring is also carried out on larger switchboards at intervals not exceeding 5 years where proximity to transformers does not cause interference. The frequency of monitoring will be increased if testing identifies problems developing at a higher rate.

### Standards

- Oil leaks and low oil levels are repaired within 6 months.
- Rust is treated within 12 months.

### Maintenance activities

For RTE switches maintenance is carried out in conjunction with refurbishment of the transformers when they are removed from service.

Routine maintenance work requiring shut downs is opportunistic. This is a major constraint on the level of confidence that can be applied to equipment reliability.

Servicing is carried out on the basis of the inspection results. Activities include:

- Exterior painting on site
- Oil replacement
- Contact replacement
- Termination inspections and cleaning where possible
- Termination replacement

<b>Planned Actions</b>	<b>Total</b>	<b>Quantity</b>	<b>Unit Cost</b>
Inspection and minor maint	\$10,000	194	\$50
Average Switch maintenance p.a.	\$15,000	15	\$1,000
Substation Building Maint/repairs	\$10,000	5 p.a.	\$2000
<b>Unplanned Actions</b>	<b>Total</b>	<b>Quantity</b>	<b>Unit Cost</b>
Defect /Fault repairs	\$10,000	5	\$2000

### 5.3.13 LV switchgear

A general inspection of LV switchgear is incorporated into annual line patrols. A specific visual patrol of LV Disconnection and Link boxes is carried out every 5 years and larger link boxes are checked and cleaned during 3 yearly inspections. LV frames in ground mount substations are inspected in conjunction with annual transformer Inspections. No routine maintenance activities are undertaken on overhead LV equipment.

#### Standards

Legal compliance and pre-emption of faults.

<b>Planned Actions</b>	<b>Total</b>	<b>Quantity</b>	<b>Unit Cost</b>
Inspections/servicing	\$15,000	500	\$30
Inspections/servicing Shared Boxes	\$ 5,000	150	\$33
OH Fusebase and Carrier Replacement	\$50,000	250	\$200
<b>Unplanned Actions</b>	<b>Total</b>	<b>Quantity</b>	<b>Unit Cost</b>
Defect /Fault repairs	\$ 10,000		

### 5.3.14 Control and protection

Operation of the equipment is monitored via the SCADA system all operation events are investigated to ensure the operation of devices occurred correctly. Incorrect operation of protection has been found to occur with some equipment types typically in relation to auto-reclose controls. Relay testing and CB trip testing frequencies for relays vary



depending on the type and age of devices. The functionality of the tap-changers is monitored via the SCADA system.

Battery maintenance costs are minimal tests and maintenance on batteries within zone substations are included in 4 monthly zone substation inspections. No maintenance is carried out at rural automation sites as the cost to replace the batteries is lower than the cost to undertake tests.

#### Standards

- Within manufactures specs for individual relays and equipment.
- Where liquid batteries are contained within buildings separate rooms are used with good ventilation. Where this cannot be achieved batteries are housed in outdoor containers.

#### Maintenance activities

- Tap change control – Adjustment and calibration of AVR's not exceeding 4 yearly
- Transducers – calibration 6 yearly
- 24V battery systems – First test 2 years after initial installation, thereafter annual Load test on 24V battery systems
- 110V battery systems – Annual physical inspection and load test (monitoring on line)
- Protection Electromechanical – Three yearly secondary tests
- Protection Solid-state – 5 yearly secondary tests
- Protection Microprocessor – 10 yearly tests
- CB trip testing – Not exceeding 5 yearly when no operation has occurred. (refer Circuit Breaker maintenance)
- Transformer protection not exceeding 10 yearly
- Fire safety and intruder systems not exceeding 6 monthly

Note - work associated with protection and control equipment is included in the related asset section/budget.

#### **5.3.15 Communications**

A degree of remote monitoring of the radio systems is in place to provide early warning of equipment malfunction. Annual testing and calibration is carried out to ensure the equipment performance is within specification.

#### Standards

- Complies with the Radio Spectrum Management Conditions and Radio Communication Regulations.
- Operates within manufacturers specifications.
- Power - repeaters – 25W, RTs – 5W.
- Drift - no more than 2 kHz.
- Frequency.
- Heat levels within manufacturers specifications.
- One complete spare link and 2 portable repeaters are maintained for contingency operations.

<b>Planned Actions</b>	<b>Total</b>
Maintenance/Calibration	\$35,000
Track Maintenance	\$4,000
Hut Maintenance	\$4,000
Radio Licences	\$13,000

**Unplanned Actions**

Defect/Fault repairs	\$16,000
----------------------	----------

**5.3.16 SCADA**

In general the RTU input and output functions are tested in conjunction with maintenance of the associated equipment. During protection and switchgear testing the digital indications, analogs, measurement and control functions are verified back to the master station. General indications such as door security and fire alarms are verified during 3 monthly inspections.

Other indications such as DC battery and mains fail alarms are verified during RTU inspections at intervals not exceeding 2 years. This work is generally coordinated with other activities being undertaken at the substations.

Standards

- Operates within manufacturers specifications

<b>Planned Actions</b>	<b>Total</b>
Support fees	\$10,000
Software Licences	\$5,000
SCADA maintenance allowance	\$10,000
Configuration file alterations	\$6,000

#### **Unplanned Actions**

Defect/Fault repairs	\$10,000
----------------------	----------

### **5.4 Renewing assets**

In accordance with Information Disclosure (2008) capital expenditure categories ENL classifies work as renewal when an asset is replaced due to physical deterioration of the asset or as a result of the obsolescence of the asset. The key criteria for renewing an asset is when the capitalised operational and/or maintenance costs exceed the renewal cost .This can occur in a number of ways...

- Operating costs become excessive e.g. Addition of inputs to a SCADA system requires an increasing level of manning.
- Maintenance costs begin to accelerate away. E.g. a transformer needs more frequent oil changes as the seals and gaskets perish.
- Supply interruptions due to component failure become excessive (and what constitutes "excessive" will be a matter of judgment which will include the number and nature of customers affected).
- Renewal costs decline, particularly where costs of new technologies for assets like SCADA decrease by several fold.
- The asset does not comply with design, regulatory or safety requirements.

Because of the low growth and surplus capacity in the network, ENL capital expenditure is dominated by renewals. The rate of renewal can be used to manipulate the age of each asset category relative to its rate of depreciation. Most of ENL's asset categories are being renewed

at a rate less than the depreciation but commensurate with constrained revenue, hence the overall asset is aging.

While the renewal rate manipulates the age of the population for each asset category, the historical population age profile and condition assessment information provide sufficiently accurate forecast renewal rates. The forecast renewal targets and renewal actions identified from condition assessments for each asset category are provided in the following sub-sections.

**5.4.1 Subtransmission lines**

LIFE CYCLE ASSESSMENT

	Poles	Lines
ODV Standard Life (Wood/Concrete)	45/60	60
Population Size (Wood/Concrete)	1333/1027	335km
Steady state renewal rate p.a.	46	5km
Premature failures /Opportunistic renewal	7	0.2km
10year renewal rate p.a.	58	0
Start of failure period	44years	60years
Failure period duration	10 years	20years
Targeted renewal rate	80 to 60	0.2km
Rate of Growth Additions/Upgrades	0	0
Steady state less renewal/Upgrade gap	0	0

This asset is critical to reliability and therefore renewal programs aim to renew asset before failure in service. In addition any known defects are to be dealt with within a year. The renewal rate required over the next 10 years is higher than the steady state rate. Condition assessments have confirmed the need for renewal over steady state rates. Premature failures account for renewal of poles that fail due to external causes. E.g. Car-hit-pole, Land slips, Falling Trees, Severe storms.

Where insulator, cross-arm, conductor spans or partial pole condition issues are identified the entire (pole) asset or line section is replaced if the total required maintenance expenditure exceeds 50% of the cost of new asset. This is common in cases where future shutdown or travel costs to correct arising defects are likely. In addition where high outage cost or helicopter work is associated with a group of poles being renewed opportunistic renewal of associated poles approaching end of life is carried out to reduce overall costs. This is typical for the East-coast 50kV and Mahia 33kV spur line renewal work.

A back log of defects identified from inspections has increased to a level where it is necessary to increase the short term targeted renewal rate. If the backlog of defects increases, then the planned renewal rate will need to increase.

The target renewal rate to accommodate the 10year renewal rate, premature renewal and correction of defects is set at 80 poles p.a. until 2012/13 with a reduction to 60 poles p.a. from 2013.

Age renewal for conductor assumes 60 to 80 year life hence no planned replacement is currently undertaken or required.

Summary of Actions

- Renew 80 poles per year to 2012/13. \$400,000
- Steady state renewal 60 poles per year from 2013 \$300,000
- Fault replacement Line \$40,000

**5.4.2 11kV Lines and Cables**

LIFE CYCLE ASSESSMENT (Lines)

	Poles	Lines
ODV Standard Life (Wood/Concrete)	45/60	60
Population Size (Wood/Concrete)	14792/10214	2410km
Steady state renewal rate p.a.	500	40km
Premature failures /Opportunistic renewal	30	2.25km
10year replacement rate p.a.	660	17km
Start of failure period	44years	60years
Failure period duration	10 years	20years
Targeted renewal rate	600	9 to 18km
Rate of Growth Additions/Upgrades	30	2.25 km
Steady state less renewal /upgrade gap	60	8km

The 8km p.a. gap between the 10 year renewal rate plus premature renewal and the targeted renewal rate plus the replacement due to upgrade work, is identified as a long term issue for the conductor assets. The factors influencing the ability to address this issue include economic justification/regulatory revenue constraint, the availability of physical resources and controls on outages required to undertake the work.

In the medium term the effect of a shortfall in investment in renewal of 11kV conductor is addressed in part by ENL's strategy for uneconomic lines described in Section 4.7. In the long term renewal investment shortfall will affect ENL's ability to achieve customer expectations of steady state performance and regulatory performance targets.

The gap of 60 poles p.a. between the 10 year renewal rate plus premature renewal and targeted rate of 600 per annum plus the replacement due to upgrade work, is also an issue for 11kV pole assets. Similarly to 11kV conductor the factors influencing the ability to address this issue include economic justification, availability of physical resources and controls on outages required to undertake the work.

In the medium term the effect of constrained investment in renewal of 11kV poles is addressed in part by ENL's strategy for uneconomic lines described in Section 4.7. In the long term renewal investment shortfall may affect ENL's ability to achieve customer expectations of steady state performance and regulatory performance targets.

In view of the gap for both poles and line it is necessary to determine priorities for the renewal work. This is done in accordance with the processes and policies for management of risk in section 6.2. The combination of economic, performance and other risk assessment factors for uneconomic rural lines clearly categorises this asset as the lowest priority for renewal while Population centres, Main feeders and Tie feeders have the higher priorities.

A consequence of the gap is the predicted decrease in primary customer service levels which when offset by improvement strategies form the basis for the prediction that the primary service levels will remain close to the current levels.

The conductor renewal target of 3km p.a. until 2016 increases beyond this time to 6km. Analysis indicates that the primary customer service levels are likely to exceed regulated limits due to the necessary increase in planned shutdowns to achieve the renewal work. This increase in outages will exceed any reduction brought about by the improved reliability of the new lines.

As the majority 11kV reticulation in both Wairoa and Gisborne CBDs has been already undergrounded there is little undergrounding required to be undertaken during the planning period. The two exceptions are in 2016/17 and 2017/18 when an allowance of \$350k per year is made to underground areas on the fringe of the Gisborne CBD. Here, domestic dwellings are being replaced by commercial buildings which protrude into the alignment of existing overhead

reticulation. The undergrounding of Roebuck & Disrallei Streets and Childers & Grey Streets will also facilitate an increase in available capacity as required by the new commercial buildings.

**LIFE CYCLE ASSESSMENT (Cables)**

ODV Standard Life	45/70
Population Size	143
Steady state renewal rate p.a.	2
Premature failures /Opportunistic renewal	0.5km
10year replacement rate p.a.	0km
Start of failure period	50years
Failure period duration	20 years
Targeted renewal rate	0km
Rate of Growth Additions/Upgrades	2km
Steady state less renewal /upgrade gap	0km

Cable replacement is solely driven by the need for capacity upgrades and new work which is identified on a project-by-project basis. Therefore targeted replacement due to age is 0km. When multiple failures are experienced on sections of cable replacement is built into project work. Currently there are no projects specifically in this category.

**Summary of Actions**

- Renewal Conductor 9km p.a. to 2016/17 \$360,000
- Renewal Conductor 18km p.a. from 2016/17 \$720,000
- Premature conductor replacement \$90,000
- Pole Renewal 650 \$1700,000
- Premature pole renewal \$100,000
- Premature Cable renewal 0.5km \$100,000

**5.4.3 LV Lines and Cables**

**LIFE ASSESSMENT (Lines)**

Poles Lines

ODV Standard Life (Wood/Concrete)	45/60	60
Population Size (Wood/Concrete)	4647/1931	540km
Steady state renewal rate p.a.	137	9km
Premature failures /Opportunistic renewal	30	0.2km
10year replacement rate p.a.	70	5km
Start of failure period	44years	60years
Failure period duration	10 years	20years
Targeted renewal rate	100	0km
Targeted rate of Reduction	20	1km
Rate of Growth Additions/Upgrades	0	1km
Steady state less renewal /upgrade gap	0	3km

Pole renewal will occur as a maintenance action indefinitely until there is a need to reconductor for capacity. At this time all poles will have to meet increased strength requirements to carry the heavier conductor. Where appropriate underground conversion is undertaken at a rate of up to 1km per year. Considerations applied when selecting which streets to underground are;

- The existing overhead assets are due for replacement because of age deterioration or operational constraints.
- The delivery of maximum safety, amenity value and aesthetic improvement, i.e. undergrounding of main arterial urban streets on the fringes of CBDs and/or adjacent to schools and public parks.
- The proportion of existing private service mains that have already been converted to underground.

LIFE ASSESSMENT (Cables)

ODV Standard Life	45
Population Size	258
Steady state renewal rate p.a.	5
Premature failures /Opportunistic renewal	1.0km
10year replacement rate p.a.	1.8km
Start of failure period	45years
Failure period duration	20 years
Targeted renewal rate	1.0km
Rate of Growth Additions/Upgrades	3.0km
Steady state less renewal /upgrade gap	0km

Summary of Actions

- Pole Renewal 100 \$200,000
- Line renewal with underground 1km \$150,000



- Premature cable replacement 1km \$80,000
- Premature Line renewal \$40,000

**5.4.4 Service connections**

LIFE ASSESSMENT (Service pillars)

	(Service pillars)	OH Fuses
ODV Standard Life	45	45
Population Size	6097	29770
Steady state renewal rate p.a.	135	661
Premature failures /Opportunistic renewal	30	-
10year replacement rate p.a.	80	661
Start of failure period	45years	45
Failure period duration	10 years	10
Targeted renewal rate	140 to 120	500
Rate of Growth Additions/Upgrades	100	-
Steady state less renewal /upgrade gap	0	-

While the age profile of the service pillars indicates a required 10 year renewal rate of 80 per year plus opportunistic renewal of 30 per year, Inspections and condition assessments have indicated a higher required renewal rate of 140. This rate is scheduled until 2012 at which time a reduction to 120 p.a. is planned. This is because ENL is separating its equipment from shared boundary-meter boxes and either relocating into separate new service fuse boxes and/or contributing to the relocation of the metering equipment. Primary justification for the separation work is to improve safety with age renewal being the secondary justification.

In some cases expenditure is warranted to allow other work on network assets to proceed. This is allowed for within the funding provided for the other assets.

Summary of Actions

- Service Disconnect Boxes to replace shared meter box \$30,000
- Service pillar renewal \$40,000
- Meterboard Installation associated with GavlBox Renewal \$25,000

**5.4.5 Load Control**

Combined renewal and development strategies are contained in section 4.7.1.4 of this plan.

Summary of Actions

- Ripple relay renewal \$10,000
- Wairoa pilot system \$25,000

**5.4.6 Zone substations**

Renewal of fences, failing drainage, building renovations (e.g. roofing) and other significant land and building related items as identified from condition inspections is allowed for at \$20,000p.a. until 2012 reducing to \$10,000p.a.

**5.4.7 Zone Substation Transformers**

As Zone transformers are considered critical assets renewal has been determined by consideration of each individual Transformer. Factors considered include external and internal condition, History of operation, development plans, losses, and age.

Transformers currently identified for renewal are as follows...

Year	Action	Cost
2016/2017	Replace T1 at Tolaga with 1x 2.5MVA 3-Phase	\$500,000
2014/2016	Replace T1 and T2 Patutahi with 1x 5MVA 3-Phase	\$700,000
2017/2018	Replace T1 Puha with 1x 5MVA 3-Phase	\$500,000

**5.4.8 Circuit breakers**

LIFE ASSESSMENT

ODV Standard Life	40
Population Size	192
Steady state renewal rate p.a.	5
Premature failures /Opportunistic renewal	0
10year replacement rate p.a.	1
Start of failure period	35 years
Failure period duration	10 years
Targeted renewal rate	Discrete Program
Rate of Growth Additions/Upgrades	1
Steady state less renewal /upgrade gap	0

Replacement of CB's is justified on the basis of maintenance savings and risks of failure. The cost of major refurbishment overhauls of the CB's has been in the order of 25% of a new unit giving an expected 25% life extension. This has allowed the CB replacement program to be managed over a more controlled timeframe. More recently new CB costs have reduced hence refurbishment is now uneconomic by comparison with life expectancies.

## 50 kV Circuit Breakers

Location	Function	Make	Cost	Replace
Ruatoria	T1	Bulk Oil Metro Vic	\$80k	2013/14
Tokomaru	T1	Bulk Oil Metro Vic	\$80k	2014/15
Tolaga	T1	Bulk Oil Metro Vic	\$80k	2016/17
Carnarvon	T1	Reyrolle Min Oil	\$80k	2020/21
Makaraka	Line to Patutahi	Reyrolle Min Oil	\$80k	2018/19
	Inject Plant	Reyrolle Min Oil	-	2020+

## 11 kV Circuit Breakers

Location	Make	REPLACE
Carnarvon Sub	Reyrolle LMT	2013/14
Carnarvon Sub	Reyrolle LMT	2013/14
Carnarvon Sub	Reyrolle LMT	2013/14
Carnarvon Sub	Reyrolle LMT	2013/14
Carnarvon Sub	Reyrolle LMT	2013/14
Carnarvon Sub	Reyrolle LMT	2013/14
Carnarvon Sub	Reyrolle LMT	2013/14
Carnarvon Sub	Reyrolle LMT	2013/14
Carnarvon Sub	Reyrolle LMT	2013/14
Carnarvon Sub	Reyrolle LMT	2013/14
Carnarvon Sub	Reyrolle LMT	2013/14
Carnarvon Sub	Reyrolle LMT	2013/14
Carnarvon Sub	Reyrolle LMT	2013/14

The Carnarvon Substation Oil filled moving portion (trucks) have been identified for renewal by routine maintenance assessments. Replacement, (including protection relay upgrade) has been programmed for 2013/2014 @ \$320,000

Rural automation CBs are being renewed as maintenance\replacement triggers are reached with expenditure scheduled at \$25,000 bi-annually.

## 5.4.9 Distribution Transformers

	Small	Large
ODV Standard Life	45 years	45 years
Population Size	3058	571
Steady state renewal rate p.a.	68	16
Premature failures /Opportunistic renewal	18	4
10year replacement rate p.a.	40	10
Start of failure period	45 years	45 years
Failure period duration	10 years	10 years
Targeted renewal rate	40	Discrete Program
Rate of Growth Additions/Upgrades	30	6
Steady state less renewal /upgrade gap	0	0

The low cost of new transformers, high cost of operating maintenance facilities and longer life expectancy of new transformers makes replacement the preferred option compared to traditional maintenance.

Renewal costs are forecast for 40 p.a. at \$2600 each for small transformers and average 9 p.a. at \$255,000 each for large transformers. The expenditure incorporates an allowance for replacement fuses, minor circuit alterations and earthing work to accommodate the transformer renewal.

While small transformers are only replaced as they fail or on an opportunistic basis, large transformers a programmed based on condition and needs assessments. The program for large transformer replacements is as follows...

Year	Name	Location	Rating	Total cost
<b>2012/2013</b>				
	B927	Pine St near Stout St	300 kVA	\$30,000.00
	B42	King St near Hospital Rd	300 kVA	\$35,000.00
	W1530	Glengarry Place, Wairoa	300 kVA	\$35,000.00
	A350	224 Tyndall Rd/1 Gillies Boundary	300 kVA	\$30,000.00
	B936	Peel St and Lowe St (back alleyway behind Odeon)	250 kVA	\$25,000.00
	A481	Wainui Rd, Gordon Gecko	250 kVA	\$30,000.00
	B358	Grey St, by Gladstone Rd (T & G)	100 kVA	\$25,000.00
	B359	Grey St (Back alley Salvation army)	300 kVA	\$35,000.00
				\$245,000.00
<b>2013/2014</b>				
	A107	Tatapouri SH35 in drive 10m left	100 kVA	\$25,000.00
	B318	Awapuni Rd (Aitkens Concrete)	250 kVA	\$25,000.00
	A320	42 Ida Rd near Donna St	300 kVA	\$35,000.00

	B431	Golf course Awapuni Rd side opp Pacific St by 5th Tee	100 kVA	\$25,000.00
	B328	Awapuni Rd, by Stanley Rd	100 kVA	\$25,000.00
	B152	Disraeli St near Gladstone Rd (sunshine breweries)	250 kVA	\$25,000.00
	A32	215 Tyndall Road	250 kVA	\$30,000.00
	A416	40 Gaddums Hill	100 kVA	\$25,000.00
	A389	Kaiti Beach Rd by Port	500 kVA	\$35,000.00
				\$250,000.00
<b>2014/2015</b>	B132	452 Palmerston Rd/Roebuck Cnr	250 kVA	\$35,000.00
	F400	3183 Matawai Rd	250 kVA	\$30,000.00
	W1582	Outram St, Apatu Street Corner, Wairoa	200 kVA	\$30,000.00
	B321	Olympic Pool opp 23 Awapuni Rd	250 kVA	\$30,000.00
	B287	621 Childers Rd across from ex Sandown	250 kVA	\$35,000.00
	B551	Solander St, Montana ex Corbans	250 kVA	\$25,000.00
	H75	4 Tokomaru St, Tokomaru Bay	250 kVA	\$30,000.00
	B436	Solander/Banks St Cnr	300 kVA	\$35,000.00
				\$250,000.00
<b>2015/2016</b>	B814	MacLean St, by Ormond Rd	300 kVA	\$35,000.00
	C637	Main Road Makaraka - race course by stand	100 kVA	\$25,000.00
	D579	64 Bilham Rd, Patutahi	250 kVA	\$30,000.00
	B379	OPP 554 Childers road ex Orange Grove	500 kVA	\$40,000.00
	B932	Richardson Ave/Russell St Cnr	250 kVA	\$35,000.00
	W1569	99 Lahore St, Wairoa	200 kVA	\$30,000.00
	W1547	55 Black St, Wairoa	200 kVA	\$30,000.00
	W1562	Between Marine Parade and Queen Street	50 kVA	\$25,000.00
				\$250,000.00
<b>2016/2017</b>	B870	Opp 34 Mill Rd (Te Hapara School)	250 kVA	\$35,000.00
	W308	Western Extension, Tuia	300 kVA	\$30,000.00
	W1557	39 Queen St	500 kVA	\$40,000.00
	B375	Rectory (end of Desmond Road)	250 kVA	\$30,000.00
	W1534	31 River Parade, Wairoa	200 kVA	\$30,000.00
	W1539	Corner of Lucknow St and King St, Wairoa	200 kVA	\$30,000.00
				\$195,000.00
<b>2017/2018</b>	W1543	56 Mitchell Rd, Wairoa	100 kVA	\$30,000.00
	C310	Nelson Rd 'Richardson Mill'	250 kVA	\$25,000.00
	H322	Te Puia Springs GDC Offices	100 kVA	\$25,000.00
	B849	43 Oak Street	250 kVA	\$30,000.00
	W1542	32 Mitchell Rd, Wairoa	100 kVA	\$25,000.00
	B622	186 Stout St near Poplar St	300 kVA	\$35,000.00

	B83	12 Mary St/opp George St/near Edward St	300 kVA	\$35,000.00
				<u>\$205,000.00</u>
<b>2018/2019</b>	A341	Ropata Street/Wainui Rd cnr	300 kVA	\$35,000.00
	B34	481 Aberdeen Rd opp Victoria St	300 kVA	\$35,000.00
	A267	Kelvin St/Vivian St Cnr	200 kVA	\$30,000.00
	A351	Rutene Rd between Hinaki St and De Lautour Rd	200 kVA	\$30,000.00
	B119	12 Scott St near Kent St	300 kVA	\$30,000.00
	B482	52 Centennial Cres near Endeavour St	300 kVA	\$35,000.00
				<u>\$195,000.00</u>
<b>2019/2020</b>	B258	Bright St, Treble Court	500 kVA	\$40,000.00
	A50	56 Paraone Rd near Worsley St	300 kVA	\$30,000.00
	B430	Lowe St (Alleyway 89 FM ex masonic)	500 kVA	\$20,000.00
	B908	Carnarvon/Kahutia Sts cnr Med - Lab	200 kVA	\$30,000.00
	A102	35 Makarori Beach Road	250 kVA	\$30,000.00
	C508	315 Matawai Rd SH	50 kVA	\$20,000.00
	B175	47 Sunvale Crs near Fox St	200 kVA	\$30,000.00
				<u>\$200,000.00</u>
<b>2020/2021</b>	H289	Hiruharama Rd, Marae	100 kVA	\$25,000.00
	D440	67 Bolitho Road	50 kVA	\$20,000.00
	B685	307 Lytton Rd, Te Kuri Marae	100 kVA	\$25,000.00
	B184	Grey Street, 'findlays'	250 kVA	\$25,000.00
	B440	Fergusson Drive	300kVA	\$30,000.00
	B534	Lytton Rd Pensioner Flats	300kVA	\$30,000.00
	A430	41 Darwin Rd	200 kVA	\$30,000.00
	D392	Bushmere Rd by No 599	50 kVA	\$20,000.00
				<u>\$205,000.00</u>
<b>2021/2022</b>	J160	TUPAROA RD MANUTAHU SCHOOL	100 kVA	\$25,000.00
	F231	6517 Maiawai Rd, Township Shops	250 kVA	\$30,000.00
	D388	9 Jackson Rd	250 kVA	\$25,000.00
	D539	31 Brown Rd	100 kVA	\$25,000.00
	J454	1 College Road South Ruatoria	200 kVA	\$30,000.00
	C413	415 Bushmere Rd	250 kVA	\$30,000.00
	J486	138 Te Araroa SH just north of Ruatoria	100 kVA	\$25,000.00
				<u>\$190,000.00</u>

## Summary of Actions

- Transformer Renewal <100kVA 40p.a. \$100,000

- Transformer Renewal >100kVA 9 p.a. \$255,000

**5.4.10 Pole Mounted Isolation Equipment**

LIFE ASSESSMENT (ABS and SF6 SW's)

	ABS and SF6 SW's	Fuses
ODV Standard Life	35 years	35 years
Population Size	588	3802
Steady state renewal rate p.a.	17	109
Premature failures /Opportunistic renewal	6	8
10year replacement rate p.a.	33	206
Start of failure period	38 years	42 years
Failure period duration	10 years	7 years
Targeted renewal rate	10 to 5	50
Rate of Growth Additions/Upgrades	2	10
Steady state less renewal /upgrade gap	0	0

Expenditure for transformer fuse replacement is included in the transformer renewal allowance at a rate of 40 sets p.a.

Summary of Actions

- Renew ABSs at a rate of 10/yr \$100,000 p.a.
- Steady state fuse-set renewal of 33/yr \$40,000 p.a.

**5.4.11 11kV Switchgear (ground mounted)**

LIFE ASSESSMENT

ODV Standard Life	40
Population Size (Operational Switches)	911
Steady state renewal rate p.a.	23
Premature failures /Opportunistic renewal	9
10year replacement rate p.a.	8
Start of failure period	20 years
Failure period duration	25 years
Targeted renewal rate	Discrete Program
Rate of Growth Additions/Upgrades	13

Steady state less renewal /upgrade gap 0

The following list details the renewal program. The costs include associated cabling and alterations.

Year	name	location	Model	Total
<b>2012/2013</b>	A Park Wairoa		SD series	\$75,000.00
	Rockford House		SD series	\$50,000.00
				<u>\$125,000.00</u>
<b>2013/2014</b>	B734	Disraeli St near Gladstone Rd	SDAF3	\$20,000.00
			SDAF	\$15,000.00
			SDAF	\$15,000.00
			<u>\$50,000.00</u>	
<b>2014/2015</b>	B618	Banks St, Opp Solander St	SDAF3	\$20,000.00
	B351	Stout St, Ash St Corner	SDAF3	\$20,000.00
	B781	Ormond Rd, Opposite Dalrymple ST	SD3	\$20,000.00
			<u>\$60,000.00</u>	
<b>2015/2016</b>	B808	McLean St, Ormond Rd Corner	SDAF3	\$20,000.00
	A187	Rawiri Street	SDAF3	\$20,000.00
	B801	Massey Rd, Oswald St corner	SD3	\$20,000.00
	A288	Tyndall Road No 183	SDAF3	\$20,000.00
			<u>\$80,000.00</u>	
<b>2016/2017</b>	B778	Hospital Rd, Ormond Rd corner	SD3	\$20,000.00
	A200	Alice Street	SDAF3	\$20,000.00
	B801	Massey Rd, Oswald St corner	SD3	\$20,000.00
			<u>\$60,000.00</u>	
<b>2017/2018</b>	B979	Childers Rd, Warehouse	SDAF3	\$20,000.00
	A300	Huxley Road Outside Gis Hotel	SDAF3	\$20,000.00
			SDAF	\$15,000.00
			<u>\$55,000.00</u>	
<b>2018/2019</b>	B765	Mangapapa Rd, Ormond Rd Corner	SDAF3	\$20,000.00
			SD	\$10,000.00



	C595	Nelson Rd, near Campion Rd	SDAF3	\$20,000.00
			SDAF	\$15,000.00
				<u>\$65,000.00</u>
<b>2019/2020</b>	B768	Stout St, Opposite No 175	SDAF3	\$20,000.00
	A281	Delatour Rd opposite Shops	SDAF3	\$20,000.00
	A448	Paraone Rd, No 56	SDAF3	\$20,000.00
				<u>\$60,000.00</u>
<b>2020/2021</b>	A325	Hirini Street, Wainui Rd Cnr	SDAF3	\$20,000.00
			SD	\$10,000.00
	B612	Rua St near Ormond Rd	SDAF3	\$20,000.00
			SDAF	\$10,000.00
				<u>\$60,000.00</u>
<b>2021/2022</b>	A331	Harris St, Wainui Rd Cnr	SDAF3	\$20,000.00
			SDAF	\$15,000.00
	B486	Lowe St, 89 FM	Hazemeyer	\$10,000.00
				<u>\$45,000.00</u>

An allowance is made for unplanned renewal of \$40,000p.a.

### 5.4.12 LV Switchgear

#### LIFE ASSESSMENT

ODV Standard Life	45
Population Size (Operational Switches)	2900
Steady state renewal rate p.a.	64
Premature failures /Opportunistic renewal	4
10year replacement rate p.a.	14
Start of failure period	40 years
Failure period duration	10 years
Targeted renewal rate	18
Rate of Growth Additions/Upgrades	10
Steady state less renewal /upgrade gap	0

Transformers typically contain 4 to 6 Operational Switches per Frame while Link boxes have 2 to 3 operational switches per frame.

Funding for 18 LV switches which equates to approximately 6 link boxes per annum is provided at \$40,000.

Funding for replacement of LV Frames is provided in transformer replacement funding.

## 5.4.13 Control and protection

Protection equipment traditionally lasted the life of the device it protected. However as protection schemes are required to co-ordinate across both ENL's network and Transpower's points of connection, protection equipment must maintain technical and functional compatibility with ENL's and/or Transpower's latest protection operating standards. Generally this results in protection equipment requiring technology upgrading before age or condition replacement.

### Voltage Control

Voltage regulators are currently fitted with mercury filled switch mechanisms. Replacement with PLC controls is planned when the existing units show signs of mal-operation due to mechanical wear forecast details are as follows

Station	AVRControl Tentative Renewal Date	Cost \$
Ngatapa V_Reg	2012/2013	5,000
Pehiri V_Reg	2013/2014	5,000
Kopuroa V_Reg	2014/2015	5,000
Waihua V_Reg	2015/2016	5,000
Matawai V_Reg	2016/2017	5,000
Waingake V_Reg	2017/2018	5,000
Kanakania V_Reg	2018/2019	5,000
Tatapouri V_Reg	2019/2020	5,000

\* Replacement undertaken as items fail

### Battery Systems

Rural Automation sites operate either 12 or 24V DC battery systems

Substation systems include the 110V banks and 24V systems incorporating redundancy with Dual 24V chargers and Batteries. The steady state cost to maintain Batteries and Charges at these sites is \$20000 p.a.

Station	24V Charger Renewal	110V Charger Renewal

	Required	
TeAraroa	2012/13	NA
Tolaga	2013/14	NA
Tokomaru	2012/13	NA
Kiwi	2013/14	NA
Ruatoria	2013/14	NA

## Protection

Steady state allowance of replacement of components following

Station	Feeder Protection RenewalYear	Transformer Protection Renewal Year	50KV Protection Renewal Year
Kiwi	2021/22 \$80k	2021/22 \$14k	2021/22 \$6k
Carnarvon St	2013/14 \$90k	2024	2024
Parkinson St	2010/12 \$80k	2024	2024
Kaiti	2010/12 \$80k	2024	2024

Premature failure is allowed for at \$10,000p.a.

### 5.4.14 Communications

Generally technology upgrade occurs before age or condition replacement; however ENL's strategy has been to defer the renewal until such time as the operational performance and condition of the equipment necessitates the change.

As the Radio communications network is predominantly radial in nature benefits of the new technology incorporated into the new equipment can be released sooner if the network is replaced starting at the communications hub spreading outwards to the remote regions. Equipment removed, in some cases, that has some remaining service life is relocated to the remote areas for the short term if necessary until renewal is appropriate.

Forecast expenditure is provided at \$60k p.a until 2013/14 to progressively renew the radio communications assets.

Renewal of the Voice RT network to facilitate the required change to narrow band is planned between 2015-2017 at \$230k.

Cable circuits will not be renewed.

Fibre Optic circuits installed between 2002/2006 are expected to survive the planning period of this plan before renewal is required.

An allowance of \$20,000 p.a. is provided for unplanned renewal as a result of premature failures.

#### **5.4.15 SCADA**

The original GPT master station and data-term RTU's were replaced between 2000 and 2002 with the current Abbey system. As the system is progressively upgraded to maintain currency no planned major upgrade or replacement for the Abbey system is programmed. Unplanned renewal of failed equipment should assume \$10,000 p.a. between major upgrades.

#### **5.4.16 Generators**

Renewal timing and costs for standby generation assets associated with communication and SCADA assets are as follows...

Generator Location	Renewal Date	Cost
Carnarvon St	2020/22	\$20,000
Makaretu	2020/22	\$10,000
Arakihi	2020/22	\$10,000
Mata Rd	2020/22	\$10,000
Whakapunaki	2020/22	\$10,000
Tikitiki	2020/22	\$10,000

### **5.5 Up-sizing or extending the assets**

If any of the capacity triggers in Table 4.1.3(a) are exceeded ENL will consider either up-sizing or extending the network. These two modes of investment are, however, quite different as described in Table 5.5(a) below.

**Table 5.5(a) – Distinguishing between up-sizing & extension**

Characteristic	Up-sizing	Extension
Location	Within or close to existing network footprint (within a span or so).	Outside of existing network footprint (more than a few spans).
Load	Can involve supply to a new connection within the network footprint or increasing the capacity to an existing connection.	Almost always involves supply to a new connection.
Upstream reinforcement	Generally forms the focus of up-sizing.	May not be required unless upstream capacity is constrained.
Visible presence	Generally invisible.	Obviously visible.
Quadrant in Figure 4.1.2(b)	Either 1 or 2 depending on rate of growth.	Either 3 or 4 depending on rate of growth.
Necessity	Possible to avoid if sufficient surplus capacity exists. Possible to avoid or defer using tactical approaches described in section 4.2.1.	Generally can't be avoided – a physical connection is required.
Impact on revenue	Difficult to attribute revenue from increased connection number or capacity to up-sized components.	Generally results in direct contribution to revenue from the new connection at the end of the extension.
Impact on costs	Cost and timing can vary, and be staged.	Likely to be significant and over a short time.
Impact on ODV	Could be anywhere from minimal to high.	Could be significant depending on length of extension and any consequent up-sizing required.
Impact on profit	Could be anywhere from minimal to high.	Could be minimal depending on level of customer contribution.
Means of cost recovery	Most likely to be spread across all customers as part of on-going line charges.	Could be recovered from customers connected to that extension by way of capital

		contribution.
Nature of work carried out	Replacement of components with greater capacity items.	Construction of new assets.

Despite the different nature of up-sizing and extension work, similar design and build principles are used as described in section 5.5.1.

The forecasts for new assets and asset extensions other than those identified in the development program are difficult to predict as they are generally short term customer driven activities. Section 5.5.2 identifies the predictions for these activities.

## **5.5.1 Designing new assets**

ENL uses a range of technical and engineering standards to achieve an optimal mix of the following outcomes...

- Meet likely demand growth for a reasonable time horizon including such issues as modularity and scalability.
- Minimise over-investment.
- Minimise risk of long-term stranding.
- Minimise corporate risk exposure commensurate with other goals.
- Maximise operational flexibility.
- Maximise the fit with soft organisational capabilities such as engineering and operational expertise and vendor support.
- Comply with sensible environmental and public safety requirements.

Given the fairly simple nature of the network ENL tends to adopt standardised designs for all asset classes with minor site-specific alterations. These designs, however, will embody the wisdom and experience of current standards, industry guidelines and manufacturers recommendations.

### **5.5.1.1 Subtransmission Lines**

Construction of new or replacement asset will adhere to following standards...

- Concrete poles (unless limited by weight for helicopter installations)
- Cross-armless delta configuration, and cross-armless angles for live line compatibility
- If phase separation dictates use of crossarms, then steel arms with flat post insulator construction are used
- Polymer strain insulators – no strings
- No LT under building
- Avoid main highway line routes
- Standard conductors: Cockroach – urban, Dog – rural
- All poles to be fitted with possum guard
- Line make-offs/staying approximately every 12<sup>th</sup> pole if there are no intermediate make-offs or angles
- Conductor spacing and insulation to minimum 66kV standard

### **5.5.1.2 Distribution Lines and Cables**

Construction of new or replacement asset will adhere to following standards...

Lines

- Concrete poles (hard wood poles where load/strength characteristics cannot be matched)
- Crossarms mounted 200mm below top of pole
- Longer crossarms (2.4m ) for live line friendly spacing
- Polymer strain insulators – no strings or kidney
- Line routes to adhere to road reserve where possible though a continuing issue exists with Transit NZ whose minimum draft standards for pole clearance in relation to the edge of road seal, (i.e. 9m clearance in 100km/hr areas) is proving challenging.
- Standard conductors - Dog – Urban and Rural ties
- Insulators to minimum 15kV standard and for coastal areas 25kV
- Insulators fitted 100mm in from crossarm ends
- All poles to be fitted with possum guard, and pole cap if wooden
- Hardwood strain pole required every 2km in straight prop pole sections of line (to break cascade failures)
- Angle poles to be armless for live line capability.
- Mid span jumpers not permitted
- No stub poles to be used for stay anchors

Cables

- No pitch terminations to be reinstated if any work undertaken
- Terminations on poles to be protected with surge diverters
- Standard cable sizes: 300mm 185mm 95mm AL ,16mm CU
- No cable to cable T connections

### **5.5.1.3 LV Lines and Cables**

Construction of new or replacement asset will adhere to the following standards...

- No reinstatement of pilot
- No reinstatement of O/H street lighting
- Wasp PVC covered conductor for overhead
- Beetle (106mm<sup>2</sup>) domestic cabled LV reticulation
- Huhu (185mm<sup>2</sup>) commercial cabled LV reticulation
- 25mm<sup>2</sup> NS Cu. For road crossings
- No under-building on 50kV poles
- Cables to be run for first span from distribution sub.
- No more than 1 termination per pole.
- Designs to consider elimination of road crossings, overhead crossovers, mid span jumpers and substation by-pass via overhead circuit.

LV conductors are fused to full duty capacity, i.e. no short duration duty cycle peaks are permitted. This prevents accidental overload as no monitoring is undertaken and there is little control over the load connected in customers' installation. No de-rating is made for damage, aging or trenching conditions. This sets the upper limits on conductor capacity at rating.

The low level of protection and management of load is traded off against longevity of service.

Overhead conductor is installed with an excess contingency capacity of 20% while cables have a contingency capacity of 33%. This contingency erodes with load growth until load equals rated capacity.

### **5.5.1.4 Service Connections**

Domestic installations have traditionally been supplied via 4 wire (2 phases, pilot, and neutral) service lines. This was a means of keeping



conductor size small by meeting capacity requirement via more conductors.

Single phase connections, without pilot, are the preferred standard. This reduces the quantity of connection hardware by 66% and reduces the probability of equipment failure. This will be encouraged at the time of upgrades via a differential in fixed charges for multi phase versus single phase connections.

- All new connections and upgrades will encourage under grounding by providing the point of connection in a boundary located service fuse box, i.e. installation of pole fuses will be discontinued. This cleans down the structures of hardware, aids accessibility, and prepares the way for under grounding the main line.
- Pole fuses will still be permitted in rural areas however preferred connection will be via cable only to eliminate pole loading issues.
- For customers not wishing to underground a UDOS pole located on their property is an alternative.
- During renewal programs no pilot wire will be reinstated. The installation will be converted to ripple control.

#### **5.5.1.5 Zone Substations**

Earthing at Zone substations is carried out in accordance with the codes of practice. In general 70mm<sup>2</sup> CU conductor is used with cad-weld connections and copper-clad rods driven at each conductor intersection. The design of the grid is specific to each site and varies depending on soil re-sensitivity factors.

The requirement for containment is determined by the quantity of oil that could spill in the event of a single rupture. For equipment with low oil quantities less than 200 liters oil spill kits and spill procedures provide for containment and clean-up to minimise environmental damage. Equipment that falls into the low oil quantity category includes switchgear and distribution transformers. For high oil quantities the work comprises, installation of concrete oil containment areas and the installation of oil separators to separate oil from the storm water under normal operating conditions. The requirement for oil containment at a site is dependent on the quantity of oil that could be spilt in any single event.

New building standards include raised buildings (approx 1 metre) to reduce risk from flooding and allow cable access from underneath.

Where wooden duct covers have been used and have begun to deteriorate they are being replaced with metal covers to reduce fire risks and the chance of failure under load. Alterations carried out on the buildings, as maintenance is required include the removal of windows in buildings where indoor 11kV switchgear is used and replacement of wooden doors and window frames with low maintenance aluminum fittings.

The layout of substation yards has been designed to allow crane access for installation and removal of the large transformer without interference from the overhead 11kV and 50kV lines

Oil spill kits and handling procedures are located at all zone substations to cope with oil spills from circuit breakers with lower oil quantities.

#### **5.5.1.6 Zone Substation Transformers**

- New transformers require secondary oil containment and oil separation equipment per District Plan.
- Earthquake mountings are required to have engineering certification. Connections to bushings are also designed for earthquake tolerance.
- Noise standards as controlled to requirements of the District Plan

Standard incremental Zone substation sizes used on the network are 2.5, 5/7, 12.5MVA.

Standardisation on the purchase of low cost IMP transformers from India with on site supervision of the construction has proved successful to date. Continued purchases are planned in future.

Alterations carried out on the initial IMP design that are now incorporated into new purchases include...

- Anti vibration pads between transformer and concrete pad
- Separate tap changer and transformer oil compartments in conservator tanks.
- Pressure relief valves in addition to the Buchholtz fitted to both the transformer and tap changer.
- Less than 1.5% transformer losses
- A spare tap changer is held for contingency purposes.

As opportunity permits new transformer purchases in rural locations will comprise smaller capacity 3-phase units, which allow compact substation design and reduced maintenance over the life of the units.

#### **5.5.1.7 Circuit Breakers**

Insulation levels are maintained within the manufacturer's specifications and are measured with discharge monitoring equipment or during servicing.

Indoor 11kV circuit breakers used for all Substations where multiple feeders are necessary.

Bypass and isolation arrangements are installed for 50kV CB's where no alternative supply is available.

Incomer and bus section configurations are used where dual transformer configurations exist.

All circuit breaker/feeder ratings are twice the normal feeder load to allow support of adjacent feeder loads.

##### 50 kV Circuit Breakers

Bulk oil circuit breakers are located within banded containment areas.

Outdoor CB's are used for all 50kV applications.

New 50kV CB purchases have been standardised for compatibility and reduced long term costs. Standard features include:

- SF6 outdoor
- 66kV rated minimum
- DC 24 volt operation (reduces 110V DC battery costs currently incurred due to older CB designs)

##### 11kV Circuit Breakers

- Min 400A rating and 12kA short time fault rating
- SF6 or Vacuum
- Indoor configurations for multiple feeder substations.
- Bursting discs fitted to outdoor reclosers (requirement from previous failure issues)
- Electronic protection with fully configurable curve types and settings including DNP3 or Modbus communications capabilities.
- 24v DC operating mechanisms
- Live line installation standard with bypass features using hot stick techniques

- SCADA control fitted to all remote recloser installations.
- Inclusion of Fault locators into recloser and protection schemes is also planned to optimise the overall network performance

The co-ordination density criteria for CB's, reclosers, sectionalisers, and fuses are as follows...

- Feeder CB per each substation feeder
- Field CB not more than 2 cascaded from Feeder CB
- Sectionaliser not more than 1 cascaded from Field CB
- Fuses Branch fusing on private spur lines

### **5.5.1.8 Distribution Transformers**

All transformer installations are designed to allow restoration within 8 hours.

In most cases portable generation is temporarily used to supply load during replacement of larger transformers.

The security standards adopted by ENL do not allow for temporary supply of loads as a result of smaller transformer failure.

Earth resistances step and touch and equal potential bonding standards are in accordance with the electricity act and regulations.

To upgrade earths a maximum of 6 rods (2 banks) are driven before an earth is abandoned as impractical to lower resistance. These situations are reviewed on a case by case basis as the occurrence is rare.

Strength requirements for pole mounted substations are in accordance with the outcomes of the Visim design tool.

Replacement of transformers with ground mount mini sub style units is the standard practice for transformers over 100kVA Smaller ground mount transformers are also used for replacements in rural locations where the supply is via underground 11kV cables.

- Standard transformer sizes used are 15 kVA for 1 phase supplies 30, 50, 100, 200, 300, 500, 750, 1000 kVA for 3 phase.
- All transformers above 100kVA to be ground mounted.
- All new urban substations to be ground mounted regardless of size.
- LV isolation to be provided.
- All Urban LV connections to be cable.
- Transformers greater than 500kVA shall have 3-Phase switching provided for connection and disconnection, on the HV

### **5.5.1.9 Pole mounted Isolation equipment**

Standards for Air Break Switches include...

- installations that accommodate live line replacement and maintenance techniques
- 900mm Phase separation on 11kV
- 1400mm phase separation on 50kV
- arc suppression fitted if connected capacity >1MVA on 11kV
- 50kV not used to break load unless fitted with suppression
- load break fault make rating on all new purchases

No transformers greater than 500kVA are installed using fusing protection in overhead areas.

Where sectionalisers or similar equipment are not present on rural lines air break switches are considered necessary at distances not exceeding 10km with typical connection densities of 20 to 30 per section.

Standards for Ground-mount switch installations include...

- No more than 3 transformers supplied from 1 switchboard without bus section
- Not more than 500kVA fed from switchgear supplied from a single cable circuit (excluding industrial situations)
- No more than 2 transformers and associated switchgear cascaded with no back feed
- Not more than 1 cable circuit connected directly to the bus of a switchboard arrangement.
- SF6 or Vacuum type equipment used for replacement to reduce maintenance.

11kV switchgear standards

- Extendable
- Extra height for termination ground clearance
- Independently mounted from transformer.
- 3 phase operation
- Fault make /load break
- 200A fuse tee off rating min.
- 400A Bus bar rating min.
- 12kA short time fault rating min.

### **5.5.1.10 LV Switchgear**

New LV panel installations are constructed using DIN style equipment which is mounted independently from the transformer. Incomer links are fitted to provide the ability to isolate between the transformer and the LV bus bars. This facilitates easy removal and replacement of failed transformers or connection of mobile generators.

LV tie switches are not normally installed on overhead networks interconnections are made using portable jumper sticks in fault conditions. In underground domestic reticulation boltable tie connections are made available at the open points of the LV runs.

### **5.5.1.11 Control and Protection**

New purchases of protection relays include standardisation in terms of flexibility in protection scheme design, communication using standard serial I/O protocols and interchangeable hardware.

It is desirable to keep protection equipment and design consistent across the entire network. Therefore replacement programs need to be concentrated into a 5-year timeframe.

For Transformers up to 5MVA Overcurrent /Earth Fault protection is sufficient.

Transformers over 5MVA are to have Restricted Earth fault and Differential Protection.

110V battery banks installed as single unit.

Dual 24V Battery systems are to be used where installed CB's operate on 24V and no 110V systems are installed. 24/12-volt DC-DC converters used for Radio equipment power supply.

Battery chargers and batteries including rationalisation of various supply voltages to a common voltage (i.e. 12 volt, 48 volt supplies standardised at 24volts)

Tap changer controls shall be capable of Master/ Follower or circulating current operation to cope with unbalanced conditions.

Remote manual controls are installed on tap changer controls at Zone Substations and on Voltage Regulators to allow operator intervention when automatic control relays malfunction or when voltage adjustments are necessary when paralleling between to zone substations.

### **5.5.1.12 Communications**

Construction of new or replacement asset will adhere to following standards...

- Telecom circuits 5kV isolation on all sites.
- Eastland Network pilot communications circuits 5kV isolation at all sites.
- LTCSS tone calling on all RT's
- Equipment at each end of a link to be same make, model and age.
- Power levels standardised on all repeaters at 25W. (Digital links 10W)
- Detachable head RT's to be used in vehicles.

### **5.5.1.13 SCADA**

Correct operation of the SCADA system has a direct impact on the service levels and supply restoration response times. As such the reliability requirements of the system are high.

Dual master stations, remote master connection, sub master and island operating capabilities are directly targeted at robustness of the system to faults.

The poll duration of a single SCADA port increases with the number of RTU's connected to the port. When operating remote equipment from the control room maximum poll durations of 35 seconds are targeted to ensure effective operation and feedback from the equipment being controlled. A maximum of 25 RTU's per port is necessary to achieve the targeted poll duration.

Systems connected with the SCADA system must be selected to consider use of consistent Protocols

- DNP3
- MODBUS
- ABBEY

### **5.5.2 Building new assets**

ENL uses external contractors to up-size or extend assets. As part of the building and commissioning process ENL's information records will be "as-built" and all testing documented.

The forecasts for new assets and asset extensions other than those identified in the development program are identified for each asset category as follows...

### 5.5.2.1 Distribution

The majority of distribution funding is specifically identified in the development program. Customer driven funding for distribution lines and cables is identified in the section 4.7.1.4. In most cases this funding only contributes to a portion of the total project funded by the private developer or customer. The contribution provides for the cost of increases in line or cable size beyond the minimum required for the customer which will provide for growth over the applicable planning period

### 5.5.2.2 LV Lines and Cables

Detailed analysis is only undertaken on the urban overhead network to identify exact capacity constraints when alterations are being made or to correct issues as they are identified. The cable network, which supplies commercial areas, is monitored more closely.

The trigger for upgrade is therefore a fuse blowing. Voltage complaints and transformer MDI readings can give an early warning. With load growth ranging between 0.5 and 11% it can be expected that in many cases conductor and cable will require capacity upgrade long before age replacement.

At present ENL is addressing capacity via additional transformer installation.

In the interim growth on these cables erodes contingency capacity which is being offset by availability of portable generation.

An annual provision to accommodate ENL's contribution for growth is made to install 1km of LV (urban/commercial) cable at \$80,000.

### 5.5.2.3 Service Connections/Load Control

New service connections are typically associated with subdivision work or infill housing developments. Funding is generally not provided by ENL for the work directly associated with these new connections. Provision to accommodate any contribution by ENL's for new service connections is included within the provision for LV Lines and Cables above.

An allowance of \$20,000 per annum is made for provision of ripple relays for new service connections.



#### 5.5.2.4 Transformers

Allowances for ENL's contribution for additional transformers and capacity upgrades per year to cater for typical growth are as follows. Negative growth or shifting of load centers creates redundancy of transformer installations.

Funding allowances for the anticipated growth are as follows...

Large Transformers greater than or equal 100kVA, 3 at \$140,000p.a.

Small Transformers less than 100kVA, 20 at \$78,000p.a.

#### 5.5.2.5 Switchgear ground mounted

Growth associated with this switchgear is triggered by industrial load or underground subdivision development. There are no constraints associated with the switchgear as the equipment is rated appropriately to the feeder capacities.

In general ENL is not involved with the funding for this development, allowance for 3 units or 9 switches per year is sufficient.

Allowance for ENL's contribution for subdivision and industrial growth of \$40,000 for 2 units or 6 switches per year is provided.

#### 5.5.2.6 LV Frames

Capacity upgrades assume reuse of existing LV frames.

Frame Installation as required with transformers.

Growth contingency associated with customer connections allows for 6 new Boxes per year at \$40,000.

Installation of new Distribution boxes as ENL removes its connection fuses from shared Meter boxes on customer boundaries is covered in the renewal section of this plan

#### 5.5.2.7 Communications

Allowance for 4 additional automated sites per year from 2010/11 onward is considered sufficient for long term development. These communications costs are included in the Scada section.

### 5.5.2.8 Scada

As the number of sites increases on the network the capacity of the Abbey Master station will be increased. Functionality improvements of the system are also being developed on an ongoing basis to keep the system current. Ongoing development over 10 year cycle between system replacements should assume an average annual cost of \$10,000.

Development of additional sites following completion of the rural automation program is forecast from 2010/11 costs are inclusive of Scada, communications and Actuator equipment \$25,000p.a.

## 5.6 Retiring of assets

Retiring assets generally involves doing most or all of the following activities...

- De-energising the asset.
- Physically disconnecting it from other live assets.
- Curtailing the assets revenue stream.
- Removing it from the ODV.
- Either physical removal of the asset from location or abandoning in-situ (typically for underground cables).
- Disposal of the asset in an acceptable manner particularly if it contains SF<sub>6</sub>, oil, lead or asbestos.

Key criteria for retiring an asset include...

- Its physical presence is no longer required (usually because a customer has reduced or ceased demand).
- It creates an unacceptable risk exposure, either because its inherent risks have increased over time or because emerging trends of safe exposure levels are declining. Assets retired for safety reasons will not be re-deployed or sold for re-use.

- Where better options exist to create similar outcomes (eg. replacing lubricated bearings with high-impact nylon bushes) and there are no suitable opportunities for re-deployment.
- Where an asset has been up-sized and no suitable opportunities exist for re-deployment.

## **6. Managing the risks to the business**

ENL's business is exposed to a wide range of risks. This section examines these risk exposures, describes what ENL has done and will do about these exposures, and what ENL will do when disaster strikes.

### **6.1 Understanding the business risk profile**

Arrangements for Eastland Infrastructure to provide all management and support services for all of its companies, which are all owned by the Eastland Community Trust was implemented in 2003. A new management structure was developed with new appointments being made to a number of management positions at this time.

The change in company size and structure altered the business risk profile of Eastland Infrastructure and the companies it manages. A comprehensive risk management review to facilitate the ability to manage risk in accordance with the Risk management Standard AS/NZ 4360:1999 was undertaken in August 2004. The business operations of the three businesses were reviewed against a generic set of risk areas, (Governance, Personal, Financial, Business Development, Environmental, Political, Legal, Operational, Information, Technological and Business Resilience).

Having identified risks and associated existing mitigation practices, analysis was undertaken to determine likelihood (frequency or probability) of the risk occurring and the consequence (impact or magnitude of the effect) should the risk occur. By aggregating the likelihood and consequence, risk significance was assessed both with existing treatments applied and with any additional mitigations/treatments applied. This provided a measure/review of the effectiveness of current and future risk management for each business.

The review identified the following primary exposures ...

- A number of key staff with specialised business knowledge or skills which is not sufficiently backed up. Mitigation in the form of increased staffing levels has occurred which will be effective over time, however this exposure has yet to be reduced to acceptable levels.
- An aged workforce. This exposure was evident for both personnel directly employed by the company and those engaged in contract

work for the company. A bursary program to support training in the necessary skill areas has been introduced. In addition financial support of apprenticeship initiatives within the local contractors has been promoted. It is hoped that within this framework, the ability to retain graduates and trades from the local community following training will be bring about a successful succession plan over the next 5 years. Currently the necessary personnel/skill levels within contracting companies at the local level have reached a critical low level to the extent that training apprentices in sufficient quantities is not possible.

- A high degree of uncertainty in future/proposed legislative requirements and short response timeframes affecting the ability to prepare policies systems and processes to meet the requirements. Legislative changes include those relating to the Electricity industry safety standards/working practices, use of road corridors, Resource management and consents and Regulatory control and disclosure. Dedicated staff and additional consultants have been engaged to monitor and advise and assist with the development of processes to maintain alignment with the changes. A steady increase in resource levels and their associated costs is anticipated to maintain this exposure within acceptable levels.

## **6.2 Identifying specific risks**

The risk management process as it applies to ENL's electricity network business is intended to assess exposure and prioritise mitigating actions. The process is as follows...

- Risk issues are identified and recorded.
- Minor risk issues are eliminated or controlled.
- Potential solutions/actions are developed.
- Actions are assessed against outcomes or success factors.
- Actions are ranked on the basis of weighted performance against outcomes.
- Results are then applied to cost benefit analysis in project viability tests.

### **6.2.1 Guiding principles**

ENL's behavior and decision making is guided by the following principles...

- Eastland Group endeavors at all times to purchase and provide secure risk managed products and services at the least cost and at the same time if possible secure long term contracts for purchases, services and sales.
- Only authorised contractors and personnel may transact business in Eastland Group's name and specified limits shall be maintained for such authorisations.
- ENL will only purchase or sell product or services in line with its business expertise.
- ENL will only undertake transactions with approved contractors and suppliers. Such transactions shall be maintained within specified limits.
- ENL's risk management policy and related procedures and systems are to be reviewed 2 yearly by an independent party.
- Annual internal reviews of risk management documentation are undertaken to ensure risks have been assessed correctly and that actions to reduce risks are actually taken.

### **6.2.2 Risk Categories**

ENL uses the following tactics to manage and respond to risk issues under the following broad categories...

#### **Commercial risks**

- Competition - assessments of ENL's exposure to bypass or generation are undertaken annually as part of ENL's strategic planning process. As issues arise they are discussed at monthly board meetings.
- Customer activity – regular communication is maintained with all ENL's significant consumers. In addition to growth projects ENL has policies in place to provide assistance to local businesses.
- Project management & professional liability - regular training and refreshers are carried out. Insurance policies and registrations with professional bodies

are kept up to date. Contracts with service providers define provisions required to control associated risks. Maintenance and inspection activities documented in this plan, in addition to condition assessment information target identification of hazards and non-compliance issues. Targets for elimination of the risks associated with the hazards and compliance issues are also documented for each asset category in section 8 of this plan.

- Financial - contracts with ENL consumers define liability and performance penalties. Contracts with ENL suppliers include requirements for insurance and protection of works.
  
- Emergency Preparedness - Procedures and contact lists for explosion, fire, disease, accident, injury or death incidents, and environmental accidents that may be associated with operation of ENL's main office facilities, network assets and incidents involving contractors working for the company.
  
- Disaster Recovery - Policies, plans and readily accessible documentation are maintained to maximise the effectiveness of ENL's efforts to overcome disaster events. Financial arrangements and insurance policies are in place to control the associated financial impacts resulting from events of this nature. The network is not covered by catastrophe insurance. A borrowing provision is allocated in the annual funding plan for storm and large unplanned events. Events considered in the assessments include flooding, earthquake, tsunami, war, landslips, drought, volcanic eruption, severe storms and bush fire.

### **Legal, statutory & regulatory risks**

- Financial security - quality system procedures for financial authorities and identification of ENL's representatives are in place and are externally reviewed.
  
- Confidentially- policies and quality system procedures are in place to control access to and dissemination of confidential data.
  
- Legal compliance & statutory liability - quality system procedures and 6 monthly check lists are used to ensure all obligations are met on time and to ensure issues are identified and resolved. Issues are reviewed at 6 monthly board meetings and external parties are used for procedural reviews.
  
- Health & safety - quality system policies, procedures and 6 monthly refresher training are in place. These procedures include hazard identification & control, contractor authorisation, incident reporting and standards for conduct. Self-

auditing and independent auditing requirements are included in contractual arrangements and network authorisations.

- **Public Health & safety**  
Quality system policies, procedures, and design standards serve as the control measures to minimise residual risk to levels that are as low as reasonably practicable. Both internal and external audits of the systems to ensure compliance with requirements of the regulations are carried out.

## **Information security and control risks**

- **Documentation** – quality system procedures are in place for storage and duplication of critical documentation. All critical documentation is backed up via the computer systems used to generate the documents. Risk of total loss is controlled by use of multiple storage locations throughout the region.
- **Information systems** – IT procedures are in place to provide 100% redundancy and backup for all systems used. Spares are maintained for critical equipment items. Testing of procedures and auditing of their effectiveness is undertaken on a regular basis.
- **Communications** – alternative communications systems are maintained. Use of external service providers is duplicated by ENL's own communications network. ENL maintains the ability to relay business communications via third parties based outside of the Gisborne and Wairoa regions
- **Event Management Control** - In the event the region is disjoint with respect to access or communications remote centers have been designated to enable decentralized planning and operational facilities to ensure for operations to continue at a localized level. Independent control will be delegated to a person based at each centre to run each area and liaise back to the control centre if communications are available. In the event that no communications are available, then the local centers have the ability to operate independently.

## **Physical security of resources**

- **Physical security** – Physical security provisions are maintained at all strategic sites through long-term contracts with security providers. Security systems are tested annually.
- **Land use** – legal agreements and easements are maintained for all sites considered strategic or where land use or access is vulnerable to dispute.

## **Electricity supply risks**



- Loss of bulk supply - Transpower does not include (n-1) security within contractual arrangements at Massey Rd and Wairoa GXP's. Hence there is no ability to negotiate cost penalties for loss of supply as was experienced in 2001 and 2003. The purchase of six 1MW diesel generators in 2003, when combined with the Waihi hydro scheme gives us some measure of security for up to 20% of ENL's maximum demand.
- Grid Emergency- Procedures are in place so that ENL is able to meet its obligations under the Electricity Governance Rules. These procedures include an approved participant outage plan.
- Civil Defence Emergency - ENL is actively involved in and supports preparedness through the involvement with the Hawkes Bay Regional Council and the Gisborne District Council LifeLines groups. If no priorities are identified via the liaison process with Civil Defence, then the sequence of repairs are based on the following priorities...
  - City areas where large customer numbers are disrupted.
  - Critical infrastructure, such as water supplies, sewage systems and hospital / medical facilities.
  - Commercial business appropriate to servicing emergency needs
  - Rural Townships
  - Rural areas:
    - A. Between townships
    - B. Spurs – outlying areas
- Liability for loss of supply or fluctuations - contractual arrangements and insurance policies are in place to limit ENL's exposure to the associated outcomes.
- Revenue Protection- Procedures are in place to work with Energy retailers where necessary to continually monitor identify and eliminate issues.

## **Electricity outage risks**

- Breakdown and Equipment failure - Network design and material standards are used to control the quality and suitability of product used. Care is taken to align product choice with common industry options to maximise the ability to source shortfalls. Suitability of new products and product use is the responsibility of the Asset Manager and is under continual review. Asset based solutions and standards detailed specifically for each asset. Strategic spares consist of equipment generally purchased for a project ahead of time. This equipment consists of critical items with long delivery times including 50kV/11kV transformers, 50kV switchgear & line hardware, protection, SCADA and communications equipment. Equipment that can be relocated to cover

failure of strategic items has also been identified which generally includes 50/11kV transformers, and down-stream 11kV switchgear and protection equipment that can be used to replace failure of primary feeder circuit breakers and protection. In many cases the strategy for failed equipment is to bypass the equipment and operate on reduced functionality or rely on backup systems. Minor breakdown of critical equipment is not uncommon and the processes, which have proven adequate to date, to maintain service levels are similar to those that would apply for catastrophic failure of the critical equipment. The Procedures for documentation of asset & equipment failure are in place to identify problem items or equipment.

- Resourcing - Contracts provide for minimum re-sourcing, backup re-sourcing, and response practices. Product suppliers are monitored and audited to ensure specified minimum levels of product spares and replacements are maintained in the region. Procedures and documentation are maintained to ensure product can be sourced from outside the region in a timely manner to cater for catastrophic events. Re-locatable diesel generation is available as a substitute for normal distribution supply. ENL has maintained relationships with companies not normally involved the network and through these relationships assistance and support in past large scale events has been willingly provided.
- Access to specialised equipment - Procedures and arrangements to ensure 24 hour access to specialised equipment are maintained and verified on an annual basis.
- Competency and capabilities – Skills in helicopter transportation and line reconstruction techniques are maintained to ensure risks associated with road access are controlled via alternative means. This is particularly important in remote areas of the region. To manage additional resource from outside the region, ENL staff qualifications are maintained and skilled local personnel have been identified to supervise activities maintaining work procedures, safety requirements and construction standards.
- Processes- Response Plans include pre-prepared switching and contingency plans for all sub-transmission and critical equipment. Testing of processes is undertaken as part of normal operations. In general severe storms occur 1 or 2 times per year causing damage levels beyond the normal resourcing capability. On these occasions the response processes to coordinate priorities and establish additional resource, are put in place to effect repairs. To date the systems have proven adequate. Procedures are in place for review of outages to identify any issues. Corrective actions are incorporated into contractual arrangements design standards and asset management plans as appropriate to control the risks.

### **6.2.3 Asset Management Risk Assessment**

ENL considers that a risk component applies to all projects and work undertaken. All network development projects are implemented to mitigate risks to varying degrees.

The results for identified risk issues directly relating to asset management risk assessments and action plan priorities are presented in the following matrix covering specific risk issues,

For each asset management risk currently identified:

The success factors applied are as follows...

- The weightings applied
- The assessment scores
- The resulting priorities

In general there is a strong correlation between risk priorities and current work program's. However it should be noted that risk is not the sole driver of work priorities. Risk priorities influence development plans but timings are also based on the need to co-ordinate projects.

The identified risks are addressed within the current work programs given in the Asset Management Plan. However annual review is necessary due to the rate of change in the network. This process captures new risks and adjusts priorities.

## Action Plan Priorities Ranked by Risk Reduction Outcomes

### Success Factor or Outcomes :

Reduced combined effect with other risks or increased combined provision

Improved Safety

Reduced SAIDI (improved service)

Reduced SAIFI (improved reliability)

Cost reduced

Return on investment required achieved or increased

Economic Impact to Community Reduced

Compliance and Environmental Responsibility

Public Acceptance

Meets Urgent Need

Ranking Criteria (against each Success Factor) : 1 to 10

**0: No Impact 2: Low Impact 5: Medium Impact 7: High Impact  
10: Crucial**

Priority	Section	AMP	Criteria Weightings										Score
			20	10	5	10	10	5	10	15	5	10	
1	5.4	Red tagged pole replacement high density	10	10	10	6	7	8	9	8	10	8	860
2	5.4	Red tagged pole replacement rural	8	9	10	4	7	8	9	7	9	8	770
3	5.4	Red tagged pole replacement remote	6	8	10	2	5	9	9	6	8	8	665
4	5.4.10	ABS replacement	7	2	10	3	1	8	9	10	10	8	660
5	4.7.1.2	33kV line extension Blacks Pad to Mahia	6	10	4	4	4	2	8	8	0	5	580
6	4.7.1.2	Waihi/Affco/Wairoa 33kV supply Rationalisation	4	10	6	7	4	4	3	8	0	4	530
8	5.3	Maintaining assets	10	7	10	0	4	4	0	0	10	3	460
9	4.7.1.4	CBD Security reinforcement due to growth	6	10	0	6	2	2	2	6	0	1	430
10	4.7.1.2	Matawai Supply security from Ngatapa	4	6	0	2	4	3	7	7	0	3	420
11	5.4.4	Meter/pillar replacement	10	7	9	0	0	0	0	0	8	3	385
12	5.4.11	Switchgear Replacement	6	5	4	0	0	0	4	4	6	3	350
13	5.5.2	Building new assets/upgrades	5	5	8	2	6	4	0	0	0	4	330
14	5.5.1.7	Circuit Breaker Renewal	3	3	5	0	2	3	4	4	3	5	315
15	5.4	Conductor renewal	3	3	8	0	2	3	4	4	3	3	310
16	5.4.14/15	Communications and Scada Renewal	2	3	0	2	0	0	6	7	0	4	295
17	4.7.1.3	Provisional Embedded Generation	3	3	0	2	2	0	4	4	2	5	290
18	4.7.1.3	Provisional Connection of Customer Installed Generation	3	3	0	2	2	0	4	4	2	5	290
19	4.7.1.4	Improved Power Factor Correction	4	3	2	6	5	5	0	0	0	3	285
20	4.7.1.4	Reduce Network Distribution Losses	3	3	2	4	5	5	0	0	0	6	275
21	5.4.6	Zone Sub Transformer Renewal	3	3	8	0	2	3	2	2	4	3	265
22	4.7.1.1	Tuai-Gisborne Line Reconductor	2	5	10	1	0	2	0	0	1	1	175
23	4.7.1.2	Provisional Mangapapa Zone Substation	0	2	0	2	2	3	2	2	4	3	175
24	4.7.1.2	Provisional Whangara Zone Substation	0	2	0	2	2	3	2	2	4	3	175
25	4.7.1.1	Provisional Tuai-Gisborne 3rd Transmission Line	0	2	0	2	2	3	2	2	4	3	175
26	4.7.1.2	Provisional Patutahi Sub Capacity Increase	0	2	0	2	2	3	2	2	4	3	175
27	5.4.9	Distribution Transformer Renewal	2	2	6	3	0	0	0	0	2	4	170
28	4.7.1.4	Uneconomic Rural Lines	2	2	7	0	0	1	1	0	6	2	160
29	4.7.1.5	Overhead to Underground conversion	0	3	4	0	0	0	3	3	5	1	160
30	4.7.1.5	Ground fault neutralisers	0	2	4	0	0	0	3	3	4	1	145
31	4.7.1.5	Portable/Emergency Generation	2	1	0	0	0	0	2	3	0	1	125
32	4.7.1.5	Urban rural Automation	1	1	0	0	0	0	3	2	1	1	105
33	4.7.1.4	Improve Load control capability	1	1	2	4	0	0	0	0	0	1	90

## 6.3 Emergency Response Plans

The nature of ENL's business is such that every unplanned supply outage that occurs invokes an emergency response of some degree. In addition there are also unplanned events or incidents that can threaten the safe and continued supply of electricity which prompt an emergency response

Emergency response at a small scale includes the following types of events...

- Part power to one or more premises
- No power to one or more premises
- Third party damage to network assets.
- Property fires

These types of events occur on a daily basis. In any one day 5 to 20 events are typical.

Large scale events that require emergency response to a greater degree include...

- Extreme weather e.g. Wind ,snow, lightning storms
- Earthquake
- Tsunami
- Major flooding

These types of events are relatively rare and occur 4 or 5 times per year to varying degrees.

In these large scale events the normal emergency response strategies become swamped hence additional resources and prioritization is required for effective management of the events.

### **6.3.1 Minor events**

The processes in place for small scale events are as follows...

#### **6.3.1.1 Event Notification**

Notification of the event is obtained...

- When a member of the public calls the call centre.
- When police or emergency services contact the duty control operator.
- When the SCADA system automatically detects an issue and notifies the duty control operator.

#### **6.3.1.2 First Response**

The duty control operator in some cases will carry out remote operations to either isolate the assets affected by event or minimise the effects on other electricity customers.

The call centre or duty control operator directly dispatch fault contractors to the location of the event.

Where possible the first response fault contractor performs the necessary corrective actions.

Where additional personnel or equipment is required the first response fault contractor carry out actions required to ensure the assets are safe and relays all necessary information via the call centre or duty control operator to obtain additional resources.

### **6.3.1.3 Restoration**

Where correction or restoration of supply following an event is beyond the capability of first response contractor's additional staff or contractors are dispatched and the corrective actions are carried out as quickly as possible.

## **6.3.2 Major events**

The processes in place for large scale events are as follows...

### **6.3.2.1 Event Notification**

Notifications of major events are obtained...

- When the call centre receives multiple notifications of unrelated events.
- When police or emergency services contact the duty control operator via civil defence protocols.
- When the SCADA system automatically detects multiple issues and notifies the duty control operator.
- When ENL personnel directly experience an event triggering a personal response. eg Earthquake, power goes off
- When the automatic civil defence notification system advises the General Manager Energy, Asset and Planning Manager or Civil defence liaison directly.
- When the Electricity Commission or System Operator declares an event.

### **6.3.2.2 Event Response**

Where the number or magnitude of events exceeds normal levels the call centre or fault contractors notify the duty control operator. The duty operator makes an assessment and invokes the event actions as necessary. When civil defence protocols are implemented the recipient of the communication in conjunction with the duty control operator invokes the event actions.

For events such as earthquakes ENL personnel and contractors respond without additional notification. In accordance with their personal emergency

action priorities personnel ensure that their own needs and needs of immediate family are met. When the issues in their immediate environment have been addressed the personnel respond to the operational centers. Refer 6.3.2.4 .

### 6.3.2.3 Event Actions

#### 1. Establish control centre.

The duty control operator in conjunction with the civil defence liaison establish the Event management centre. The necessary personnel are notified, normal activities and duties are suspended and emergency roles are activated.

Additional control room staff are activated.

The civil defence liaison attends the civil defence control centre.

A dispatch team is established to group, prioritise and organise the information from the control room staff and call centre. The dispatch team coordinates the contractor resources to the prioritised tasks. The control room staff monitor and record the activities of fault response and repair teams. The General manager Energy oversees activities of the control staff dispatch team and civil defence liaison and provides status information as necessary.

#### 2. Determine Priorities.

If no priorities are identified via the liaison process with Civil Defence, then the sequence of repair is based on the following criteria:

- City areas where large customer numbers are disrupted.
- Critical infrastructure, such as water supplies, sewage systems and hospital / medical facilities, communications facilities.
- Commercial business appropriate to servicing emergency needs. Eg fuel, food
- Rural Townships
- Rural areas:           Between townships  
                                  Spurs – outlying areas

#### 3. Implement Repairs.

Following the allocation of resources first response teams patrol and identify damage to the asset. In addition to land based teams, helicopters are used to carry out patrols, switching, jumper cutting and supply restoration. Damage reports and requirements for corrective action are relayed via control staff to the dispatch team.

First response teams work with the control staff to disconnect, isolate and make safe damaged assets. Where quick repairs are possible eg fuse replacement, these tasks are completed.

Once damaged assets are made safe restoration of supply to unaffected areas is carried out.

Information regarding the requirements for repair or restoration of the damaged assets is communicated by the first response teams to the control staff.

Large repair teams are dispatched with equipment for major repair work, to event locations near job sites. Due to the rugged nature of the terrain in general helicopters are used to drop personnel at the job sites and then follow up a various stages of the work to install poles, restring conductor and return personnel to the vehicles near the event locations. Scheduling of the helicopter work is coordinated by control room staff.

Specialised generator teams are used to move and install generators to remote areas where damaged assets have resulted in isolated areas on spur lines.

#### **4. Allocate resources.**

The dispatch team is notified of resource requirements from the field via the control staff

The team prepares recovery plans and implements the dispatch of resources as required to repair damage.

Equipment and stores providers communicate directly with the dispatch team to establish resource requirements.

The civil defence liaison provides feed back to the dispatch team and updates civil defence plans on the status of new priorities as they are determined.

The dispatch team carries out an on-going reassessment of priorities and planning and applies the available resources to the action timetable.

#### **5. Arrange external resources.**

The information relating to corrective action requirements reported by first response teams is assessed by the General Manager Energy and additional material, equipment and personnel requirements are determined. In general external resource from outside the region is notified of potential around 4 hours into an event. Confirmation of requirements is established with 8 hours and resources typically arrive 8 to 16 hours later. Helicopters are used to collect equipment and materials from outside the region when the delivery time frames by road are excessive.



## **6. Arrange support services.**

A Support services team is established to ensure the needs of emergency personnel are established.

ENL maintains a stock of food and medical supplies sufficient to cater for the short term.

Work hours and fatigue are monitored and recorded by the support team with the information being fed back to the dispatch team.

Communication between field staff and families is coordinated by the support team.

Long term needs are coordinated via the civil defence liaison where necessary.

The chief executive officer is responsible for media updates and public liaison.

### **6.3.2.4 Operational Centres**

#### **1. Primary Site**

The Eastland Network Control Room is located at the 172 Carnarvon Street, Gisborne Facility.

#### **2. Unavailability of the Control Room**

If for any reason the Control Room is unavailable, then the backup Facility will split into the following respective areas as required:

Eastland Network – Wairoa office

Eastland Network – Kaiti Sub Station or Patutahi Sub Station

#### **3. Operational Facilities**

In the event the region is disjoint with respect to access or communications the following remote centres have been designated to enable decentralized planning and operational facilities to ensure for operations to continue at a localized level:

- Eastland Network Wairoa
- Eastland Network Carnarvon St Sub or Kaiti Sub Station
- Eastland Network Tolaga Bay Sub Station
- Eastland Network Tokomaru Bay Sub Station
- Eastland Network Ruatoria Sub Station
- Eastland Network Te Araroa Sub Station
- Eastland Network Puha –Station (Te Karaka - Matawai)

Independent control will be delegated to a person based at each centre to run each area and liaise back to the control centre if communications are available.

In the event that no communications are available, then the local centres will have the ability to operate independently.

### 6.3.3 Contingency measures

A majority of the necessary contingency measures are incorporated into designs of the asset. These contingencies include...

- Redundant or backup protection systems.
- Redundant capacity inherent in conductors and transformers.
- Pre-arranged connection points for portable generation
- Multiple communication methods via ENL's RT network of Third party service providers.
- Paper management systems ready to cover for failure of computer systems.
- Manual operating mechanisms for all assets to backup failure of the SCADA system or auxiliary supply systems.
- Significant battery storage at key locations.

The general approach to contingencies is...

- For failed equipment with a back up inherent in the design, the backup system is used.
- For failed equipment affecting supply the equipment is isolated, or removed to maximise restoration of supply.
- Faulty equipment is replaced with spares held at strategic locations. Spare transformers, switches circuit breakers, protection relays, tap-change equipment and battery systems are held which cover the entire range of equipment used.
- Faulty equipment is bypassed to allow restoration of supply. At rural substations such as Ruatoria, Ngatapa, TeAraroa, Tokomaru, Tolaga, Pehiri, Puha, Blacks Pad and Tahaenui the entire 11kV switchboard can be bypassed and a single set of 100Amp isolation fuses used to provide a temporary supply. Portable generation is used to bypass faulty sections of line and cable enabling restoration to isolated spur assets.

### 6.3.4 Participant Outage Plan

ENL's participant outage plan was prepared in accordance with The Electricity Commission requirements. The plan covers methodology and processes for managing two types of event.

- Class A events - These events evolve over time and occur when a shortfall of energy available for supply is expected. The electricity Commission is responsible for declaring an event. In these events ENL is required to provide a reduction in energy usage based on a comparison with typical/

normal energy usage. This is achieved by operation of the standby diesel generation, shedding of hot-water load via load control for extended periods outside of normal service levels and rolling outages in line with predetermined priorities.

- Immediate (Category B) events – Events that occur with little or no warning, usually as a result of a transmission line or major generation failure. These types of event will generally result in a declaration of a Transmission Grid Emergency. In these events ENL is required to provide a reduction in demand at Grid Exit Points. Depending on the available time frame this is achieved by operation of the standby diesel generation, shedding of load via load control and interruption of load in line with predetermined priorities.

In addition to protect the Transmission System from catastrophic failure following a category B event causing instability an Automatic Under-frequency Load Shedding system is installed (AUFLS) to automatically interrupt supply based on pre-configured priorities.

### **6.3.5 Vulnerable Customers**

A process is in place to accommodate supply interruptions affecting customers with special medical needs.

Where ENL is notified of customers with special needs the customers are advised to prepare an individual emergency plan to ensure their needs can be met should there be an interruption to their supply. Action plans covering short term and long term outages are necessary and issues of battery backup systems or emergency transportation are identified and arranged between the customer and their healthcare provider as these individual emergency plans are developed.

## 7. Funding the business

### 7.1 ENL's business model

ENL's business model is based around the right-hand side of Figure 7.1(a) below.

**Figure 7.1(a) – Customer interface model**

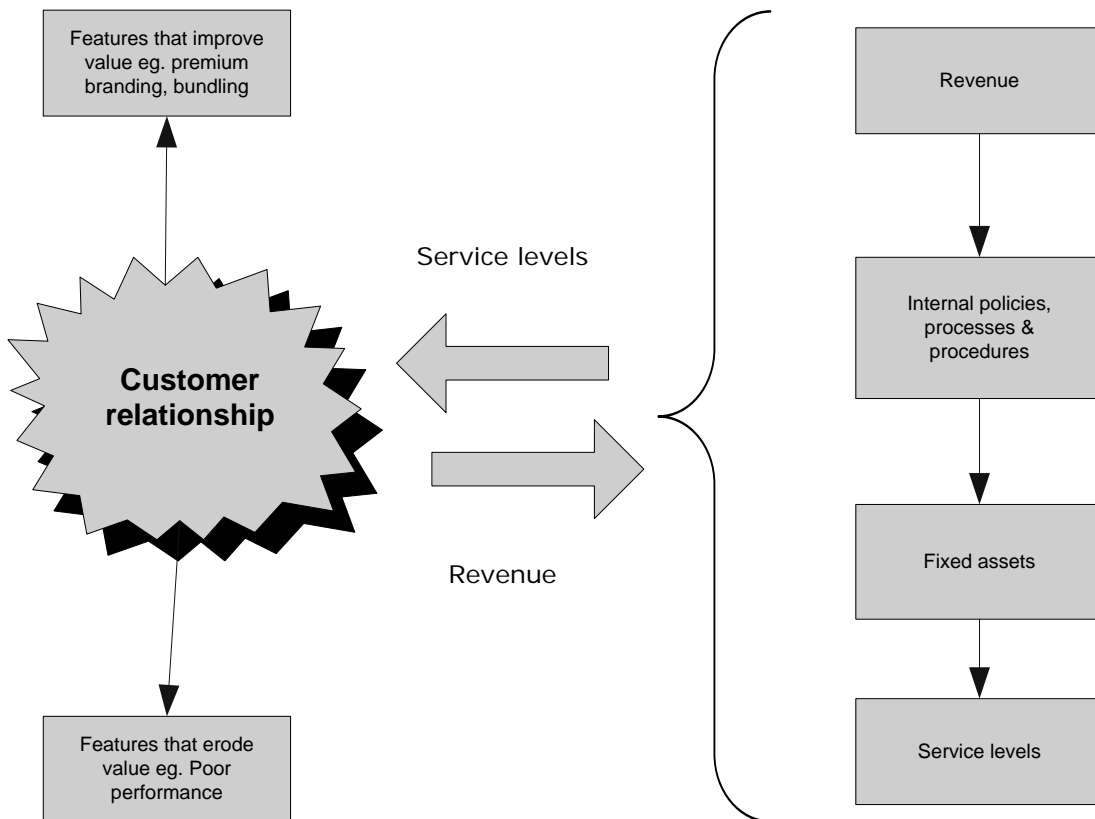

This model shows that ENL receives revenue from its consumers (via the energy retailers who operate on the network) and then, through a wide range of internal processes, policies and plans, ENL converts that cash into fixed assets. These fixed assets in turn create the service levels such as capacity, reliability and security that consumers and other stakeholders want.

### 7.2 Financial Income

ENL's income comes primarily from the energy retailers who pay for conveying energy over ENL's lines. Separately identified in ENL's invoicing of charges is the

pass through transmission costs associated with ENL's connections to the Transpower Grid and Embedded Generators.

Energy retailers present a bundled charge which incorporates transmission, distribution and energy costs through to end user customers.

When determining the level and constituency of its charges, ENL considers the following pricing principles and influences;

### **Revenue Requirements**

Pricing should obtain sufficient revenue for ENL to meet the following requirements;

- Meet its contractual obligations for connection to the Transpower Grid.
- Meet statutory contractual obligations for Distributed Generation
- Meet its contractual obligations for the delivery of energy over its network to the end-consumers.
- Comply with statutory requirements on public safety, environmental protection and quality of supply.
- Provide for new investment.
- Provide a commercially appropriate return on funds to the shareholder.

### **Efficiency**

Pricing must be economically efficient in the investment signals it creates. This is achieved by matching the pricing structure to the cost structure as closely as practical.

### **Even-handedness**

Pricing must be even-handed across different load groups. Specifically:

- The charges to various load groups using the network should vary according to their relative use of different assets.
- Where load groups have different service requirements, service at levels above the common denominator should be charged specifically to the load groups demanding higher levels of service.
- Average costing will be applied where there is common good usage of assets and services within a load group.
- Where new investment is required those users who obtain the benefit should be required to contribute towards the cost.

Pricing must also be even-handed in its treatment of different retailers and provide for equal access as a matter of statutory requirement.

## Simplicity

Pricing must be kept as simple and as administratively efficient as practical. Specifically:

- Transmission charges should be separated from distribution charges.
- ENL should endeavour to ensure distribution costs are relatively stable over time.

## Load Management and Embedded Generation

The pricing methodology should provide signals to encourage customer demand-side participation in load management and investment in embedded generation.

## Regulation

Electricity lines companies are controlled by the requirements of Part 4 of the Commerce Act 1986 and as set out in Commerce Act (Electricity Distribution Price-Quality Path) Determination 2010. This means that ENL is assessed annually against two thresholds:

- i. a price path threshold, which tests whether a lines companies Notional Revenue for the year is less than its Allowable Notional Revenue for that year, using a CPI-X approach to price change; and
- ii. a quality threshold, which tests whether a lines companies network quality (SAIDI and SAIFI) for the year is less than its modified long run averages of quality.

The price path threshold criterion limits the amount which lines business may increase prices each year. Under the regime, prices may only be increased by a factor of CPI-X. From 1 April 2010, a new regulatory period began and an industry wide X factor of 0% was applied to all lines businesses.

Under the price compliance test that will apply from 1 April 2010, a lines company is required to demonstrate that (Current years prices) x (Quantities from 2 years prior) is no greater than (Prior years prices) x (Quantities from 2 years prior) x (CPI-X Adjustment).

Due to delays in completion of Input Methodologies ENL is uncertain about the future pricing requirements.

As with the previous price-quality regime, ENL has concerns over the limits on revenue that are applied under this regime, especially upon a network where consumption and ICP connection growth is static or declining. This is compounded further with an aging network which requires significant levels of on-going maintenance and renewal investment.

However, unlike previous regulation, lines businesses are able to apply to the Commerce Commission for a customized price path which will allow lines businesses to apply a different X-factor to their price path threshold. Lines business will be able to apply for this following release of the Input Methodologies and although this is likely to require a significant amount of work, if a network's return on investment continues to deteriorate, then it may be justified.

## **7.3 Financial Projections**

Financial projections are one of the key outputs of this AMP, representing the financial outcome of the management strategies and specific maintenance, renewal and development plans set out herein. They outline ENL's network expenditure over the planning period, separating capital and maintenance related expenditure.

Note; Summary information as per Disclosure Requirement 7(5) is included on form AM1 in Appendix A2. The Figures relating to the five year forecasts of capital expenditure in appendix A2 are uplifted by a 5% overhead allocation which is allocated to all assets when capitalised, under Eastland Group policy.

Capital expenditure is defined as expenditure that results in increased value of an asset, where the value is defined by service potential (capacity) to derive future benefits, earnings or reduced costs. If extra expenditure, say from an alteration to the original asset, results in extra value after satisfying an independent test on commercial viability, then it is capital expenditure. Overhead to underground conversion, life extension and load driven capacity upgrades fit into this category. Capital expenditure is classified in accordance with the capital expenditure categories as prescribed by the Information Disclosure Requirements 2008.

Maintenance expenditure is defined as expenditure required to operate an asset or keep it in the minimum acceptable serviceable condition needed to continue its earning until the asset has satisfied the life and earning expectations used to establish the commercial viability of the original investment decision. Commercial viability tests will assume a certain level of operating and maintenance expense. Expenditure beyond this level may threaten commercial viability. Sensitivity to this and other risks are weighted into investment decisions. Maintenance expenditure is classified in accordance with the operational expenditure categories as prescribed by the Information Disclosure Requirements 2008.

### **7.3.1 Capital Expenditure**

The Information Disclosure Requirements prescribe Capital Expenditure as being; *"...expenditure on works that, when those works are recognised in the Regulatory Asset Base (RAB), would have the effect of increasing ODV valuation where conducted in accordance with the ODV Handbook..."*

Total capital expenditure over the planning period, as described in Sections 4.0 and 5.0, is \$56.880m. The expenditure profile is relatively flat with an average expenditure of approximately \$5.6 m pa, indicating that steady state assumptions apply. This level of capital expenditure equates to approximately 1.8% of the asset replacement cost and based on the 2011 Information Disclosure statistics is below the industry average of 3.22%.

Capital expenditure forecasts for the planning period are provided by asset type and expenditure category in accordance with the Information Disclosure requirements. Comments on the categories of expenditure are made below.

### **Customer Connection**

*“Capital expenditure primarily associated with the connection of new consumers to the network or alterations to the connections of existing consumers, where the expenditure relates to connection assets and/or parts of the network for which expenditure is recoverable in total, or in part, by a contribution from those new consumer(s).”*

Where assets are required to be installed to facilitate a new, upgraded or altered customer connection it is ENL policy that cost responsibility resides with the customer. Accordingly the majority of Customer Connection expenditure is funded by customers who engage directly with ENL authorised contractors to carry out the required work with the ownership of network type assets being vested to ENL upon completion.

For the planning period the total \$900k Customer Connection expenditure is 1.6% of the total capital expenditure forecast for the period. This unplanned expenditure allowance is based on historical actual spend associated with the provision of new or upgraded assets which cannot be reasonably expected to be met by the customer. Customer connection expenditure directly with contractors is not included in the forecast amounts.

### **System Growth**

*“... capital expenditure primarily associated with a change in demand on the network assets, where the expenditure is not recoverable in total, or in part, through a contribution from the consumer(s) that is (are) responsible for the change in demand.”*

For the planning period the total \$11.1m System Growth expenditure is 20% of the total capital expenditure forecast for the period.

This category of expenditure includes provision for the steady state customer driven network extension and capacity upgrades that cannot be avoided. The only major projects included are those where the upgrade triggers are currently exceeded. Trigger levels for growth upgrades predicted are described in Section 5.5.

A key feature of these projections is that while the AMP attempts to predict the impact of growth on network development, probable timings, etc. these issues



are excluded from financial planning until more certainty on size and location and optimum response is evident.

### **Asset Replacement and Renewal**

*"..capital expenditure primarily associated with the progressive physical deterioration of the condition of network assets or their immediate surrounds or expenditure arising as result of the obsolescence of network assets."*

Asset Replacement driven capital expenditure for the planning period averages \$4.27m p.a., and is \$42.7m in total. It equates to 75% of the total capital expenditure forecast for the period. This category of expenditure per asset type is described in Section 5.4,

The predominance of this category of capital expenditure in the total expenditure for the period reflects the increasing average age of network assets, (especially poles and conductor) and that many assets are in the age replacement phase of their life cycle. Asset Replacement expenditure is predominantly funded by depreciation. The forecast depreciation for 2012/2013 is \$4.3M

A previous issue regarding a "gap" between the failure and renewal rate of 11kV poles has been addressed by increasing the pole renewal budget to match the 10 year replacement rate.

An 8km pa "gap" between the 10 year renewal rate and targeted renewal rate for 11kV conductor remains. It is expected that this "gap", (which equates to \$500k pa) will be mitigated through the planned age extension/value reduction of uneconomic network segments and increased forecasted maintenance expenditure. Also performance to date indicates that the actual life of conductor is much greater than that forecast. It is not expected that the conductor renewal "gap" will unduly affect the achievement of levels of operational performance required by regulation or expected by customers.

### **Reliability, Safety and Environment.**

*"..capital expenditure primarily associated with maintaining or improving the safety of the network for customers, employees and the public; expenditure primarily associated with the improvement of reliability or service standards; and expenditure primarily associated with meeting new or enhanced environmental requirements."*

Reliability, Safety and Environment driven capital expenditure for the planning period is \$1.75m and equates to 3% of the total capital expenditure forecast for the period.

This relatively low level of expenditure in this category is a result of large levels of expenditure that was undertaken between 2000 and 2004 for the purposes of

addressing a backlog of safety and environmental issues and improvement of security of supply standards through the development of the sub-transmission network.

It should also be noted that a consequence of ENL's significant asset renewal program is an improvement in reliability, safety and environmental performance hence dedicated expenditure in these areas is not generally required.

### **Asset Relocation.**

*"...capital expenditure primarily associated with the need to move assets. This normally results from local authority or Transit road widening projects. Accordingly this category of expenditure is to be used where the cost of moving assets is other than for reasons of routine maintenance, refurbishment and renewal maintenance or fault emergency maintenance."*

Asset Relocation driven capital expenditure for the planning period is an annual unplanned allowance of \$50k pa based on historical actual spend. Territorial authorities operating in ENL's network coverage area have been canvassed on a regular basis for information on immediate future and longer term requirements they might have regarding the relocation of ENL assets. Responses indicate that the processes used by the authorities do not include forward planning for asset relocations beyond the immediate financial year. In fact assets requiring relocation are generally not identified until projects have commenced. Asset Relocation capital expenditure equates to 1% of the total capital expenditure forecast for the period.

### **Overhead to Underground Conversions**

With reference to previous sections 5.4.2 and 5.4.3, for the planning period total of \$1.9m is forecast for overhead to underground conversions.

Of this amount in the years 2011/12, 2012/13, 2013/14, 2014/2015, 2017/18, 2018/19, 2019/20 and 2020/21 \$150k pa is budgeted in the category of Asset Replacement and Renewal for the conversion of 400V reticulation, (1km pa) to underground.

In the years 2015/16 and 2016/17 \$350pa is budgeted in the category of Reliability, Safety and Environment for the conversion of 11kV reticulation to underground in streets on the fringe of the Gisborne CBD.

The following tables and graphs present the forecast expenditure as per the categorisation above, in summary by asset type and in full.

Eastland Network Limited

Budget - April 2012 to March 2013

Capital Expenditure Projections 2012/13 - 2021/22

Description	Planned/ Unplanned	Info Disclosure Category	2012/13	2013/14	2014/15	2015/16	2016/17	2017/18	2018/19	2019/20	2020/21	2021/22	TOTAL
			5,588,000	5,713,000	5,718,000	5,718,000	6,318,000	6,278,000	5,733,000	5,418,000	5,438,000	4,958,000	56,880,000
<b>Sub transmission Lines and Cables</b>													
Replacement 80 poles pa to 2014, then 60 poles pa	Planned	Asset Replacement & Renewal	400000	300000	300000	300000	300000	300000	300000	300000	300000	400000	3,200,000
Fault Replacement Line	Unplanned	Asset Replacement & Renewal	40000	40000	40000	40000	40000	40000	40000	40000	40000	40000	400,000
Mahia 33kV line extension and Substation (defer from 2011)	Planned	System Growth	450000	450000									900,000
Wairoa Development (GXP to North Clyde)	Planned	System Growth			300000	300000	300000	300000					1,200,000
			890000	790000	640000	640000	640000	640000	340000	340000	340000	440000	5,700,000
<b>11kV Lines and Cables</b>													
Conductor replacement Coast; 3km to 2016 then 6km	Planned	Asset Replacement & Renewal	120000	120000	120000	120000	240000	240000	240000	240000	240000	240000	1,920,000
Conductor replacement Gisborne, 3km to 2016 then 6km	Planned	Asset Replacement & Renewal	120000	120000	120000	120000	240000	240000	240000	240000	240000	240000	1,920,000
Conductor replacement Wairoa, 3km to 2016 then 6km	Planned	Asset Replacement & Renewal	120000	120000	120000	120000	240000	240000	240000	240000	240000	240000	1,920,000
Network Line Extension/Upgrade/Fault Replacement (unplanned 1km)	Unplanned	System Growth	90000	90000	90000	90000	90000	90000	90000	90000	90000	90000	900,000
Replacement 365 poles per year, GIS	Planned	Asset Replacement & Renewal	1100000	1100000	1100000	1100000	1100000	1100000	1100000	1100000	1100000	1100000	11,000,000
Replacement 205 poles per year, WOA	Planned	Asset Replacement & Renewal	600000	600000	600000	600000	600000	600000	600000	600000	600000	600000	6,000,000
Replacement 30 poles (fault & premature failure)	Unplanned	Asset Replacement & Renewal	100000	100000	100000	100000	100000	100000	100000	100000	100000	100000	1,000,000
Network Cable Extension/Upgrade/Replacement (unplanned, 0.5km)	Unplanned	System Growth	100000	100000	100000	100000	100000	100000	100000	100000	100000	100000	1,000,000
Cable replacement, (fault, premature failure & rationalisation, 0.5km)	Unplanned	Asset Replacement & Renewal	100000	100000	100000	100000	100000	100000	100000	100000	100000	100000	1,000,000
Hirini St to Weigh bridge 370m	Planned	System Growth									80000		80,000
Mahia V reg replacement	Planned	Asset Replacement & Renewal	50000										50,000
Cable Plunket - Ormond Rd	Planned	System Growth							100000				100,000
Dalton feeder Moana Rd bypass	Planned	System Growth					240000						240,000
Ngatapa to Otoko Hill 8km (underbuild 50kV)	Planned	System Growth		250000									250,000
Cable City Feeder (Pak n Save) 0.5km	Planned	System Growth								140000			140,000
Cable Kahutia Street feeder 1.1km	Planned	System Growth							275000				275,000
Port feeder link	Planned	Reliability, Safety & Environment			90000								90,000
Wainui Link, Sponge Bay - Llyod George	Planned	System Growth				135000							135,000
Stanley Rd Link, ANZAC/Innes - Awapuni	Planned	System Growth			150000								150,000
CBD UG Project (Stg1 Childers, Grey Streets)	Planned	Reliability, Safety & Environment						350000					350,000
CBD UG Project (Stg2 Roebuck, Disrallei Streets)	Planned	Reliability, Safety & Environment					350000						350,000

Asset relocations (for Territorial authorities)	Unplanned	Asset Relocations	50000	50000	50000	50000	50000	50000	50000	50000	50000	50000	500,000
			<b>2550000</b>	<b>2750000</b>	<b>2740000</b>	<b>2635000</b>	<b>3450000</b>	<b>3210000</b>	<b>3235000</b>	<b>3000000</b>	<b>2940000</b>	<b>2860000</b>	<b>29,370,000</b>
<b>LT Lines and Cables</b>													
Pole replacement 100 per year	Planned	Asset Replacement & Renewal	200000	200000	200000	200000	200000	200000	200000	200000	200000	200000	2,000,000
Line Replacement with Underground 1km	Planned	Asset Replacement & Renewal	150000	150000	150000	150000	0	0	150000	150000	150000	150000	1,200,000
Unplanned Network Extension/Upgrade/Replacement Line 1km	Unplanned	System Growth	40000	40000	40000	40000	40000	40000	40000	40000	40000	40000	400,000
Allowance for Growth/Upgrade, Cables 1km	Unplanned	System Growth	80000	80000	80000	80000	80000	80000	80000	80000	80000	80000	800,000
Cable replacement, (fault, premature failure & rationalisation, 1km)	Unplanned	Asset Replacement & Renewal	80000	80000	80000	80000	80000	80000	80000	80000	80000	80000	800,000
			<b>550000</b>	<b>550000</b>	<b>550000</b>	<b>550000</b>	<b>400000</b>	<b>400000</b>	<b>550000</b>	<b>550000</b>	<b>550000</b>	<b>550000</b>	<b>5,200,000</b>
<b>Service Connections</b>													
New Service Fuse Boxes to Replace Meter Box Sharing 50pa	Planned	Reliability, Safety & Environment	30000	30000	30000	30000	30000	30000	30000	30000	30000	30000	300,000
Meter Bd install associated with Glv box removal 50pa.	Planned	Reliability, Safety & Environment	25000	25000	25000	25000	25000	25000	25000	25000	25000	25000	250,000
Service Pillar Replacement (40 a to 2014 then 20pa)	Planned	Asset Replacement & Renewal	40000	40000	20000	20000	20000	20000	20000	20000	20000	20000	240,000
			<b>95000</b>	<b>95000</b>	<b>75000</b>	<b>75000</b>	<b>75000</b>	<b>75000</b>	<b>75000</b>	<b>75000</b>	<b>75000</b>	<b>75000</b>	<b>790,000</b>
<b>Load Control</b>													
Replace failed ripple relays	Planned	Asset Replacement & Renewal	10000	10000	10000	10000	10000	10000	10000	10000	10000	10000	100,000
Provide ripple relays for new connections	Unplanned	Customer Connection	10000	10000	10000	10000	10000	10000	10000	10000	10000	10000	100,000
Upgrade Wairoa pilot control system	Planned	Asset Replacement & Renewal	25000	25000	25000								75,000
Install second Injection Point Gisborne (11kV)	Planned	System Growth				250000	250000						500,000
			<b>45000</b>	<b>45000</b>	<b>45000</b>	<b>270000</b>	<b>270000</b>	<b>20000</b>	<b>20000</b>	<b>20000</b>	<b>20000</b>	<b>20000</b>	<b>775,000</b>
<b>Zone Substations</b>													
New zone Sub Tatapour/Whangara 2.5MVA	Planned	System Growth								450000	450000		900,000
New zone Sub Massey Road	Planned	System Growth						450000	450000				900,000
Building/Switchyard Security Upgrade (Kaiti)	Planned	Reliability, Safety & Environment	50000	10000	10000	10000	10000	10000	10000	10000	10000		130,000
Replace T1 Patutahi 5MVA	Planned	Asset Replacement & Renewal			350000	350000							700,000
Replace T1 Tolaga 2.5MVA	Planned	Asset Replacement & Renewal					500000						500,000
Replace 11kV CB trucks & protection Carnarvon St	Planned	Asset Replacement & Renewal		260000	120000								380,000
Replace Puha T1 5MVA	Planned	Asset Replacement & Renewal						500000					500,000
Earthing Upgrades (step potential)	Planned	Asset Replacement & Renewal										10000	10,000
			<b>50000</b>	<b>270000</b>	<b>480000</b>	<b>360000</b>	<b>510000</b>	<b>960000</b>	<b>460000</b>	<b>460000</b>	<b>460000</b>	<b>10000</b>	<b>4,020,000</b>
<b>50kV CB's</b>													
Makaraka Line to Patutahi	Planned	Asset Replacement & Renewal							80000				80,000

Ruatoria T1, Toko T1, Ruatoria T1 purchase/setup	Planned	Asset Replacement & Renewal	120000										120,000
Ruatoria T1, Toko T1, Ruatoria T1 install	Planned	Asset Replacement & Renewal	120000										120,000
Carnarvon T1	Planned	Asset Replacement & Renewal							80000				80,000
			120000	120000	0	0	0	0	80000	0	80000	0	400,000
<b>11kV CB's (Rural Automation)</b>													
Field Recloser Automation Plan - replacements	Planned	Asset Replacement & Renewal	25000	25000	25000	25000	25000	25000	25000	25000			125,000
Field Recloser Automation Plan - additions	Planned	Reliability, Safety & Environment	25000	25000	25000	25000	25000	25000	25000	25000	25000	25000	125,000
			25000	25000	25000	25000	25000	25000	25000	25000	25000	25000	225,000
<b>Distribution Transformers</b>													
Replace Transformers <100kVA	Planned	Asset Replacement & Renewal	100000	100000	100000	100000	100000	100000	100000	100000	100000	100000	1,000,000
Replace Transformers >100kVA	Planned	Asset Replacement & Renewal	255000	255000	255000	255000	255000	255000	255000	255000	255000	255000	2,550,000
Transformers Growth <100kVA	Unplanned	System Growth	78000	78000	78000	78000	78000	78000	78000	78000	78000	78000	780,000
Transformers Growth >100kVA	Unplanned	System Growth	140000	140000	140000	140000	140000	140000	140000	140000	140000	140000	1,400,000
			573000	573000	573000	573000	573000	573000	573000	573000	573000	573000	5,730,000
<b>Pole Mounted Isolation Equipment</b>													
Age Replacement of 11kV ABS's	Planned	Asset Replacement & Renewal	100000	100000	100000	100000	100000	100000	100000	100000	100000	100000	1,000,000
11kV Fuse replacement 30 sets	Planned	Asset Replacement & Renewal	40000	40000	40000	40000	40000	40000	40000	40000	40000	40000	400,000
			140000	140000	140000	140000	140000	140000	140000	140000	140000	140000	1,400,000
<b>11kV Ground Mounted Switchgear</b>													
New Connections	Unplanned	Customer Connection	40000	40000	40000	40000	40000	40000	40000	40000	40000	40000	400,000
"A" Park Wairoa, switchgear addition/alteration	Planned	Reliability, Safety & Environment	75000										75,000
Switchgear Replacement plan	Planned	Asset Replacement & Renewal	50000	50000	50000	50000	50000	50000	50000	50000	50000	50000	450,000
			165000	90000	90000	90000	90000	90000	90000	90000	90000	90000	885,000
<b>LV Switchgear</b>													
Replace LV Link Pillars (6 boxes p.a.)	Planned	Asset Replacement & Renewal	40000	40000	40000	40000	40000	40000	40000	40000	40000	40000	400,000
LV SW/GR Allowance for New Installations	Unplanned	Customer Connection	40000	40000	40000	40000	40000	40000	40000	40000	40000	40000	400,000
			80000	80000	80000	80000	80000	80000	80000	80000	80000	80000	800,000
<b>Control and Protection</b>													
Replace Batteries / Charges	Unplanned	Asset Replacement & Renewal	20000	20000	20000	20000	20000	20000	20000	20000	20000	20000	200,000
Allowance for failure	Unplanned	Asset Replacement & Renewal	10000	10000	10000	10000	10000	10000	10000	10000	10000	10000	100,000
Replace 11kV protection (Kaiti & Parkinson)	Planned	Asset Replacement & Renewal	80000	80000									160,000
			110000	110000	30000	30000	30000	30000	30000	30000	30000	30000	460,000

## Communications

Replace "backbone" Links & 13 repeaters	Planned	Asset Replacement & Renewal	120000	65000	65000									250,000
Replace Generator Carnarvon St	Planned	Asset Replacement & Renewal										30000		30,000
Unplanned Equipment Replacements (fault & premature failure)	Unplanned	Asset Replacement & Renewal	20000	20000	20000	20000	20000	20000	20000	20000	20000	20000	20000	200,000
Replace Vehicle RTs	Planned	Asset Replacement & Renewal		150000	150000									300,000
			<b>140000</b>	<b>20000</b>	<b>235000</b>	<b>235000</b>	<b>20000</b>	<b>20000</b>	<b>20000</b>	<b>20000</b>	<b>20000</b>	<b>50000</b>		<b>780,000</b>

## SCADA

Master Station Development	Planned	Reliability, Safety & Environment	10000	10000										20,000
Unscheduled RTU Replacement	Unplanned	Asset Replacement & Renewal	10000	10000	10000	10000	10000	10000	10000	10000	10000	10000	10000	100,000
			<b>20000</b>	<b>20000</b>	<b>10000</b>	<b>10000</b>	<b>10000</b>	<b>10000</b>	<b>10000</b>	<b>10000</b>	<b>10000</b>	<b>10000</b>	<b>10000</b>	<b>120,000</b>

## General

Test Instrument & Safety Equipment, Additional/Upgrade	Planned	Asset Replacement & Renewal	5000	5000	5000	5000	5000	5000	5000	5000	5000	5000	5000	50,000
Establish 2x Genset sites (Raupunga & Ruakituri)	Planned	Reliability, Safety & Environment	30000	30000										60,000
			<b>35000</b>	<b>35000</b>	<b>5000</b>	<b>5000</b>	<b>5000</b>	<b>5000</b>	<b>5000</b>	<b>5000</b>	<b>5000</b>	<b>5000</b>	<b>5000</b>	<b>110,000</b>

TOTAL NETWORK CAPEX			<b>5,588,000</b>	<b>5,713,000</b>	<b>5,718,000</b>	<b>5,718,000</b>	<b>6,318,000</b>	<b>6,278,000</b>	<b>5,733,000</b>	<b>5,418,000</b>	<b>5,438,000</b>	<b>4,958,000</b>		<b>56,880,000</b>
---------------------	--	--	------------------	------------------	------------------	------------------	------------------	------------------	------------------	------------------	------------------	------------------	--	-------------------

												<b>TOTAL</b>	
			<b>2012/13</b>	<b>2013/14</b>	<b>2014/15</b>	<b>2015/16</b>	<b>2016/17</b>	<b>2017/18</b>	<b>2018/19</b>	<b>2019/20</b>	<b>2020/21</b>	<b>2021/22</b>	<b>2012/22</b>

## Summary By Capital Expenditure Category

Planned	Customer Connection	0	0	0	0	0	0	0	0	0	0	0	0	0
Unplanned	Customer Connection	90,000	90,000	90,000	90,000	90,000	90,000	90,000	90,000	90,000	90,000	90,000	90,000	900,000
<b>Total</b>	<b>Customer Connection</b>	<b>90,000</b>	<b>90,000</b>	<b>90,000</b>	<b>90,000</b>	<b>90,000</b>	<b>90,000</b>	<b>90,000</b>	<b>90,000</b>	<b>90,000</b>	<b>90,000</b>	<b>90,000</b>	<b>90,000</b>	<b>900,000</b>
<b>0</b>														
Planned	System Growth	450,000	700,000	450,000	685,000	790,000	750,000	825,000	590,000	530,000	0	0	0	5,770,000
Unplanned	System Growth	528,000	528,000	528,000	528,000	528,000	528,000	528,000	528,000	528,000	528,000	528,000	528,000	5,280,000
<b>Total</b>	<b>System Growth</b>	<b>978,000</b>	<b>1,228,000</b>	<b>978,000</b>	<b>1,213,000</b>	<b>1,318,000</b>	<b>1,278,000</b>	<b>1,353,000</b>	<b>1,118,000</b>	<b>1,058,000</b>	<b>528,000</b>	<b>528,000</b>	<b>528,000</b>	<b>11,050,000</b>
<b>0</b>														
Planned	Asset Replacement & Renewal	3,870,000	3,835,000	4,065,000	3,895,000	4,065,000	4,040,000	3,795,000	3,690,000	3,795,000	3,830,000	3,830,000	3,830,000	38,880,000
Unplanned	Asset Replacement & Renewal	380,000	380,000	380,000	380,000	380,000	380,000	380,000	380,000	380,000	380,000	380,000	380,000	3,800,000

<b>Total</b>	<b>Asset Replacement &amp; Renewal</b>	4,250,000	4,215,000	4,445,000	4,275,000	4,445,000	4,420,000	4,175,000	4,070,000	4,175,000	4,210,000	42,680,000
												0
Planned	Reliability, Safety & Environment	220,000	130,000	155,000	90,000	415,000	440,000	65,000	90,000	65,000	80,000	1,750,000
Unplanned	Reliability, Safety & Environment	0	0	0	0	0	0	0	0	0	0	0
<b>Total</b>	<b>Reliability, Safety &amp; Environment</b>	<b>220,000</b>	<b>130,000</b>	<b>155,000</b>	<b>90,000</b>	<b>415,000</b>	<b>440,000</b>	<b>65,000</b>	<b>90,000</b>	<b>65,000</b>	<b>80,000</b>	<b>1,750,000</b>
												0
Planned	Asset Relocations	0	0	0	0	0	0	0	0	0	0	0
Unplanned	Asset Relocations	50,000	50,000	50,000	50,000	50,000	50,000	50,000	50,000	50,000	50,000	500,000
<b>Total</b>	<b>Asset Relocations</b>	<b>50,000</b>	<b>50,000</b>	<b>50,000</b>	<b>50,000</b>	<b>50,000</b>	<b>50,000</b>	<b>50,000</b>	<b>50,000</b>	<b>50,000</b>	<b>50,000</b>	<b>500,000</b>
												0
<b>TOTAL NETWORK CAPEX</b>		<b>5,588,000</b>	<b>5,713,000</b>	<b>5,718,000</b>	<b>5,718,000</b>	<b>6,318,000</b>	<b>6,278,000</b>	<b>5,733,000</b>	<b>5,418,000</b>	<b>5,438,000</b>	<b>4,958,000</b>	<b>56,880,000</b>
	<b>Total Planned</b>	<b>4,540,000</b>	<b>4,665,000</b>	<b>4,670,000</b>	<b>4,670,000</b>	<b>5,270,000</b>	<b>5,230,000</b>	<b>4,685,000</b>	<b>4,370,000</b>	<b>4,390,000</b>	<b>3,910,000</b>	<b>46,400,000</b>
	<b>Total Unplanned</b>	<b>1,048,000</b>	<b>1,048,000</b>	<b>1,048,000</b>	<b>1,048,000</b>	<b>1,048,000</b>	<b>1,048,000</b>	<b>1,048,000</b>	<b>1,048,000</b>	<b>1,048,000</b>	<b>1,048,000</b>	<b>10,480,000</b>
<b>TOTAL NETWORK CAPEX</b>		<b>5,588,000</b>	<b>5,713,000</b>	<b>5,718,000</b>	<b>5,718,000</b>	<b>6,318,000</b>	<b>6,278,000</b>	<b>5,733,000</b>	<b>5,418,000</b>	<b>5,438,000</b>	<b>4,958,000</b>	<b>56,880,000</b>
<b>Total Overhead to Underground Conversions</b>		<b>150,000</b>	<b>150,000</b>	<b>150,000</b>	<b>150,000</b>	<b>350,000</b>	<b>350,000</b>	<b>150,000</b>	<b>150,000</b>	<b>150,000</b>	<b>150,000</b>	<b>1,750,000</b>

**Summary of Network Capital Expenditure by Asset Group**

	2012/13	2013/14	2014/15	2015/16	2016/17	2017/18	2018/19	2019/20	2020/21	2021/22	TOTAL
Sub transmission Lines and Cables	890,000	790,000	640,000	640,000	640,000	640,000	340,000	340,000	340,000	440,000	5,700,000
11kV Lines and Cables	2,550,000	2,750,000	2,740,000	2,635,000	3,450,000	3,210,000	3,235,000	3,000,000	2,940,000	2,860,000	29,370,000
LT Lines and Cables	550,000	550,000	550,000	550,000	400,000	400,000	550,000	550,000	550,000	550,000	5,200,000
Service Connections	95,000	95,000	75,000	75,000	75,000	75,000	75,000	75,000	75,000	75,000	790,000
Load Control	45,000	45,000	45,000	270,000	270,000	20,000	20,000	20,000	20,000	20,000	775,000
Zone Substations	50,000	270,000	480,000	360,000	510,000	960,000	460,000	460,000	460,000	10,000	4,020,000
50kV CB's	120,000	120,000	0	0	0	0	80,000	0	80,000	0	400,000
11kV CB's (Rural Automation)	25,000	25,000	25,000	25,000	25,000	25,000	25,000	25,000	25,000	25,000	250,000
Distribution Transformers	573,000	573,000	573,000	573,000	573,000	573,000	573,000	573,000	573,000	573,000	5,730,000
Pole Mounted Isolation Equipment	140,000	140,000	140,000	140,000	140,000	140,000	140,000	140,000	140,000	140,000	1,400,000
11kV Ground Mounted Switchgear	165,000	90,000	90,000	90,000	90,000	90,000	90,000	90,000	90,000	90,000	975,000
LV Switchgear	80,000	80,000	80,000	80,000	80,000	80,000	80,000	80,000	80,000	80,000	800,000
Control and Protection	110,000	110,000	30,000	30,000	30,000	30,000	30,000	30,000	30,000	30,000	460,000
Communications	140,000	20,000	235,000	235,000	20,000	20,000	20,000	20,000	20,000	50,000	780,000

SCADA	20,000	20,000	10,000	10,000	10,000	10,000	10,000	10,000	10,000	10,000	10,000	120,000
General	35,000	35,000	5,000	5,000	5,000	5,000	5,000	5,000	5,000	5,000	5,000	110,000
<b>TOTAL NETWORK CAPEX</b>	<b>5,588,000</b>	<b>5,713,000</b>	<b>5,718,000</b>	<b>5,718,000</b>	<b>6,318,000</b>	<b>6,278,000</b>	<b>5,733,000</b>	<b>5,418,000</b>	<b>5,438,000</b>	<b>4,958,000</b>		<b>56,880,000</b>



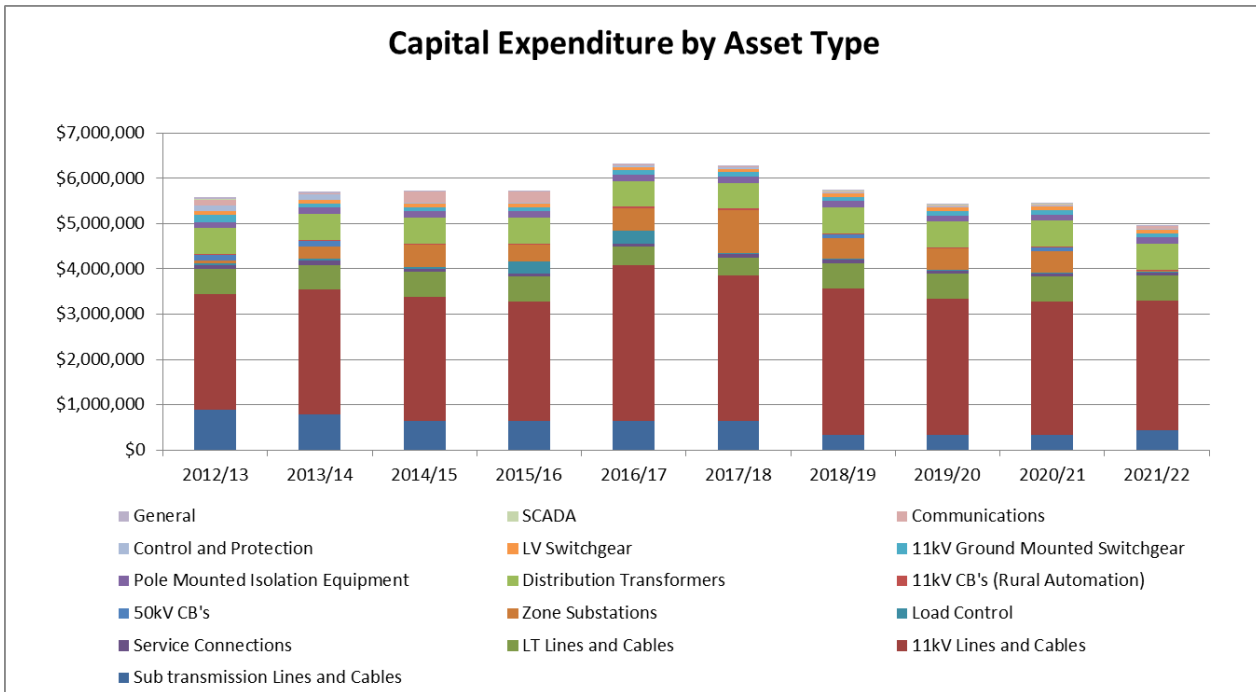
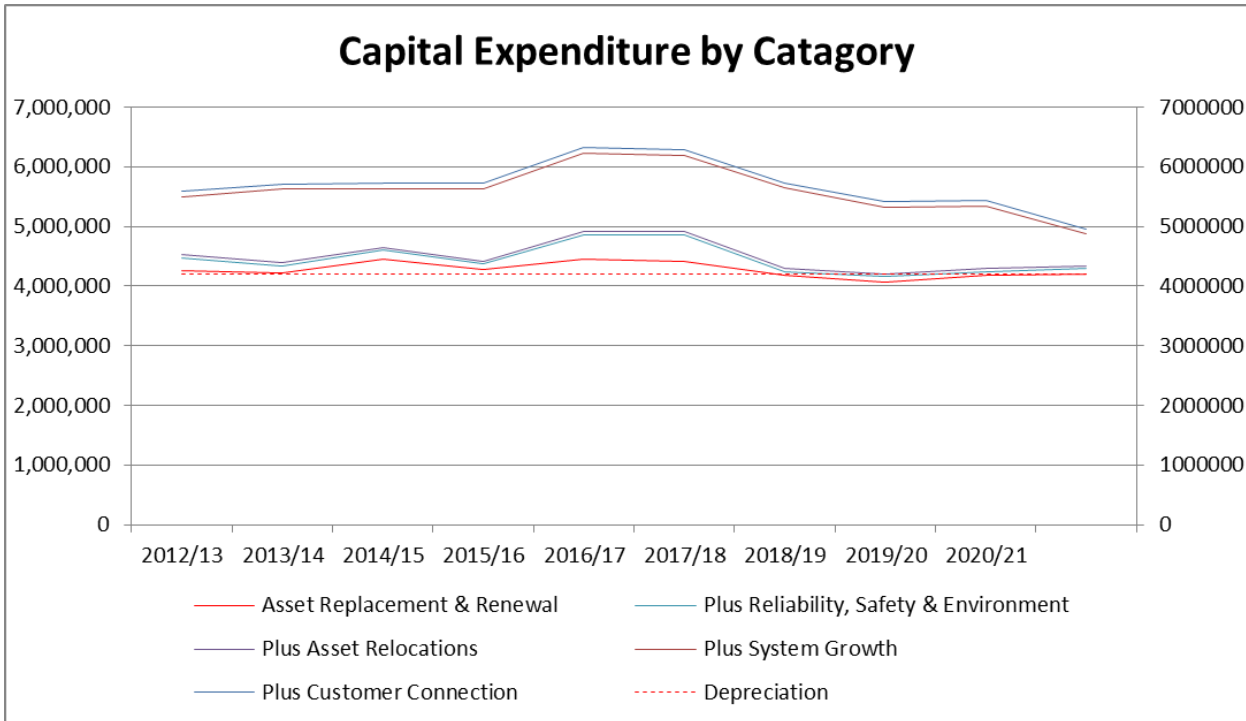

**7.3.2 Maintenance expenditure**

Total maintenance expenditure over the planning period, as described in Section 5.3, is \$28.837m. The expenditure profile is flat with forecast annual expenditure of \$2.883m. This level of expenditure indicates that steady state assumptions apply.

As described in Section 2.3, it has been identified that ENL's distribution assets are in the age replacement phase of their life cycle. The management tactic is to therefore replace rather than to continue with a heavy maintenance strategy. The expected improvement in average asset condition will lift performance and allows low maintenance expenditure to be sustained.

Maintenance expenditure forecasts for the planning period are provided by asset type and expenditure category in accordance with the Information Disclosure requirements. General comments on the categories of expenditure are made below.

### **Routine and Preventative Maintenance**

*"... expenditure that is driven by pre-planned and programmed work schedules. This activity should not include reactive or emergency expenditure but should include fault rectification works that are undertaken at a time or date subsequent to the initial fault response and restoration activities. This activity should include routine inspection, testing and vegetation management activities."*

For the planning period the total \$15.669m Routine and Preventative expenditure is 54% of the total capital expenditure forecast for the period.

### **Fault and Emergency Maintenance**

*"... expenditure that is driven by an unplanned instantaneous event that impacts the satisfactory operation of network assets. The activities should occur as a reaction to an unplanned instantaneous event and should not include activities performed proactively to mitigate the impact such an event would have should it occur."*

For the planning period the total \$10.368m Fault and Emergency expenditure is 36% of the total maintenance expenditure forecast for the period. As described in section 5.3.1 included in this expenditure category is a standing allowance of \$273k pa for provision of a faults call centre and a fault management service.

### **Refurbishment and Renewal Maintenance**

*"... expenditure associated with the replacement, refurbishment and/or renewal of items that are component parts of an asset, as described in the ODV handbook."*

For the planning period the total \$2.8m Refurbishment and Renewal expenditure is 10% of the total maintenance expenditure forecast for the period.

The following tables and graphs present the forecast expenditure as per the categorisation above, in summary by asset type and in full.

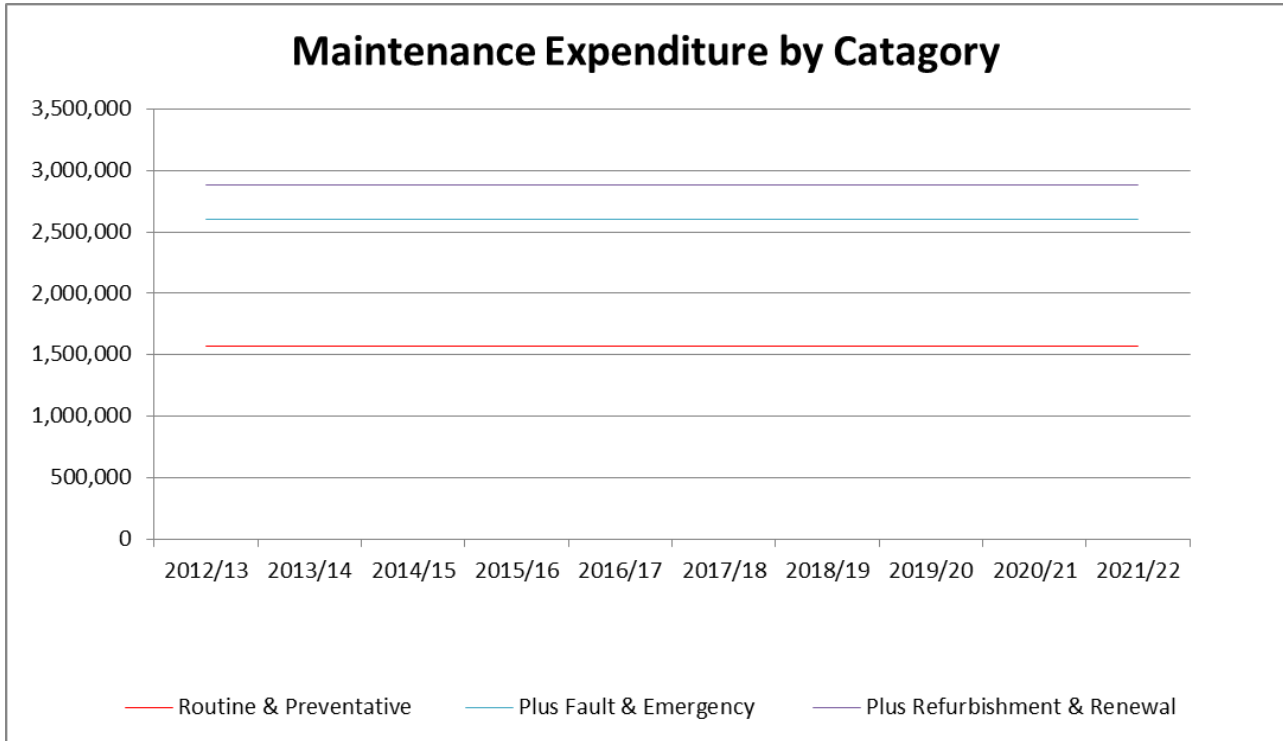

Eastland Network Limited

Budget - April 2012 to March 2013

Maintenance Expenditure Projections 2012/13 to 2021/22

Description	Planned / Unplanned	Info Disclosure Op Expend Category	Quantity	Rate	Planned Cost	Unplanned Cost	2012/13	2013/14	2014/15	2015/16	2016/17	2017/18	2018/19	2019/20	2020/21	2021/22	Total
							2,883,752	2,883,752	2,883,752	2,883,752	2,883,752	2,883,752	2,883,752	2,883,752	2,883,752	2,883,752	2,883,752
<b>Sub-transmission Lines</b>																	
50kV Patrols (Ground & Helicopter)	Planned Actions	Routine & Preventative	2,000	12	24,000		24,000	24,000	24,000	24,000	24,000	24,000	24,000	24,000	24,000	24,000	240,000
50kv Inspections (Climbing)	Planned Actions	Routine & Preventative	135	150	20,000		20,000	20,000	20,000	20,000	20,000	20,000	20,000	20,000	20,000	20,000	200,000
50kV Testing - Ultrasound scan (Poles)	Planned Actions	Routine & Preventative	200	50	10,000		10,000	10,000	10,000	10,000	10,000	10,000	10,000	10,000	10,000	10,000	100,000
50kv Defect / Fault repairs	Unplanned Actions	Fault & Emergency	2	6,250		12,500	12,500	12,500	12,500	12,500	12,500	12,500	12,500	12,500	12,500	12,500	125,000
50kV Fault response (incl Helicopter)	Unplanned Actions	Fault & Emergency	5	4,000		20,000	20,000	20,000	20,000	20,000	20,000	20,000	20,000	20,000	20,000	20,000	200,000
50kV Radio Interference correction	Unplanned Actions	Fault & Emergency	3	2,000		6,000	6,000	6,000	6,000	6,000	6,000	6,000	6,000	6,000	6,000	6,000	60,000
50kV Pole component replacement/maint	Planned Actions	Refurbishment & Renewal	60	1,000	50,000		50,000	50,000	50,000	50,000	50,000	50,000	50,000	50,000	50,000	50,000	500,000
50kV Faults Management	Planned Actions	Fault & Emergency			20,000		20,000	20,000	20,000	20,000	20,000	20,000	20,000	20,000	20,000	20,000	200,000
<b>50kV Lines</b>					<b>124,000</b>	<b>38,500</b>	<b>162,500</b>	<b>162,500</b>	<b>162,500</b>	<b>162,500</b>	<b>162,500</b>	<b>162,500</b>	<b>162,500</b>	<b>162,500</b>	<b>162,500</b>	<b>162,500</b>	<b>1,625,000</b>
<b>11kV Lines Cables</b>																	
11kV Patrols & general maintenance	Planned Actions	Routine & Preventative	40 feeders	5,000	200,000		200,000	200,000	200,000	200,000	200,000	200,000	200,000	200,000	200,000	200,000	2,000,000
11kV Testing -Ultrasound scan (Poles)	Planned Actions	Routine & Preventative	1,600	50	80,000		80,000	80,000	80,000	80,000	80,000	80,000	80,000	80,000	80,000	80,000	800,000
11kV Tree Control program Wairoa	Planned Actions	Routine & Preventative	300 sites	500	150,000		150,000	150,000	150,000	150,000	150,000	150,000	150,000	150,000	150,000	150,000	1,500,000
11kV Tree control program Gisborne	Planned Actions	Routine & Preventative	900 sites	500	450,000		450,000	450,000	450,000	450,000	450,000	450,000	450,000	450,000	450,000	450,000	4,500,000
11kV Forestry Tree Control Program	Planned Actions	Routine & Preventative	10 sites	20,000	200,000		200,000	200,000	200,000	200,000	200,000	200,000	200,000	200,000	200,000	200,000	2,000,000
11kV Storm Contingency	Unplanned Actions	Fault & Emergency				100,000	100,000	100,000	100,000	100,000	100,000	100,000	100,000	100,000	100,000	100,000	1,000,000
11kV Trees forced cutting	Unplanned Actions	Fault & Emergency	125	320		100,000	100,000	100,000	100,000	100,000	100,000	100,000	100,000	100,000	100,000	100,000	1,000,000
11kV Defect / Fault repairs	Unplanned Actions	Fault & Emergency				210,000	210,000	210,000	210,000	210,000	210,000	210,000	210,000	210,000	210,000	210,000	2,100,000
11kV Fault response	Unplanned Actions	Fault & Emergency	120	1,000		120,000	120,000	120,000	120,000	120,000	120,000	120,000	120,000	120,000	120,000	120,000	1,200,000
11kVControl and Switching costs	Unplanned Actions	Routine & Preventative				20,000	20,000	20,000	20,000	20,000	20,000	20,000	20,000	20,000	20,000	20,000	200,000

11kV ABS & Redundant Equip Removal	Planned Actions	Routine & Preventative	100	500	40,000	40,000	40,000	40,000	40,000	40,000	40,000	40,000	40,000	40,000	40,000	400,000
11kV Faults Management	Planned Actions	Fault & Emergency			212,600	212,600	212,600	212,600	212,600	212,600	212,600	212,600	212,600	212,600	212,600	2,126,000
<b>11kV Lines Cables</b>					<b>1,332,600</b>	<b>550,000</b>	<b>1,882,600</b>	<b>1,882,600</b>	<b>1,882,600</b>	<b>1,882,600</b>	<b>1,882,600</b>	<b>1,882,600</b>	<b>1,882,600</b>	<b>1,882,600</b>	<b>1,882,600</b>	<b>18,826,000</b>
<b>400V Lines Cables</b>					0											
400V Line Patrols & minor maintenance	Planned Actions	Routine & Preventative	50km	200	10,000	10,000	10,000	10,000	10,000	10,000	10,000	10,000	10,000	10,000	10,000	100,000
400V Testing -Ultrasound scan (Poles)	Planned Actions	Routine & Preventative	500	30	15,000	15,000	15,000	15,000	15,000	15,000	15,000	15,000	15,000	15,000	15,000	150,000
400V Defect / Fault repairs	Unplanned Actions	Fault & Emergency			50,000	50,000	50,000	50,000	50,000	50,000	50,000	50,000	50,000	50,000	50,000	500,000
400V Fault response	Unplanned Actions	Fault & Emergency	100	250	25,000	25,000	25,000	25,000	25,000	25,000	25,000	25,000	25,000	25,000	25,000	250,000
400V General Maint Cables	Planned Actions	Routine & Preventative			10,000	10,000	10,000	10,000	10,000	10,000	10,000	10,000	10,000	10,000	10,000	100,000
400V Faults Management	Planned Actions	Fault & Emergency			19,000	19,000	19,000	19,000	19,000	19,000	19,000	19,000	19,000	19,000	19,000	190,000
<b>400v Lines Cables</b>					<b>54,000</b>	<b>75,000</b>	<b>129,000</b>	<b>129,000</b>	<b>129,000</b>	<b>129,000</b>	<b>129,000</b>	<b>129,000</b>	<b>129,000</b>	<b>129,000</b>	<b>129,000</b>	<b>1,290,000</b>
<b>Service Connections</b>																
Service Patrols/inspection & minor maint	Planned Actions	Routine & Preventative	500	10	5,000	5,000	5,000	5,000	5,000	5,000	5,000	5,000	5,000	5,000	5,000	50,000
Voltage Checks/Complaints	Unplanned Actions	Routine & Preventative	100	200	20,000	20,000	20,000	20,000	20,000	20,000	20,000	20,000	20,000	20,000	20,000	200,000
<b>Service Connections</b>					<b>5,000</b>	<b>20,000</b>	<b>25,000</b>	<b>25,000</b>	<b>25,000</b>	<b>25,000</b>	<b>25,000</b>	<b>25,000</b>	<b>25,000</b>	<b>25,000</b>	<b>25,000</b>	<b>250,000</b>
<b>Load Control</b>																
Load Control Injection plant testing & routine maint	Planned Actions	Routine & Preventative	2	4,000	8,000	8,000	8,000	8,000	8,000	8,000	8,000	8,000	8,000	8,000	8,000	80,000
Load Control Defect / Fault repairs	Unplanned Actions	Fault & Emergency			5,000	5,000	5,000	5,000	5,000	5,000	5,000	5,000	5,000	5,000	5,000	50,000
Load Control Fault response	Unplanned Actions	Fault & Emergency	36	250	5,000	5,000	5,000	5,000	5,000	5,000	5,000	5,000	5,000	5,000	5,000	50,000
Load Control Faults Management	Planned Actions	Fault & Emergency			4,000	4,000	4,000	4,000	4,000	4,000	4,000	4,000	4,000	4,000	4,000	40,000
<b>Load Control</b>					<b>12,000</b>	<b>10,000</b>	<b>22,000</b>	<b>22,000</b>	<b>22,000</b>	<b>22,000</b>	<b>22,000</b>	<b>22,000</b>	<b>22,000</b>	<b>22,000</b>	<b>22,000</b>	<b>220,000</b>
<b>Zone Substations</b>																
Zone Sub 3 Monthly Inspections & minor maint	Planned Actions	Routine & Preventative	100	250	25,000	25,000	25,000	25,000	25,000	25,000	25,000	25,000	25,000	25,000	25,000	250,000
Zone Sub Grounds Maintenance	Planned Actions	Routine & Preventative	240	125	35,000	35,000	35,000	35,000	35,000	35,000	35,000	35,000	35,000	35,000	35,000	350,000
Zone Sub Occupational Health and safety Inspect	Planned Actions	Routine & Preventative	20	250	5,000	5,000	5,000	5,000	5,000	5,000	5,000	5,000	5,000	5,000	5,000	50,000
Zone Sub Thermovision/Ultrasound Inspections	Planned Actions	Refurbishment & Renewal	20	250	5,000	5,000	5,000	5,000	5,000	5,000	5,000	5,000	5,000	5,000	5,000	50,000

Zone Sub Transformer paint	Planned Actions	Refurbishment & Renewal	1	20,000	20,000	20,000	20,000	20,000	20,000	20,000	20,000	20,000	20,000	20,000	20,000	200,000
Zone Sub Average Routine Maintenance/major maint	Planned Actions	Routine & Preventative			65,000	65,000	65,000	65,000	65,000	65,000	65,000	65,000	65,000	65,000	65,000	650,000
Zone Sub DGA furrow tests 2yr	Planned Actions	Routine & Preventative	10	1,140	11,400	11,400	11,400	11,400	11,400	11,400	11,400	11,400	11,400	11,400	11,400	114,000
Zone Sub Average tap changer overhauls 2 units p.a.	Planned Actions	Refurbishment & Renewal	1	15,000	15,000	15,000	15,000	15,000	15,000	15,000	15,000	15,000	15,000	15,000	15,000	150,000
Zone Sub Average oil processing 2 p.a.	Planned Actions	Refurbishment & Renewal	2	6,000	12,000	12,000	12,000	12,000	12,000	12,000	12,000	12,000	12,000	12,000	12,000	120,000
Zone Sub Defect / Fault repairs	Unplanned Actions	Fault & Emergency				25,000	25,000	25,000	25,000	25,000	25,000	25,000	25,000	25,000	25,000	250,000
Zone Sub Fault response	Unplanned Actions	Fault & Emergency				4,000	4,000	4,000	4,000	4,000	4,000	4,000	4,000	4,000	4,000	40,000
Zone Sub Faults Management	Planned Actions	Fault & Emergency			6,000	6,000	6,000	6,000	6,000	6,000	6,000	6,000	6,000	6,000	6,000	60,000
<b>Zone Substations</b>					<b>199,400</b>	<b>29,000</b>	<b>228,400</b>	<b>228,400</b>	<b>228,400</b>	<b>228,400</b>	<b>228,400</b>	<b>228,400</b>	<b>228,400</b>	<b>228,400</b>	<b>228,400</b>	<b>2,284,000</b>
<b>Pole Mounted Isolation Equipment</b>																
Rural CB Annual Inspections	Planned Actions	Routine & Preventative	90	150	13,500	13,500	13,500	13,500	13,500	13,500	13,500	13,500	13,500	13,500	13,500	135,000
Rural CB Average Routine Maintenance	Planned Actions	Routine & Preventative	45	400	18,000	18,000	18,000	18,000	18,000	18,000	18,000	18,000	18,000	18,000	18,000	180,000
Rural CB Defect /Fault repairs	Unplanned Actions	Fault & Emergency	5	4,000		20,000	20,000	20,000	20,000	20,000	20,000	20,000	20,000	20,000	20,000	200,000
Rural CB Faults Management	Planned Actions	Fault & Emergency			1,500	1,500	1,500	1,500	1,500	1,500	1,500	1,500	1,500	1,500	1,500	15,000
<b>Pole Mounted Isolation Equipment</b>					<b>33,000</b>	<b>20,000</b>	<b>53,000</b>	<b>53,000</b>	<b>53,000</b>	<b>53,000</b>	<b>53,000</b>	<b>53,000</b>	<b>53,000</b>	<b>53,000</b>	<b>53,000</b>	<b>530,000</b>
<b>Distribution Transformers</b>																
TX Refurbishment <100kVA	Planned Actions	Refurbishment & Renewal	10	500	5,000	5,000	5,000	5,000	5,000	5,000	5,000	5,000	5,000	5,000	5,000	50,000
TX Refurbishment >100kVA	Planned Actions	Refurbishment & Renewal	2	4,000	8,000	8,000	8,000	8,000	8,000	8,000	8,000	8,000	8,000	8,000	8,000	80,000
TX Inspection (incl minor maint & MDI's)	Planned Actions	Routine & Preventative	528	50	25,000	25,000	25,000	25,000	25,000	25,000	25,000	25,000	25,000	25,000	25,000	250,000
TX Oil Analysis/Handling /filtering /TX disposal	Planned Actions	Refurbishment & Renewal			10,000	10,000	10,000	10,000	10,000	10,000	10,000	10,000	10,000	10,000	10,000	100,000
TX Earth testing	Planned Actions	Routine & Preventative	550	45	25,000	25,000	25,000	25,000	25,000	25,000	25,000	25,000	25,000	25,000	25,000	250,000
TX Earthing system repairs	Planned Actions	Refurbishment & Renewal	100	450	45,000	45,000	45,000	45,000	45,000	45,000	45,000	45,000	45,000	45,000	45,000	450,000
TX Defect /Fault repairs	Unplanned Actions	Fault & Emergency				15,000	15,000	15,000	15,000	15,000	15,000	15,000	15,000	15,000	15,000	150,000
TX Faults Management	Planned Actions	Fault & Emergency			6,010	6,010	6,010	6,010	6,010	6,010	6,010	6,010	6,010	6,010	6,010	60,100
<b>Transformers</b>					<b>124,010</b>	<b>15,000</b>	<b>139,010</b>	<b>139,010</b>	<b>139,010</b>	<b>139,010</b>	<b>139,010</b>	<b>139,010</b>	<b>139,010</b>	<b>139,010</b>	<b>139,010</b>	<b>1,390,100</b>

11kV Switchgear Ground Mounted

11kV SWGR Inspection & Servicing/minor maint	Planned Actions	Routine & Preventative	194	50	10,000	10,000	10,000	10,000	10,000	10,000	10,000	10,000	10,000	10,000	10,000	100,000
11kV SWGR Average Switch maintenance 5yrs	Planned Actions	Refurbishment & Renewal	15	1,000	15,000	15,000	15,000	15,000	15,000	15,000	15,000	15,000	15,000	15,000	15,000	150,000
11kV SWGR Defect /Fault repairs	Unplanned Actions	Fault & Emergency			10,000	10,000	10,000	10,000	10,000	10,000	10,000	10,000	10,000	10,000	10,000	100,000
11kV SWGR General maint consumer/kiosk substns	Planned Actions	Routine & Preventative			10,000	10,000	10,000	10,000	10,000	10,000	10,000	10,000	10,000	10,000	10,000	100,000
11kV SWGR Faults Management	Planned Actions	Fault & Emergency			4,242	4,242	4,242	4,242	4,242	4,242	4,242	4,242	4,242	4,242	4,242	42,420
<b>11kV Switchgear Ground Mounted</b>					<b>39,242</b>	<b>10,000</b>	<b>49,242</b>	<b>49,242</b>	<b>49,242</b>	<b>49,242</b>	<b>49,242</b>	<b>49,242</b>	<b>49,242</b>	<b>49,242</b>	<b>49,242</b>	<b>492,420</b>
<b>LV Switchgear &amp; Pillars</b>																
400V SWGR Inspection & Servicing/minor maint	Planned Actions	Routine & Preventative	500	30	15,000	15,000	15,000	15,000	15,000	15,000	15,000	15,000	15,000	15,000	15,000	150,000
400V SWGR Defect /Fault repairs	Unplanned Actions	Fault & Emergency	100	100	10,000	10,000	10,000	10,000	10,000	10,000	10,000	10,000	10,000	10,000	10,000	100,000
Galv Box inspections & maint	Planned Actions	Routine & Preventative	150	33	5,000	5,000	5,000	5,000	5,000	5,000	5,000	5,000	5,000	5,000	5,000	50,000
400V OH Service Fuse Base & Carrier replacement	Unplanned Actions	Refurbishment & Renewal	250	200	50,000	50,000	50,000	50,000	50,000	50,000	50,000	50,000	50,000	50,000	50,000	500,000
<b>LV Switchgear</b>					<b>70,000</b>	<b>10,000</b>	<b>80,000</b>	<b>80,000</b>	<b>80,000</b>	<b>80,000</b>	<b>80,000</b>	<b>80,000</b>	<b>80,000</b>	<b>80,000</b>	<b>80,000</b>	<b>800,000</b>
<b>Communications</b>																
Comms Maintenance/Calibration	Planned Actions	Refurbishment & Renewal			35,000	35,000	35,000	35,000	35,000	35,000	35,000	35,000	35,000	35,000	35,000	350,000
Comms Track Inspection & Maintenance	Planned Actions	Routine & Preventative			4,000	4,000	4,000	4,000	4,000	4,000	4,000	4,000	4,000	4,000	4,000	40,000
Comms Hut Inspection & Maintenance	Planned Actions	Routine & Preventative			4,000	4,000	4,000	4,000	4,000	4,000	4,000	4,000	4,000	4,000	4,000	40,000
Comms Radio Licences	Planned Actions	Routine & Preventative			13,000	13,000	13,000	13,000	13,000	13,000	13,000	13,000	13,000	13,000	13,000	130,000
Comms Defect/Fault repairs	Unplanned Actions	Fault & Emergency			16,000	16,000	16,000	16,000	16,000	16,000	16,000	16,000	16,000	16,000	16,000	160,000
<b>Communications</b>					<b>56,000</b>	<b>16,000</b>	<b>72,000</b>	<b>72,000</b>	<b>72,000</b>	<b>72,000</b>	<b>72,000</b>	<b>72,000</b>	<b>72,000</b>	<b>72,000</b>	<b>72,000</b>	<b>720,000</b>
<b>SCADA</b>																
SCADA Support fees	Planned Actions	Routine & Preventative			10,000	10,000	10,000	10,000	10,000	10,000	10,000	10,000	10,000	10,000	10,000	100,000
SCADA Software Licences	Planned Actions	Routine & Preventative			5,000	5,000	5,000	5,000	5,000	5,000	5,000	5,000	5,000	5,000	5,000	50,000
SCADA maintenance allowance	Planned Actions	Refurbishment & Renewal			10,000	10,000	10,000	10,000	10,000	10,000	10,000	10,000	10,000	10,000	10,000	100,000
SCADA Configuration and file alterations	Planned Actions	Routine & Preventative			6,000	6,000	6,000	6,000	6,000	6,000	6,000	6,000	6,000	6,000	6,000	60,000
SCADA Defect/Fault repairs	Unplanned Actions	Fault & Emergency			10,000	10,000	10,000	10,000	10,000	10,000	10,000	10,000	10,000	10,000	10,000	100,000
<b>SCADA</b>					<b>31,000</b>	<b>10,000</b>	<b>41,000</b>	<b>41,000</b>	<b>41,000</b>	<b>41,000</b>	<b>41,000</b>	<b>41,000</b>	<b>41,000</b>	<b>41,000</b>	<b>41,000</b>	<b>410,000</b>

**FAULTS MANAGEMENT**

Planned Actions	Fault & Emergency	273,352		273,352	273,352	273,352	273,352	273,352	273,352	273,352	273,352	273,352	273,352	273,352	2,733,520
	<b>Faults MGT</b>	273,352	0	273,352	273,352	273,352	273,352	273,352	273,352	273,352	273,352	273,352	273,352	273,352	2,733,520
	<b>Total Network Maintenance Expenditure Projections</b>	2,080,252	803,500	2,883,752	2,883,752	2,883,752	2,883,752	2,883,752	2,883,752	2,883,752	2,883,752	2,883,752	2,883,752	2,883,752	28,837,520

**Summary by Category**

Planned Actions	Routine & Preventative		1,526,900	1,526,900	1,526,900	1,526,900	1,526,900	1,526,900	1,526,900	1,526,900	1,526,900	1,526,900	1,526,900	1,526,900	15,269,000
Unplanned Actions	Routine & Preventative		40,000	40,000	40,000	40,000	40,000	40,000	40,000	40,000	40,000	40,000	40,000	40,000	400,000
	sub total		1,566,900	1,566,900	1,566,900	1,566,900	1,566,900	1,566,900	1,566,900	1,566,900	1,566,900	1,566,900	1,566,900	1,566,900	15,669,000
Planned Actions	Fault & Emergency		273,352	273,352	273,352	273,352	273,352	273,352	273,352	273,352	273,352	273,352	273,352	273,352	2,733,520
Unplanned Actions	Fault & Emergency		763,500	763,500	763,500	763,500	763,500	763,500	763,500	763,500	763,500	763,500	763,500	763,500	7,635,000
	sub total		1,036,852	1,036,852	1,036,852	1,036,852	1,036,852	1,036,852	1,036,852	1,036,852	1,036,852	1,036,852	1,036,852	1,036,852	10,368,520
Planned Actions	Refurbishment & Renewal		230,000	230,000	230,000	230,000	230,000	230,000	230,000	230,000	230,000	230,000	230,000	230,000	2,300,000
Unplanned Actions	Refurbishment & Renewal		50,000	50,000	50,000	50,000	50,000	50,000	50,000	50,000	50,000	50,000	50,000	500,000	
	sub total		280,000	280,000	280,000	280,000	280,000	280,000	280,000	280,000	280,000	280,000	280,000	280,000	2,800,000
<b>Total</b>	<b>Maintenance</b>		2,883,752	2,883,752	2,883,752	2,883,752	2,883,752	2,883,752	2,883,752	2,883,752	2,883,752	2,883,752	2,883,752	2,883,752	28,837,520

**Summary by Planned, Unplanned**

Planned Actions	Total		2,030,252	2,030,252	2,030,252	2,030,252	2,030,252	2,030,252	2,030,252	2,030,252	2,030,252	2,030,252	2,030,252	2,030,252	20,302,520
Unplanned Actions	Total		853,500	853,500	853,500	853,500	853,500	853,500	853,500	853,500	853,500	853,500	853,500	853,500	8,535,000
<b>Total</b>	<b>Maintenance</b>		2,883,752	2,883,752	2,883,752	2,883,752	2,883,752	2,883,752	2,883,752	2,883,752	2,883,752	2,883,752	2,883,752	2,883,752	28,837,520

**Summary by Asset Group**  
Sub-trans Lines & cables

		0													
			2012/13	2013/14	2014/15	2015/16	2016/17	2017/18	2018/19	2019/20	2020/21	2021/22	Total		
			162,500	162,500	162,500	162,500	162,500	162,500	162,500	162,500	162,500	162,500	1,625,000		



11kV Lines & Cables	1,882,600	1,882,600	1,882,600	1,882,600	1,882,600	1,882,600	1,882,600	1,882,600	1,882,600	1,882,600	1,882,600	<b>18,826,000</b>
400V Lines & Cables	129,000	129,000	129,000	129,000	129,000	129,000	129,000	129,000	129,000	129,000	129,000	<b>1,290,000</b>
Service Connections	25,000	25,000	25,000	25,000	25,000	25,000	25,000	25,000	25,000	25,000	25,000	<b>250,000</b>
Load control	22,000	22,000	22,000	22,000	22,000	22,000	22,000	22,000	22,000	22,000	22,000	<b>220,000</b>
Zone Substations	228,400	228,400	228,400	228,400	228,400	228,400	228,400	228,400	228,400	228,400	228,400	<b>2,284,000</b>
Pole Mounted Isolation Equipment	53,000	53,000	53,000	53,000	53,000	53,000	53,000	53,000	53,000	53,000	53,000	<b>530,000</b>
Distribution Transformers	139,010	139,010	139,010	139,010	139,010	139,010	139,010	139,010	139,010	139,010	139,010	<b>1,390,100</b>
11kV Switchgear Ground Mounted	49,242	49,242	49,242	49,242	49,242	49,242	49,242	49,242	49,242	49,242	49,242	<b>492,420</b>
LV Switchgear	80,000	80,000	80,000	80,000	80,000	80,000	80,000	80,000	80,000	80,000	80,000	<b>800,000</b>
Communications	72,000	72,000	72,000	72,000	72,000	72,000	72,000	72,000	72,000	72,000	72,000	<b>720,000</b>
SCADA	41,000	41,000	41,000	41,000	41,000	41,000	41,000	41,000	41,000	41,000	41,000	<b>410,000</b>
<b>TOTAL NETWORK</b>	<b>2,883,752</b>	<b>2,883,752</b>	<b>2,883,752</b>	<b>2,883,752</b>	<b>2,883,752</b>	<b>2,883,752</b>	<b>2,883,752</b>	<b>2,883,752</b>	<b>2,883,752</b>	<b>2,883,752</b>	<b>2,883,752</b>	<b>28,837,520</b>

## **7.4 How is the asset value changing**

Ideally ENL’s asset value should remain fairly constant given the average position in terms of security and performance and general satisfaction, across the consumer base with the security/performance verses price trade off currently provided. Any decline of service potential associated with the aging asset should be off-set by an equal restoring of service potential. Factors that will influence the asset value are shown in Table 7.4(a) below...

**Table 7.4(a) – Factors influencing asset value**

<b>Factors that increase asset value</b>	<b>Factors that decrease asset value</b>
Addition of new assets to the network as a result of improvements to Security and Performance levels or new asset in response to growth.	Removal of assets from the network generally associated with moving industrial and commercial load centers.
Renewal of existing assets. Note the definition of renewal as being restoration of original functionality – no increase in service potential beyond original functionality.	On-going depreciation of assets.
Increase of standard component values implicit in the ODV methodology.	Reduction of standard component values implicit in the ODV methodology.

At a practical level ENL’s asset valuation will vary even in the absence of component revaluations. This is principally because the accounting treatment of depreciation models the decline in service potential as a straight line (when in most cases it is more closely reflected by an inverted bath-tub curve) whilst the restoration of service potential is very “lumpy”. However the aggregation of many depreciating assets and many restoration projects tends to smooth short-term variations in asset value.

The asset value ratio across the urban and rural assets is changing. The urban asset value is increasing as the rural asset value is decreasing. This shift is in line with the greater levels of security and higher performance levels provided in the urban centers. The shift is also influenced by economic justification. With controls on the differential between more economic urban and less uneconomic rural tariffs, the matching of expenditure, affecting asset condition and age, to income, ultimately results in a corresponding shift of asset value.

## **7.5 Depreciation and Renewal of the assets**

ENL has identified a gap between required renewal rates to maintain asset age and current targeted rates, primarily limited by available funding.

The nature of the existing asset is such that it will physically deteriorate over its life until it reaches a stage where renewal is required to maintain service. In addition the life expectancies of the components making up the asset are varied which affects the accuracy of renewal forecasts. The renewal costs for these asset components need to be provided for over their respective lives.

Depreciation provides the mechanism to fund this renewal.

The ability for renewal to be funded by depreciation is affected by-

- The correct value being assigned to the assets
- The correct age expectancy being assigned to the assets
- Stability of the costs for the new equivalent asset over time.
- Selection of the correct asset components to be removed.

The asset value for ENL has been based on the ODV methodology.

This methodology values the existing asset assuming no asset exists initially, 'Green fields approach' and lowest standard cost of the minimum required asset over a 10 year planning cycle.

This method of valuation differs from the actual renewal situation in the following areas...

- Renewal costs include costs to remove the existing asset and maintain service while the new asset is installed.
- The planning period adopted for new assets is generally greater than 10 years to align more closely with asset life hence avoiding frequent upgrade on an in-service asset that is difficult to access.
- At the component level it is often appropriate to change assets not at end of life in conjunction with the asset targeted for renewal.

Any short fall between depreciation funding and renewal cost must be provided from some other source.

The justifiable growth component of renewal expenditure can be sourced from growth funding made available from growth revenue or borrowing.

Higher charges or reduction in the Return on Asset provided to the shareholder can also provide the additional funding.

Finally retiring of the asset at the time of failure, with the resulting reduction or total loss of service is a consideration.

Given set requirements for shareholder expectations, set requirements from regulators for revenue, defined limits and justifications on borrowing levels and the need to allocate funding to growth and performance improvement, ENL has identified a gap developing between forecast required renewal rates and the target rates that can be financially achieved. This will be particularly

significant as ENL approaches the “bow wave” of asset renewals that can be seen in the age profiles for asset components.

The renewal section of this plan identifies the forecast and targeted renewal rates ENL has adopted. For 11kV conductor, a gap as described above is currently developing. For the general case while the set limits remain in place the average age of the asset is increasing and the performance may decline. The observable effects of the declining performance are being offset in the medium term by technology innovations that can be implemented at lower cost than the renewal alternative. Also ENL has identified medium term options to minimise this issue for remote or uneconomic lines which focus on improving systems to target the components requiring renewal more precisely and allowing failures while ensuring backup systems are adequate to maintain performance.

ENL’s conclusion is that at some point it must be given an opportunity to increase prices which will enable a balance to be achieved between the level of network investment required and return on asset requirements. Otherwise there is increased risk of performance failure in terms of regulation, customer expectation and sustainability of the business.

## 8. Performance & improvement

### 8.1 Performance against financial plans

ENL's financial year operates from 1 April to 31 March. The results for performance against budget for the previous 12 month asset management period 2009/10 for both capital and maintenance expenditure are shown in the tables below.

(Note; Summary information as per Disclosure Requirement 7(5) is included on form AM1 in Appendix A2)

<b>Capital Expenditure Comparison Summary by Asset Group</b>	<b>2010/11 Budget \$</b>	<b>2010/11 Actual \$</b>	<b>2010/11 Difference \$</b>
50 kV Lines	\$ 890,000	\$ 110,262	\$ 779,738
11kV Lines and Cables	\$ 2,550,000	\$ 2,737,343	-\$ 187,343
LT Lines and Cables	\$ 550,000	\$ 432,026	\$ 117,974
Service Connections	\$ 95,000	\$ 25,601	\$ 69,399
Load Control	\$ 45,000	\$ 11,150	\$ 33,850
Zone Substations	\$ 20,000	\$ 49,294	-\$ 29,294
50kV CB's	\$ 100,000	\$ 190,615	-\$ 90,615
11kV CB's	\$ 25,000	\$ 25,716	-\$ 716
Distribution Transformers	\$ 573,000	\$ 600,311	-\$ 27,311
Pole Mounted Isolation Equipment	\$ 120,000	\$ 164,013	-\$ 44,013
11kV Ground Mounted Switchgear	\$ 90,000	\$ 144,873	-\$ 54,873
LV Switchgear	\$ 80,000	\$ 37,679	\$ 42,321
Control and Protection	\$ 30,000	\$ 20,693	\$ 9,307
Communications	\$ 80,000	\$ 54,214	\$ 25,786
SCADA	\$ 32,000	\$ 12,898	\$ 19,102
Other	\$ 45,000	\$ 47,582	-\$ 2,582
<b>TOTAL</b>	<b>\$ 5,325,000</b>	<b>\$ 4,664,271</b>	<b>\$ 660,729</b>

<b>Capital Expenditure Comparison Summary by Category</b>	<b>2010/11 Budget \$</b>	<b>2010/11 Actual \$</b>	<b>2010/11 Difference \$</b>
Performance/Development	\$ 150,000	\$ 124,270	\$ 25,730
Growth/Security	\$ 1,028,000	\$ 645,459	\$ 382,541
Condition/Compliance	\$ 4,007,000	\$ 3,816,303	\$ 190,697
Generation	\$ -	\$ -	\$ -
Customer Connection	\$ 90,000	\$ 78,238	\$ 11,762
Asset Relocations	\$ 50,000	\$ -	\$ 50,000
<b>TOTAL</b>	<b>\$ 5,325,000</b>	<b>\$ 4,664,271</b>	<b>\$ 660,729</b>

<b>Capital Expenditure Comparison</b>	<b>2010/11</b>	<b>2010/11</b>	<b>2010/11</b>
---------------------------------------	----------------	----------------	----------------

Summary by Type	Budget \$	Actual \$	Difference \$
Planned	\$ 4,277,000	\$ 3,718,310	\$ 558,690
Unplanned	\$ 1,048,000	\$ 945,961	\$ 102,039
<b>TOTAL</b>	<b>\$ 5,325,000</b>	<b>\$ 4,664,270</b>	<b>\$ 660,730</b>

Maintenance Expenditure Comparison Summary by Asset Group	2010/11 Budget \$	2010/11 Actual \$	2010/11 Difference \$
50 kV Lines	\$ 162,500	\$ 97,298	\$ 65,202
11kV Lines and Cables	\$ 1,752,600	\$ 1,461,756	\$ 290,844
LT Lines and Cables	\$ 129,000	\$ 110,705	\$ 18,295
Service Connections	\$ 25,000	\$ 49,769	-\$ 24,769
Load Control	\$ 22,000	\$ 19,231	\$ 2,769
Zone Substations	\$ 228,440	\$ 186,455	\$ 41,985
CB's	\$ 53,000	\$ 30,072	\$ 22,928
Distribution Transformers	\$ 139,010	\$ 38,988	\$ 100,022
11kV Ground Mounted Switchgear	\$ 49,242	\$ 25,873	\$ 23,369
LV Switchgear	\$ 80,000	\$ 10,094	\$ 69,906
Communications	\$ 72,000	\$ 69,385	\$ 2,615
SCADA	\$ 41,000	\$ 231	\$ 40,769
<b>TOTAL</b>	<b>\$ 2,753,792</b>	<b>\$ 2,099,856</b>	<b>\$ 653,936</b>

Maintenance Expenditure Comparison Summary by Asset Group	2010/11 Budget \$	2010/11 Actual \$	2010/11 Difference \$
Routine and Preventative	\$ 1,486,940	\$ 1,019,000	\$ 467,940
Refurbishment and Renewal	\$ 280,000	\$ 143,567	\$ 136,433
Fault and Emergency	\$ 986,852	\$ 937,289	\$ 49,563
<b>TOTAL</b>	<b>\$ 2,753,792</b>	<b>\$ 2,099,856</b>	<b>\$ 653,936</b>

Maintenance Expenditure Comparison Summary by Category	2010/11 Budget \$	2010/11 Actual \$	2010/11 Difference \$
Unplanned	\$ 753,500	\$ 686,525	\$ 66,975
Planned	\$ 2,000,292	\$ 1,413,331	\$ 586,961
<b>TOTAL</b>	<b>\$ 2,753,792</b>	<b>\$ 2,099,856</b>	<b>\$ 653,936</b>

A total variation of \$1.313m under spend exists between the 2010/11 combined capital (\$660k) and maintenance (\$653k) expenditure budgets and the actual expenditure achieved.

### Capital Expenditure

A total variance of \$660k occurred between the 2010/11 budget and actual capital expenditure. Reasons for this variance are provided below in relation to the categories of capital expenditure.

The \$190k variance in Condition and Compliance, (renewal) expenditure is the resultant of the following;

- The short fall of available contractor resources. Both locally and nationally based contractors are depleted of skilled resources due to the legacy over past years of scaled back training of electrical workers and the financial attraction of overseas employment. Poor responses to tenders issued for renewal projects resulted in scheduled 11kV and 400V pole and conductor replacements being deferred.
- Unrealistic cost. Due to a combination of a number of external factors tender for work have indicated costs in the order of 4 times ODV standard costs reflecting supply and demand leverage due to resource shortages rather than true costs to undertake the work.
- Planning influence of regulated service levels. To ensure compliance with regulated outage measures, large shutdowns typically associated with conductor replacement projects have not proceeded as planned.

ENL continues to encourage local contractors to employ more staff however in common with other many Gisborne based industries they have difficulty in attracting interest from suitably qualified and experienced applicants. The Eastland Group has established Eastech as a contracting business to support ENL and maintain minimum response resource levels in the region. Whilst these actions do not completely address the resource shortage, a mechanism is now in place to develop more capability in the medium term by establishing in-house training to national standards for Line mechanics. ENL also continues to canvas national electrical contracting companies about carrying out work on a project basis in the Gisborne area.

The \$382k variance in Growth and Security expenditure is the resultant of the following;

- Mahia 33kV project is delayed pending consents and the negotiation of easements
- Regional development is low hence forecast growth has not been met.

The \$25k variation in Development and Performance expenditure is the resultant of the following;

- Pillar Replacement delayed due to engineering and project management shortages.

### **Maintenance Expenditure**

A total variance of \$654k occurred between the 2010/11 budget and actual maintenance expenditure. Reasons for this variance are as follows;

- Unplanned maintenance, \$66k under spend reflected a favourable year in terms of environmental and physical operational conditions which caused damage lower than the typical expectation.
- Planned maintenance, a \$586k variation against a budget of \$2.00m. The underspend occurred primarily due to the lack of skilled contractor resources to carry out some of the higher end activities such as load control plant injection testing and 50kV, 11kV, zone substation thermo vision/ultrasound testing and communications work. During the year over 50% of the project management resource was allocated to preparation of documentation for audit of the public safety management systems which limited the ability to organise the work.

### **Historical performance**

The overall past performance to budget is indicated in the following chart. Following the 2001/02 catch up capital expenditure shows a trend declining to over time 2007/08. From 2007/08 the trend indicates a steady state pattern. Shortfalls of actual verses budgeted expenditure reflects the gradual increase in asset age forecast over time and potentially indicates the need for future catch up work when the factors governing expenditure change.



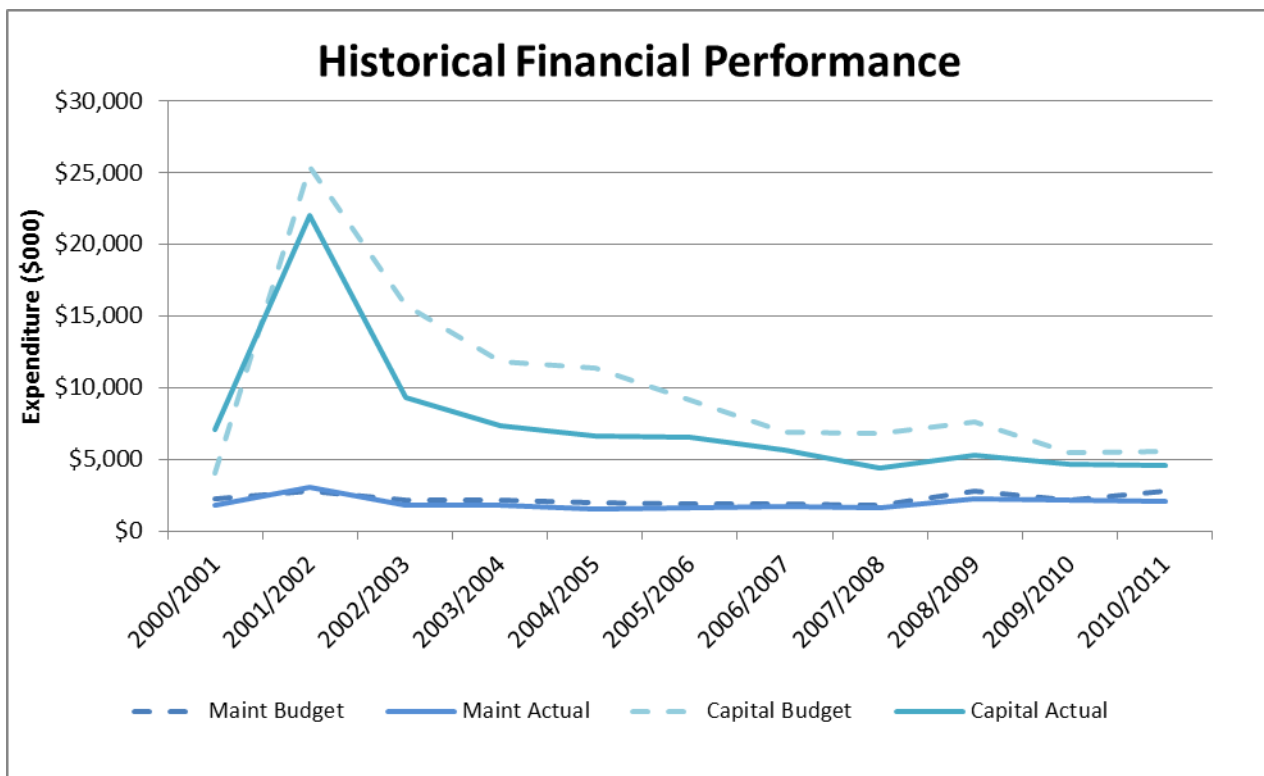

## 8.2 Meeting performance targets

### 8.2.1 Primary Service Levels

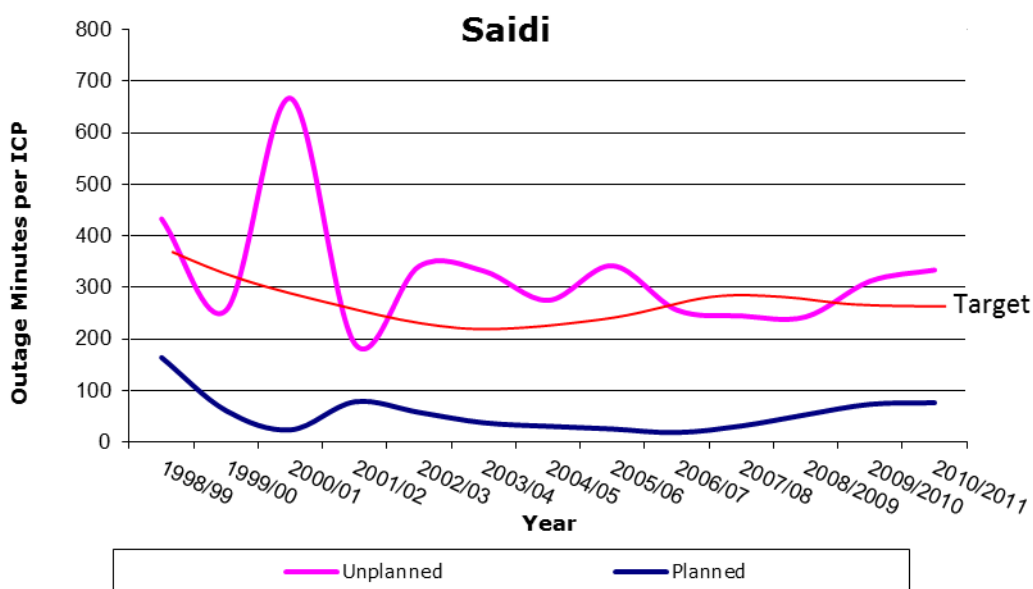

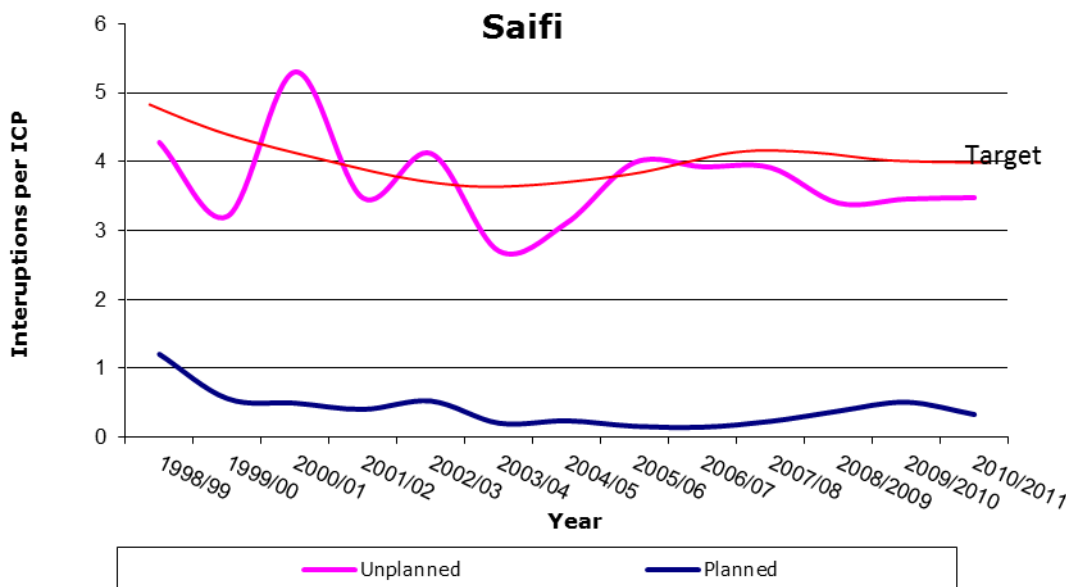

The primary indicator of reliability performance is the SAIDI index. The regulatory Limits applicable to the current annual SAIDI and SAIFI are 302.3 and 4.25 respectively. These limits are determined based on past performance basis. Besides inherent system security, a wide range of factors impact on observed reliability.

Protection and rural automation is an area where technology delivers large reductions in the impact of outages. ENL has progressively improved the network with this technology between 2000 and 2006.

Optimisation of isolation points between 2000 and 2001 has also contributed to improved performance.

Installation of remote diesel generators between 2002 and 2003 has reduced the impact of planned outages. On average over the past 6 years use of generators has avoided 254 SAIDI minutes p.a., or 50% of the current level, p.a. over the period. The extent of this reduction cannot be seen in the statistics as pole replacement on spur 50kV lines, previously deferred, was undertaken between 2003 and 2008 without any impact on outage statistics.

Use of Live line technologies has avoided an average of 10 SAIDI minutes p.a. between 2001 and 2008. As a result of skill shortages in 2007 and 2008 and an increase in line renewal work over rugged terrain, the use of Live Line technologies is currently suspended.

While the targeted SAIDI is below the regulated limit a shift to renewal projects on lines not suited to generator support will increase planned SAIDI figures. It is likely that the regulatory limits will be exceeded in future due to this increase in necessary maintenance and renewals works on the rural or spur lines.

Significant storm events and environmental factors such as slips after long periods of, generally considered as normal, rainfall have the most significant impact on ENL's ability to achieve its targets. This is evident in the 2000/2001 result where a single 24 hour event

contributed to 415.64 SAIDI minutes i.e. 64% of the year's unplanned outages.

Other significant events are as follows...

- 2003/2004 130.36 Minutes, July storm
- 2005/2006 83.83 Minutes, October storm
- 2006/2007 99.07 Minutes, June storm
- 2007/2008 53.00 Minutes, Christmas Earthquake

Subtraction of these events shows ENL can obtain the target levels through activities it can control.

### 8.2.2 Outage Cause analysis

Cause analysis as a percentage of the total customers affected multiplied by-minutes of interruption time during the last year provides the following spread:

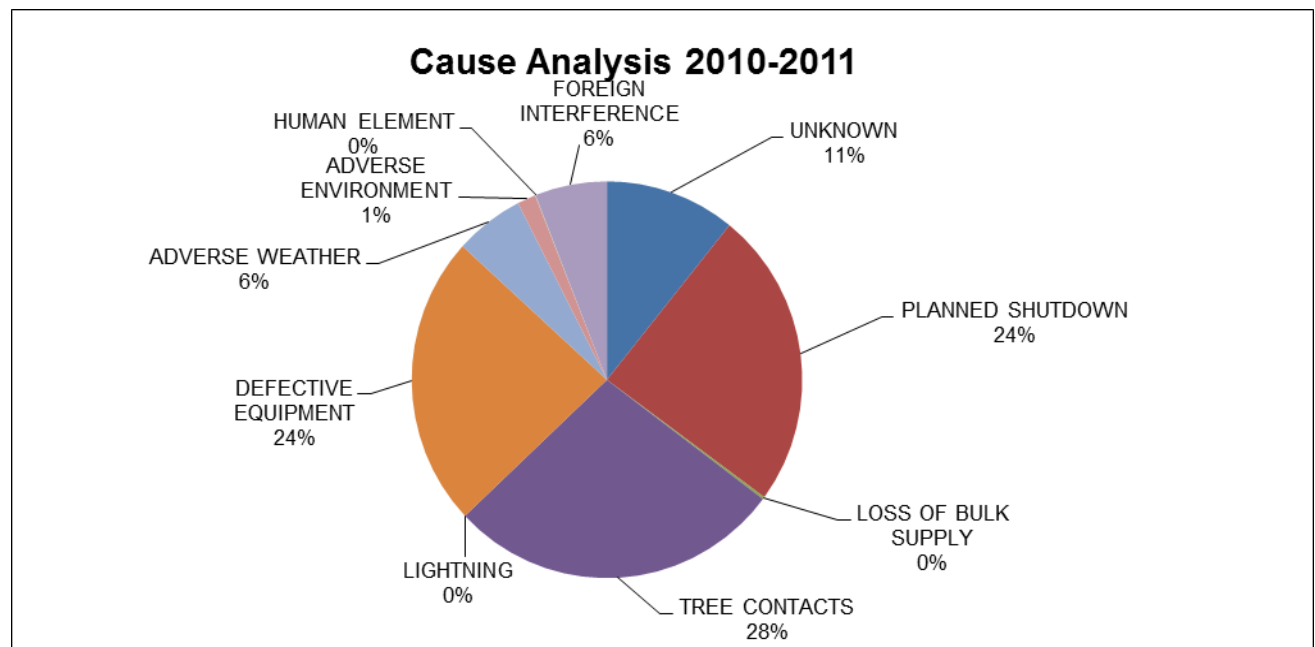

Planned shutdowns have changed from 7% of outage duration during 2006/07 to 24% from 2009 onward. This figure is consistent with the capital and maintenance program activities planned.

Actions have been taken to reduce the level of unknown causes 11% previously 20%, over past years, since it frustrates an effective management response. Initiatives have included improved field fault reporting, automation projects, and follow-up patrols to short lived faults.

The adverse weather component is in effect indicative of poor or ageing asset condition, since power lines are designed for outdoor conditions for the duration of their design life with the conductor

becoming a predominant issue. Under design is not normally an issue with the exception of extreme wind snow loading events every 2 or 3 years. Designing to these conditions is not considered economic and ENL chooses to manage this risk.

Foreign interference while previously increasing, initially at 9% the figure climbed to 18% in 2007/08 and has now reduced to 6%. This figure is driven by vehicles/pole collisions. Rural automation technology has minimised the impact of these faults however the number of incidents is increasing. The road authorities introduced new standards for location of structures alongside roads in 2006. All replacement structures need to conform to set minimum distances from the road edge or be protected by barriers. The costs to upgrade the existing works as part of the renewal will ultimately be borne by ENL's customers rather than the road users, under the new rules. Bird strikes also contribute to this category. A long-term objective is to clean down structure design and increase separations to reduce bird strikes and animal interference.

Defective equipment is currently 24%. Faults in this category tend to have long repair times/high customer minutes. Causes are generally condition related resulting from assets remaining in service after their optimum replacement date hence the result is reflecting the decision to allow the asset in rural areas to increase in age. There is also an increasing trend for newer equipment to fail prior to expectations largely due to reduced quality and workmanship at manufacture. Standardisation on proven product, rigid specification and quality control procedures has been introduced to address this issue.

Defective equipment events (particularly pole failures) have reduced significantly since completion of the major Compliance Management Project undertaken in 2001–2002. This captured many age-related condition issues and brought performance more into line with normal expectations. Improvement of the ABS asset condition is being managed via long term replacement programs.

Conductor failure is expected to predominate. This is discussed in lifecycle replacement plans.

Tree contacts are currently 28% and increase on previous years. The result is influenced by the type and nature of large storms. The figure includes minor tree contacts flying tree debris and falling trees typically outside of the cut zone. The tree regulations and rules governing access to private property have influenced the poor result. As the rules have been implemented the notification processes involved have provided a window in which the trees have encroached safe cut zones. Having grown within the safe cut zone, outages, which are also constrained to ensure regulatory targets are not

breached, are now required to remove the trees. The approved resource trained to cut the trees safely is also limited. Over time ENL's expects to reduce the tree problems as much as practicable, within the requirements of the regulations, which are generally confined to inaccessible rural and remote areas, on privately owned sections of line or forestry blocks. Although the tree regulations provide for cost recovery from tree owners ENL's experience is that faults are likely to occur well before owners can act once the trees have reached the notice zone. Expenditure forecasts for tree control have been increased to compensate.

The Human element figure of 0% reflects the quality of safety standards and work practices in place to minimise contractor error.

### **8.2.3 Subtransmission Performance**

The performance of Subtransmission feeders is summarised in the following charts showing an average annual performance over the past 6 years. The Massey Makaraka 50kV line appears as the worst performing section of line following a few rare events of significant impact. The development work on the 50kV rings described in previous plans has been completed following these events hence future performance of this line is expected to compare with that of the Massey Carnarvon 50kV line. The Tolaga Bay Goodwin 50kV line has also had significant pole renewal between 2007 and 2008; hence the line is expected to show improved performance in future.

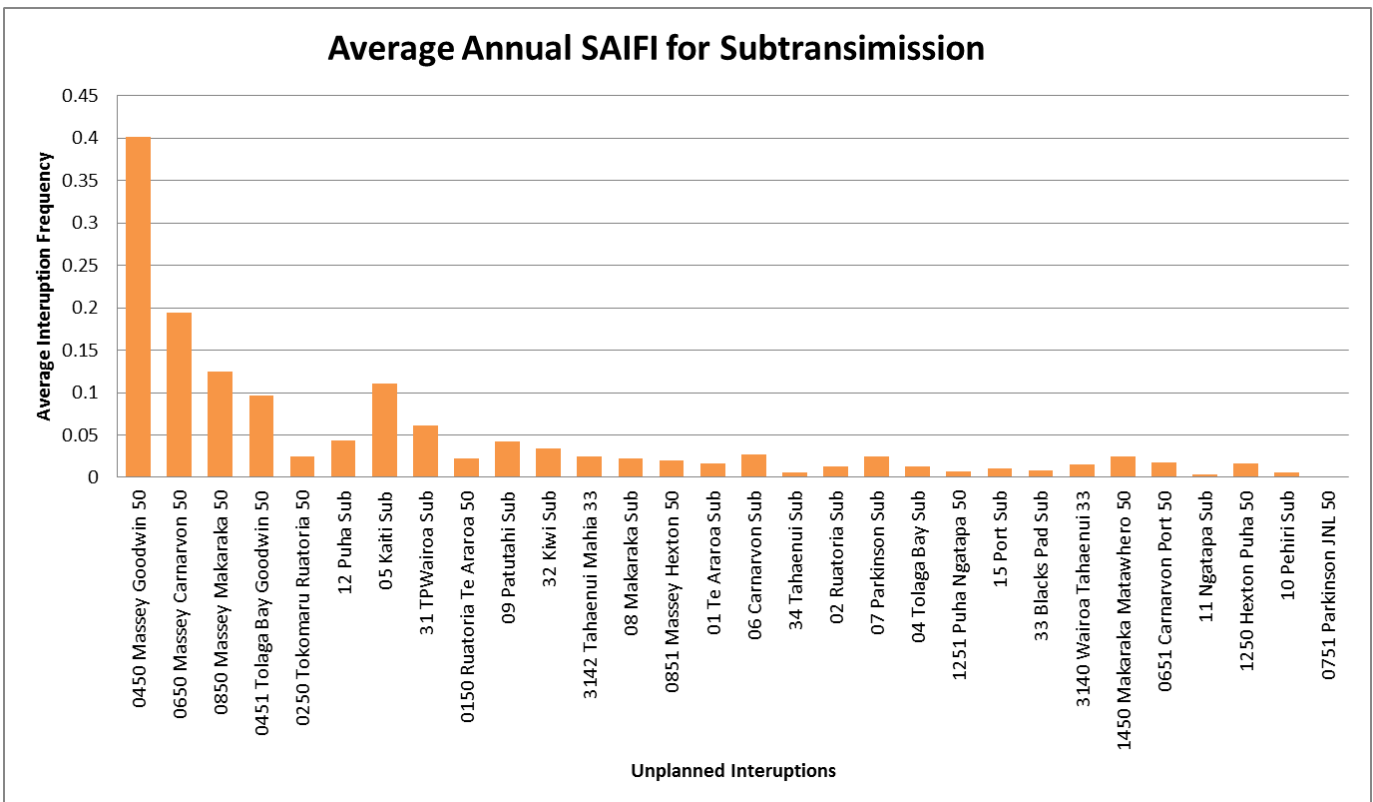
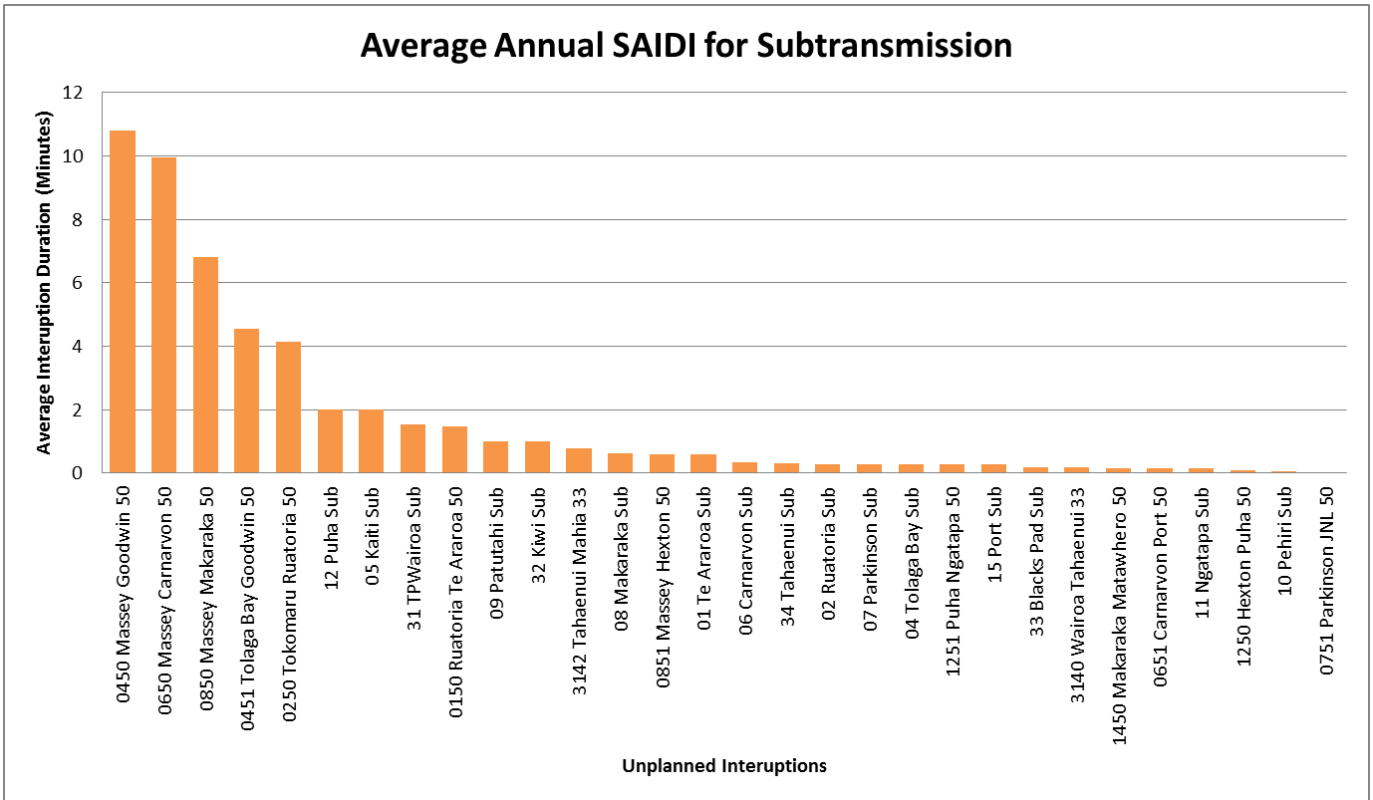

**8.2.4 Distribution Performance**

The performance of distribution feeders is summarised in the following charts showing an average annual performance over the past 6 years.

Based on location, terrain and feeder length comparisons the results indicate a performance in line with expectations. Improvements associated with Matawai and The Wairoa feeders (3201, 3203 and Mahia) have been addressed by projects identified in the development section of this plan.

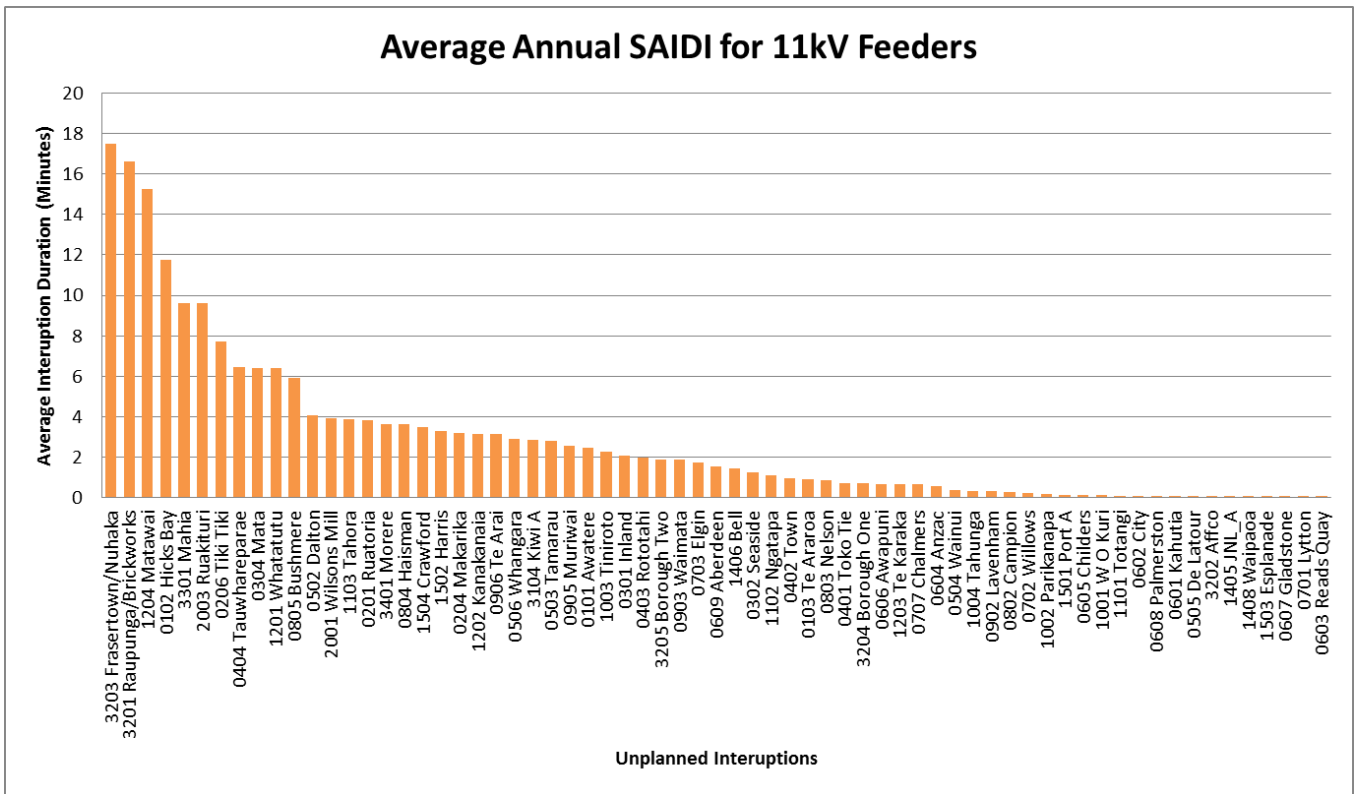

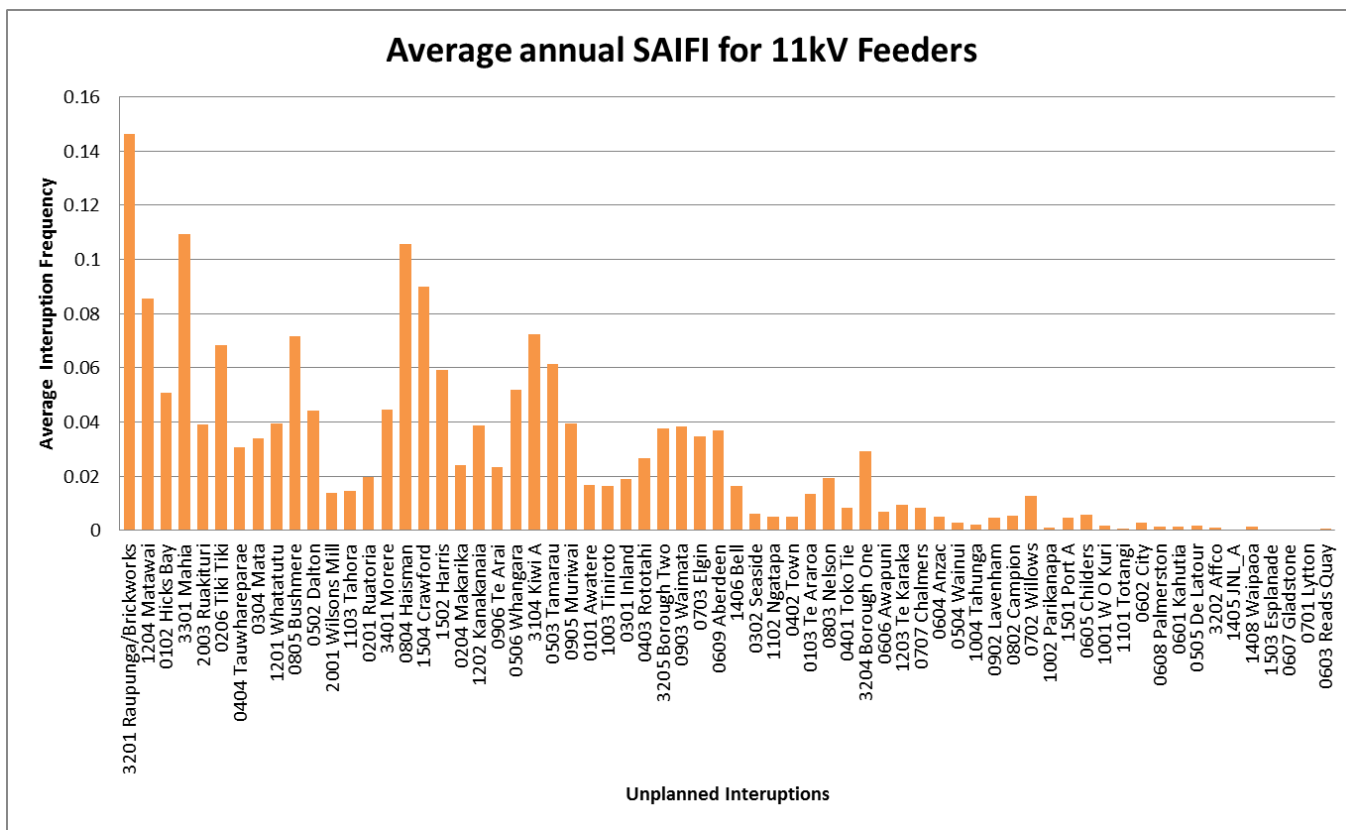

### 8.3 Meeting Delivery Efficiency targets

Cost performance measures that are disclosed each year include:

- Direct cost / km
- Indirect cost / connection

The historical trends for ENL’s efficiency targets compared with the industry position are as follows...



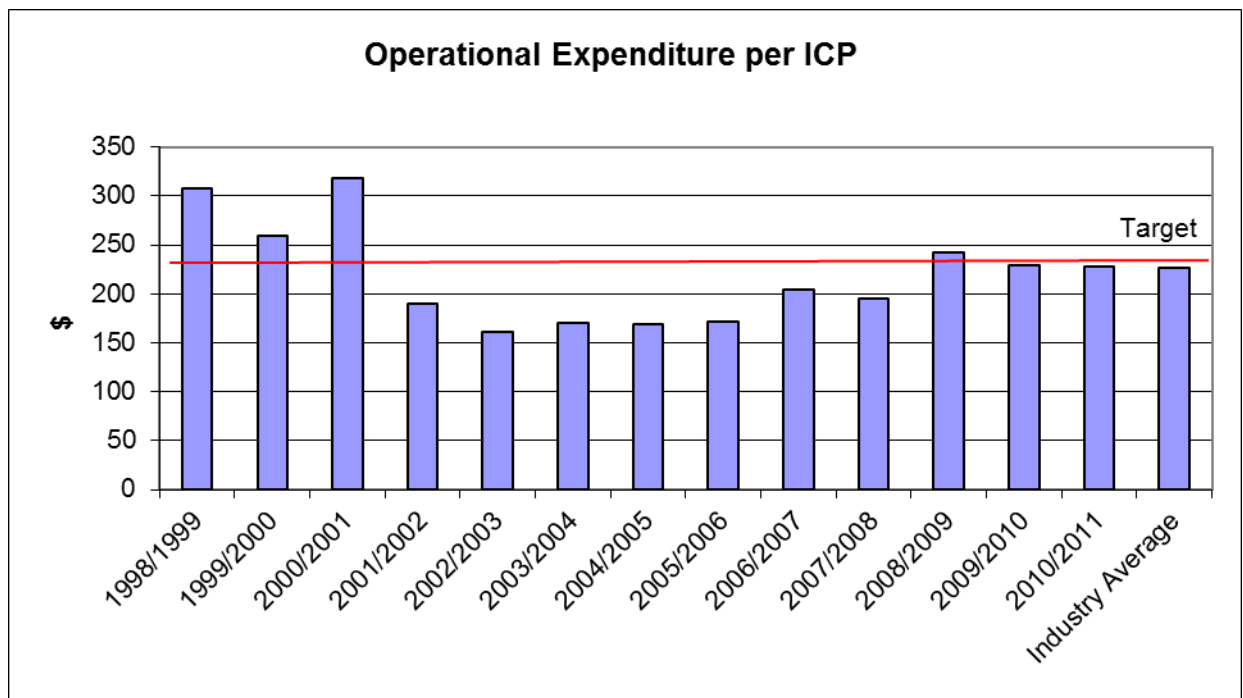
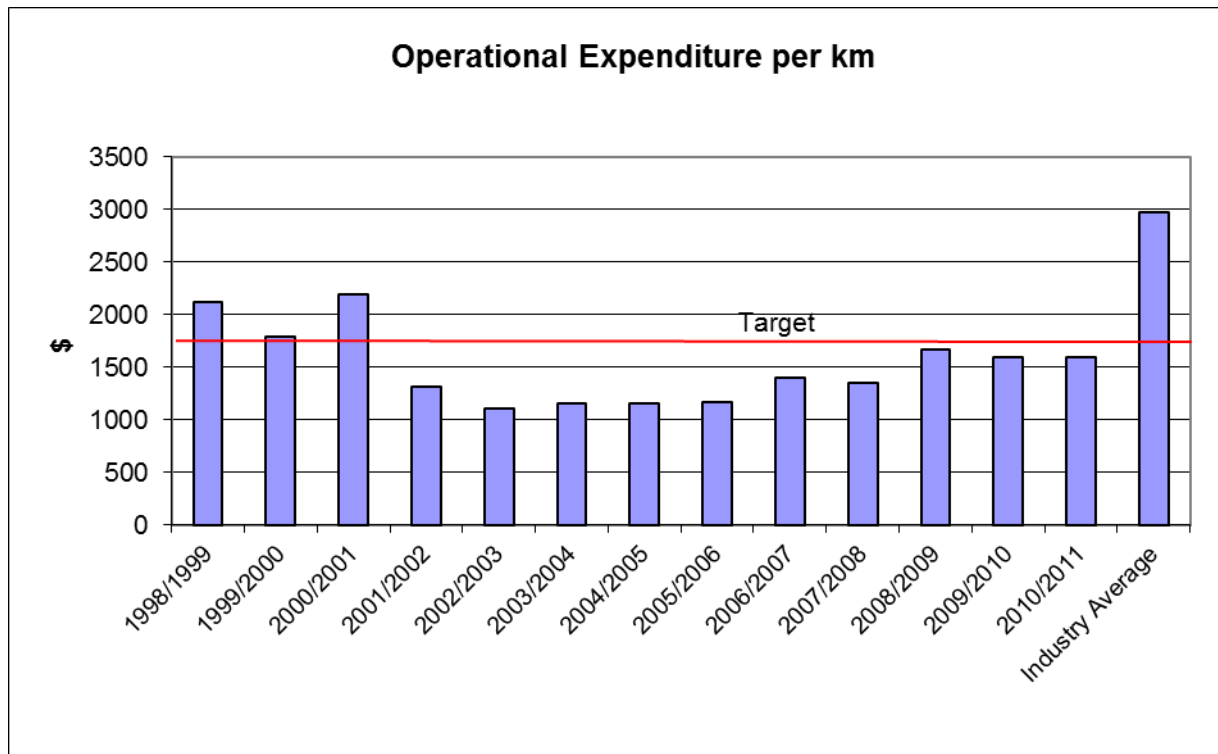

Changes to targets occur as a result of the analysis of the business results and changes to the business strategic plan. The increases to the indirect cost target directly correspond to strategic changes in the structure of Eastland Group support services, increasing insurance costs, increasing rates and steadily increasing regulatory compliance costs. The operational expenditure per km is well below the industry average. This suggests the level of maintenance on rural lines is

somewhat lower than average. This links to the poorer than average performance levels for the rural lines for a given cost to the customer.

## **8.4 Asset Management Review**

ENL maintains asset management systems, processes and plans on an on-going basis. Targets, Budgets, Project programs, Issues and Forecasts presented in this AMP are continually updated as new or changed Strategies, Requirements, Issues, Developments, Information and Data is obtained.

Executive and Board level assessments of the ENL Asset Management Plans indicate that the nature and level of content in the plan required under regulation exceeds the levels necessary for ENL to efficiently carry out its asset management activities.

Review and assessments of the ENL asset management plans undertaken by the engineering management team indicate that while the description and layout of information may have room for improvement, the additional resource and expenditure to achieve a fully compliant plan is not justified as there would be an insignificant impact on the physical outcomes relating to the assets.

An independent review of this asset management plan is undertaken annually by consultants appointed by the Commerce Commission. Results of the review are published by the Commerce Commission. ENL carries out an assessment of the specific non compliances and incorporates any additional content or clarifications to subsequent versions of this plan. The 2011 Asset Management Plan reviews resulted in ENL attaining an average rating of 2.74 or more, which is considered to be mostly compliant with only minor areas of partial compliance.

A Telarc audit is undertaken to audit the aspects of Asset Management associated with Public Safety Management as required by the Electricity Safety Regulations. Non- compliances and corrective actions are incorporated into improvement initiatives and action plans.

## **8.5 Areas for Improvement**

In general historical expenditure in any given period has been below the financial targets set. While deferral of costs is valid when forecast triggers do not occur at the time initially predicted, there is an on-going need to minimise the reaction time frame once the expenditure requirement has occurred. The ability to predict the timing for necessary renewal and growth expenditure can also be improved.

The customer oriented service levels currently established, relying on representation from government, significant customers and key groups. Refer section 3.1. ENL has identified a need to develop a strategy to broaden the contact group and identify innovative methods to source statistically truer representation of the end users requirements.

The survey results to date have identified customers have issues but they are not asking for correction of these issues if the measures are linked to increased costs. Identification of methods to eliminate the issues without increasing costs disproportionately is necessary in order to improve the satisfaction of end users.

Asset Condition has been identified in the section 5.4 of this plan as having a gap in terms of currently targeted renewal quantities verses forecast expectations of asset failure for some asset categories. For 11kV lines this has also been considered in the development section of this plan. The installation profile of the overall asset and historical practices has provided a 'bow wave' effect where at some point the steady state approach for asset renewal adopted by ENL to manage expenditure in line with predictable revenues may not keep up with the asset deterioration. To ensure the correct assets are targeted for renewal at the right time the process for condition assessments and selection need to be optimised.

The uncertainty associated with correct and informed decision making for network development, linked to changing regulatory control, safety and environmental protection requirements requires a high level of understanding of industry direction going forward. Past systems used in a stable environment with a lower rate of change are no longer adequate and increased involvement in the industry policy making arena is becoming increasing necessary.

## **8.6 Improvement Implementation**

ENL has identified the following contributors affecting the ability to improve in these areas...

- Re-sourcing and maintaining the necessary skills and skill balance for internal staffing, external consulting and local contracting resources
- Provision of sufficient and suitable resource to ensure accurate and timely information capture, used as inputs to the prediction and forecasting processes used for management of the assets.
- Correct use of appropriate and efficient technologies including tools and equipment to optimise asset construction, condition assessment and maintenance costs.

- The level of involvement within the local community and at the policy making level.

With a shortfall in available resources which is more significant in the local region ENL is actively contributing to training and development of new resource from entry level to ensure improvement in the long term.

ENL has a technology focus and is active in identification and development of equipment and systems designed to offset the short term re-sourcing short fall.

Membership, strategic partnership and alliances are being developed in the short to medium term to improve ENL's understanding and input into the direction of the industry.

## **A1. Feeder loadings**

Feeder loadings since 1 December 1998 are shown below. Note some zone substations require more than one chart.

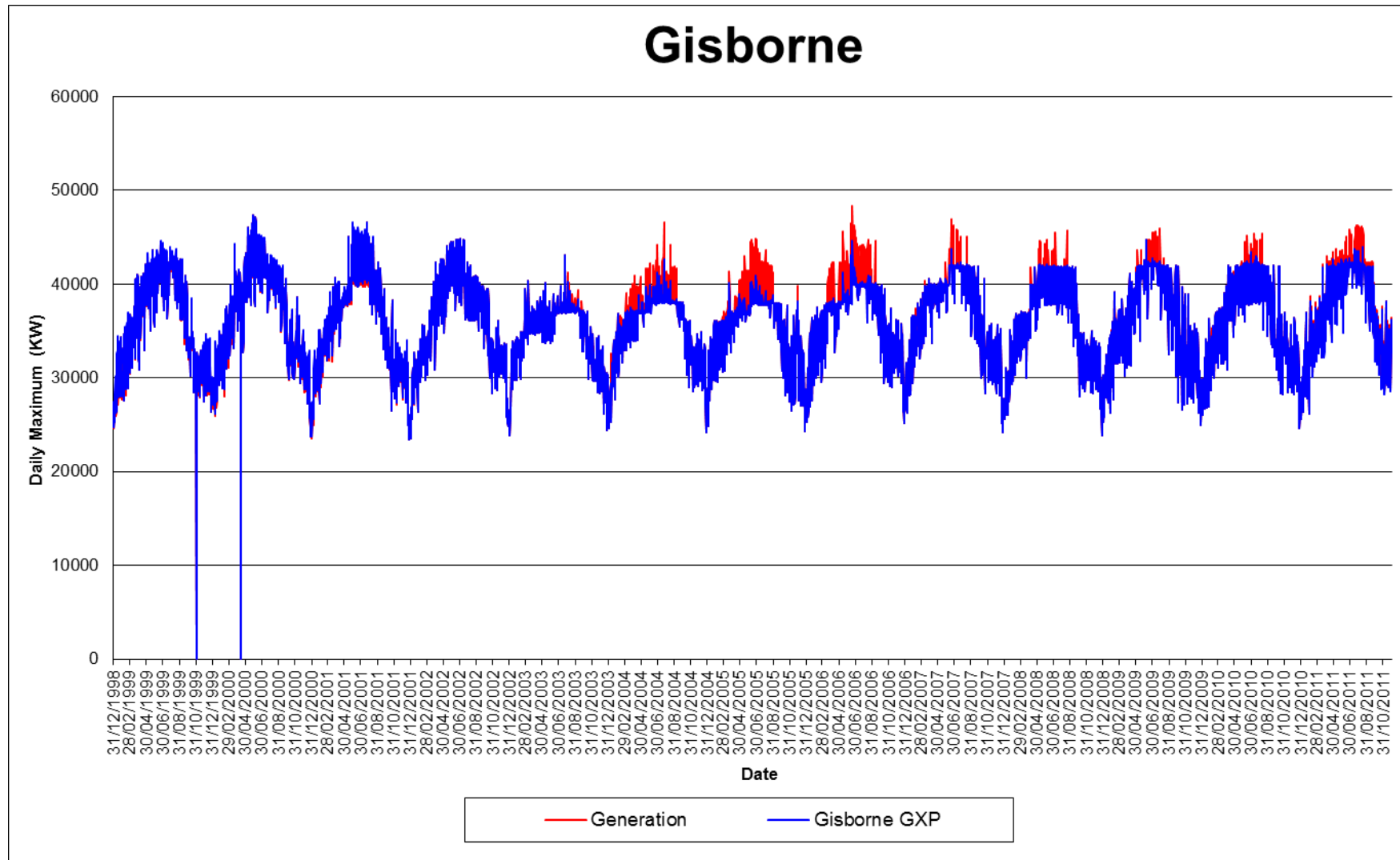

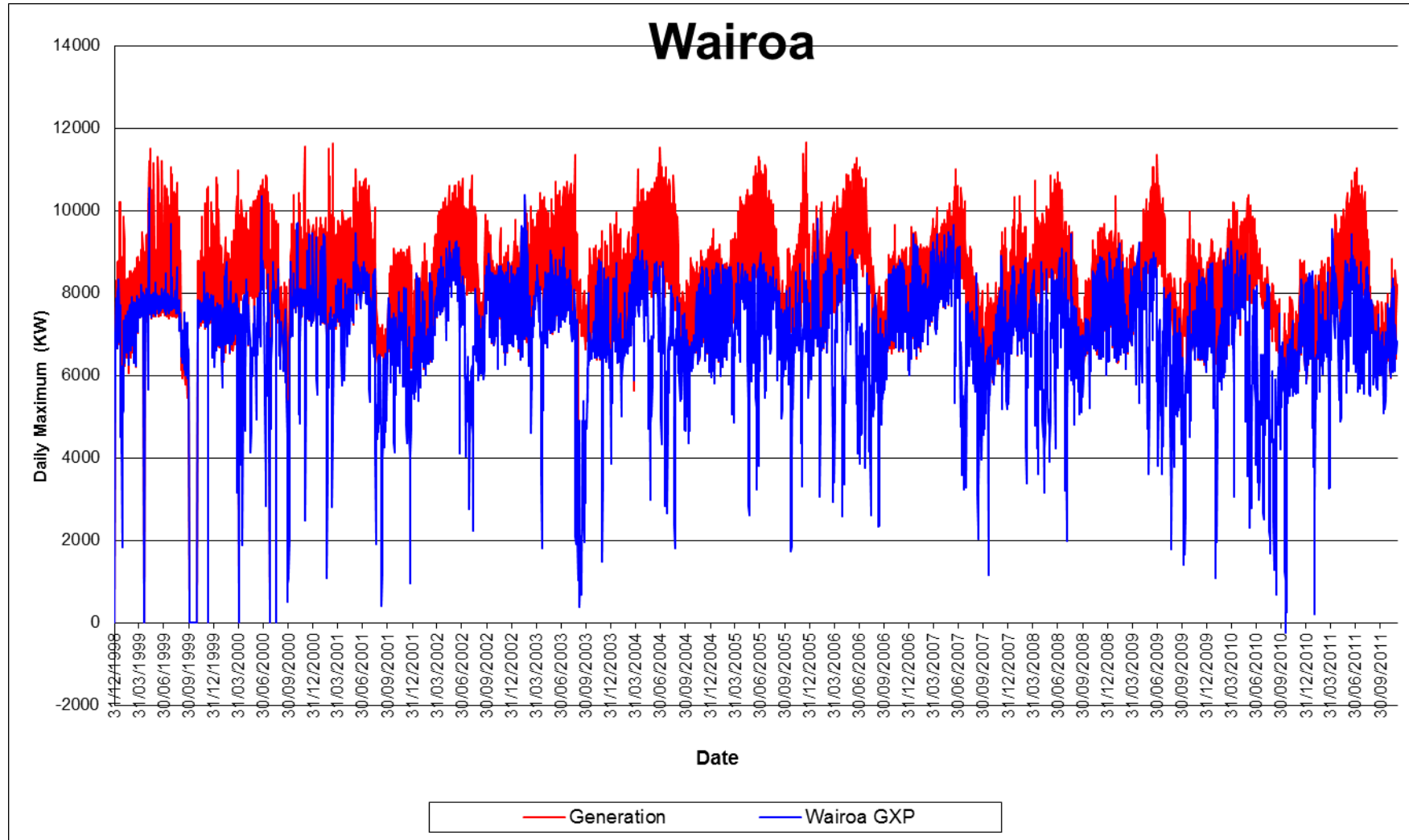

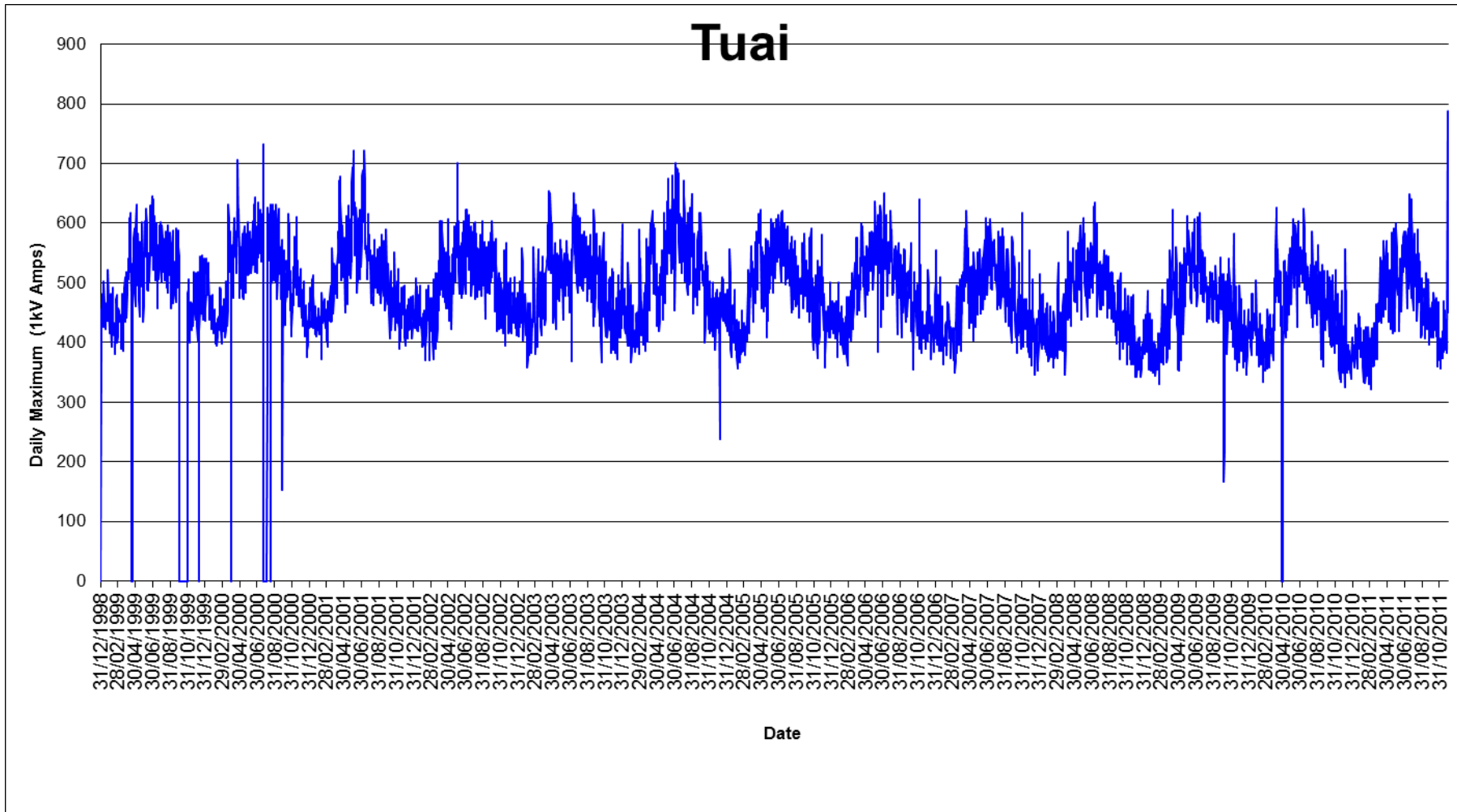



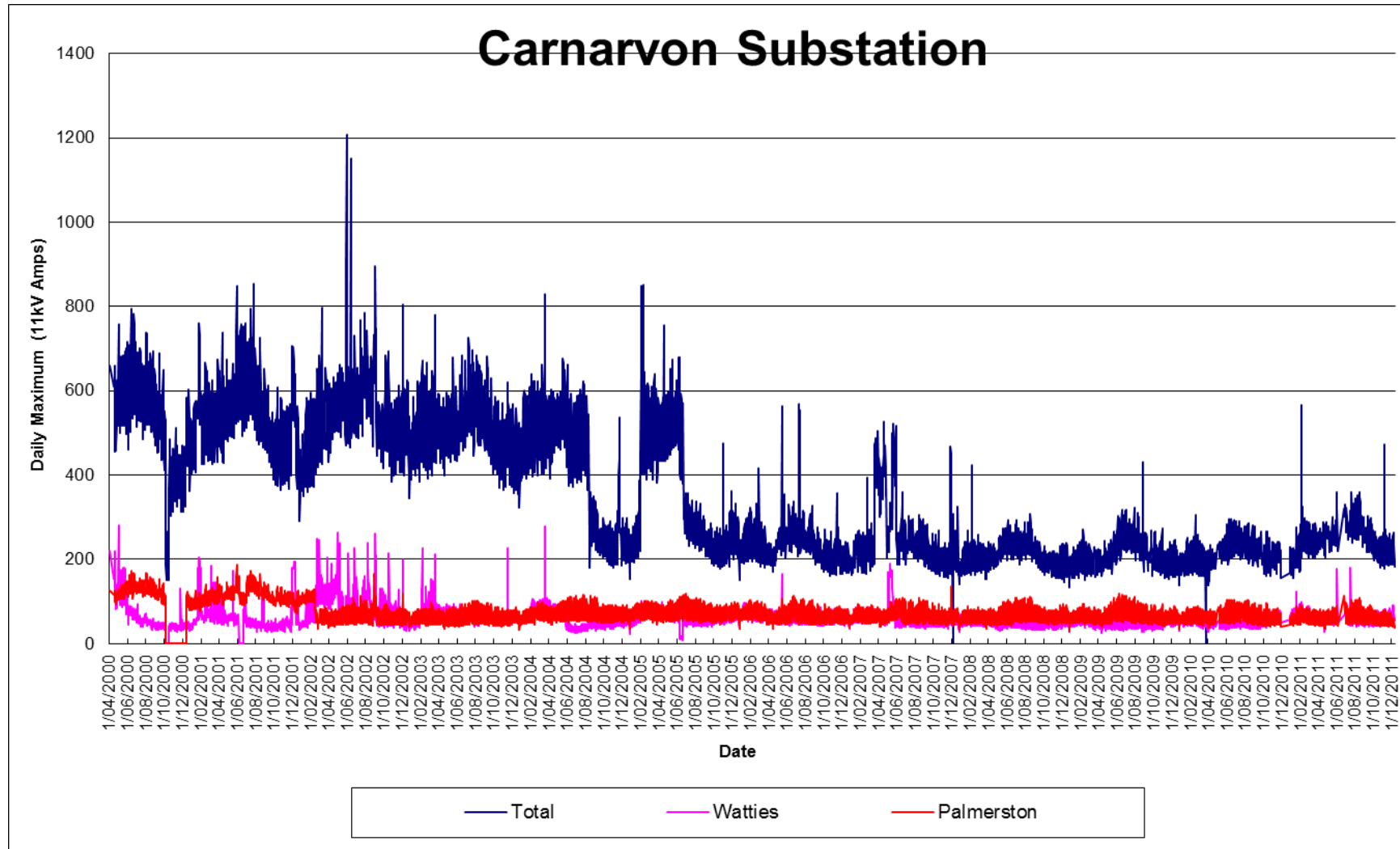

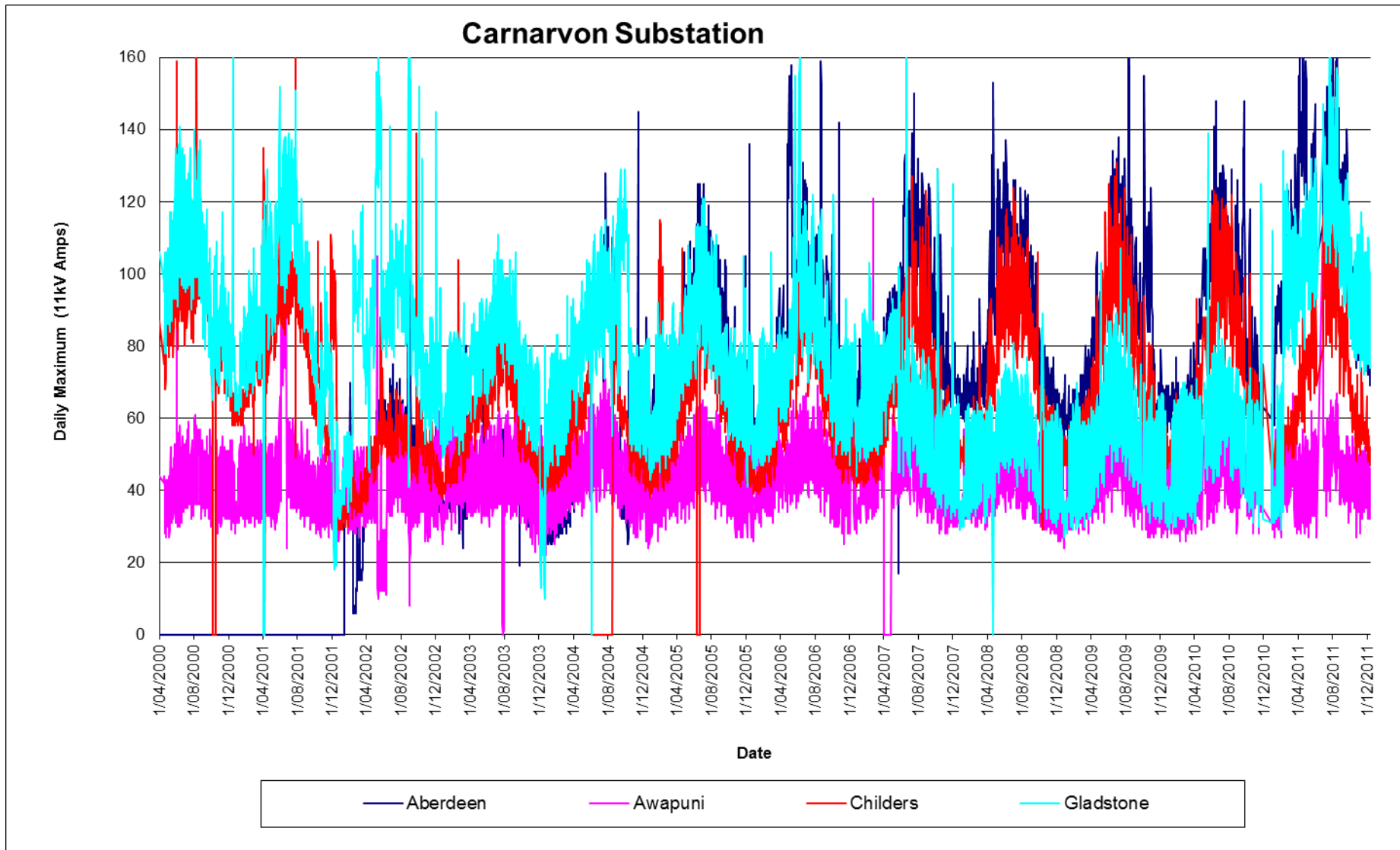

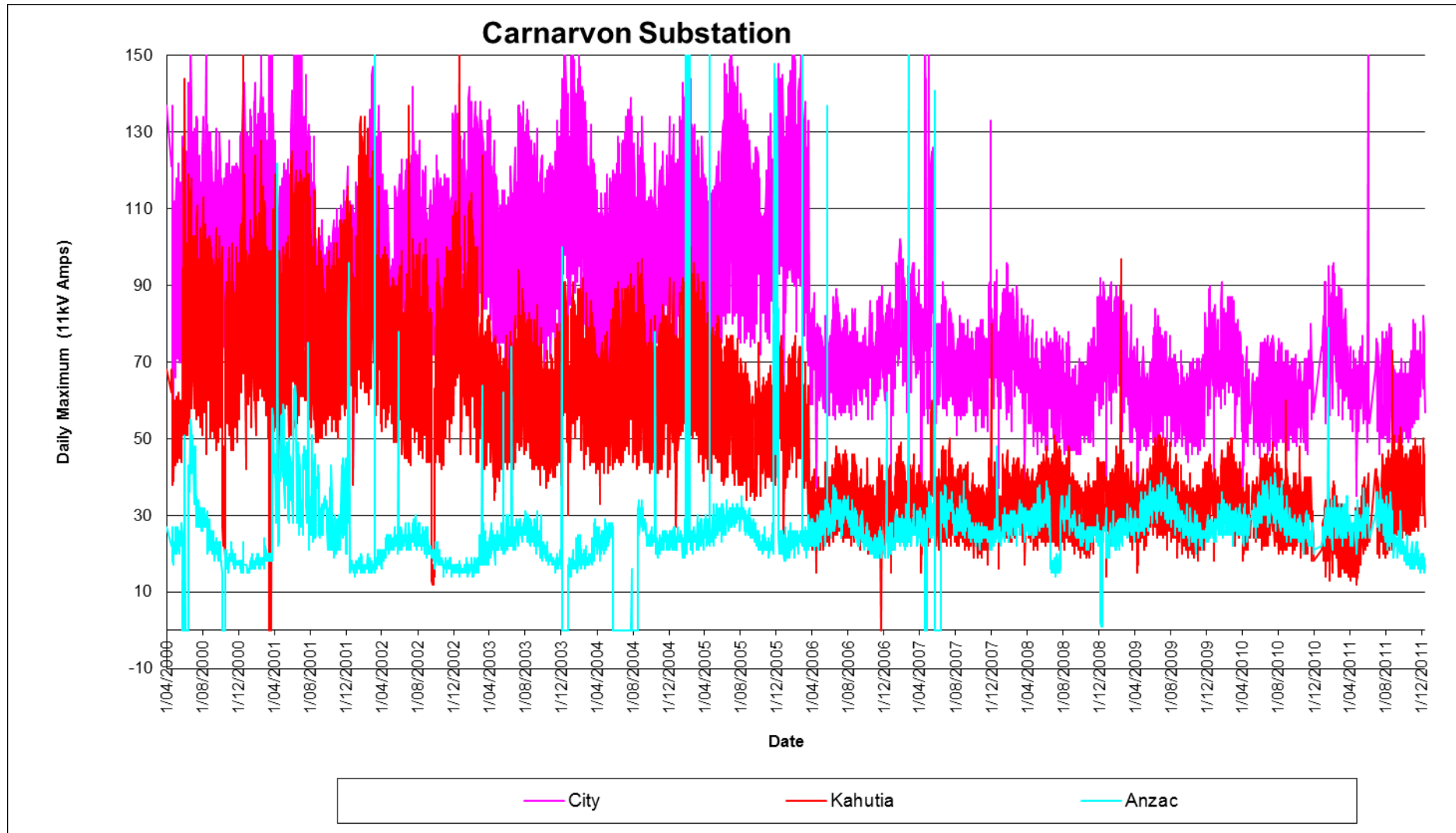

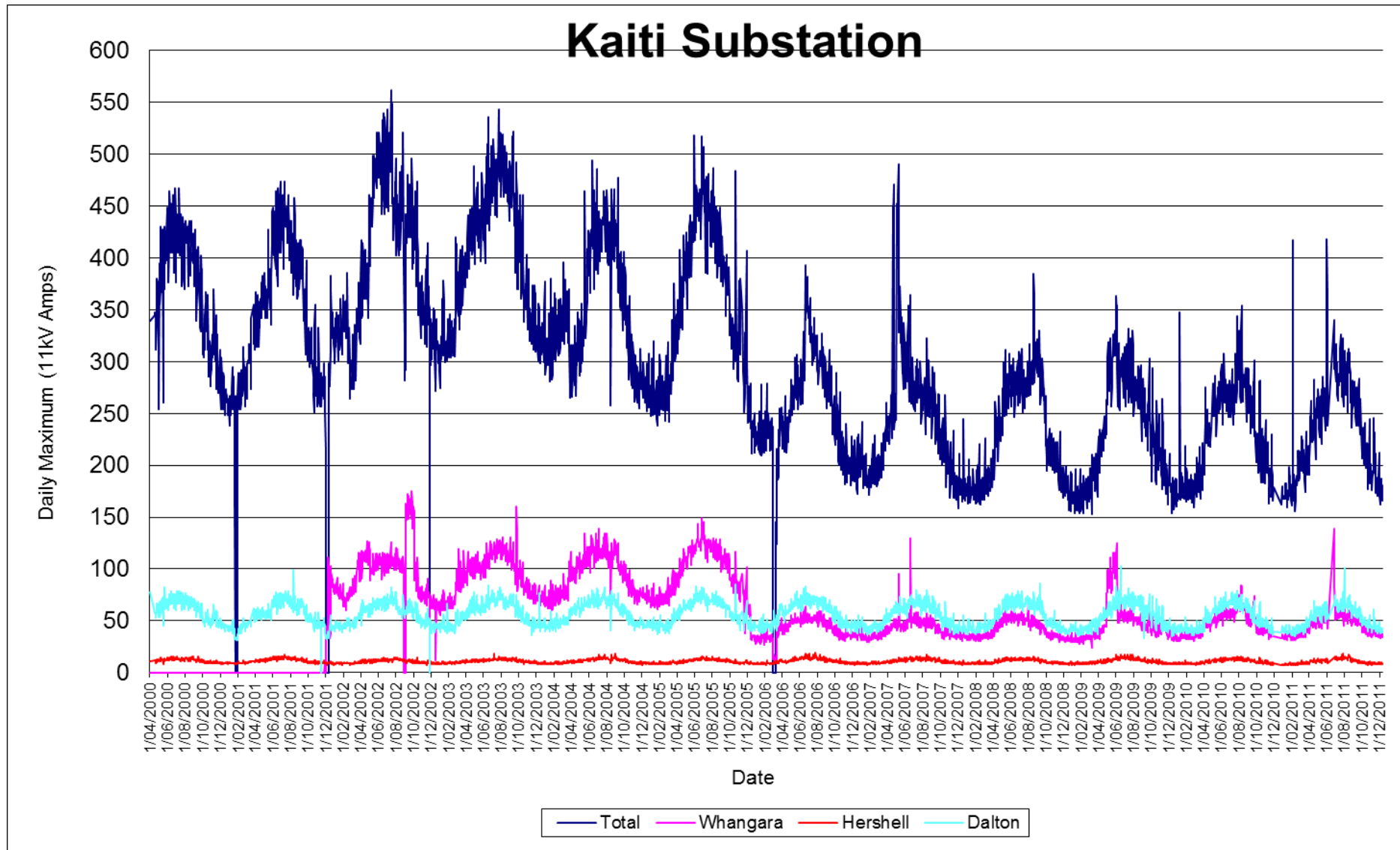

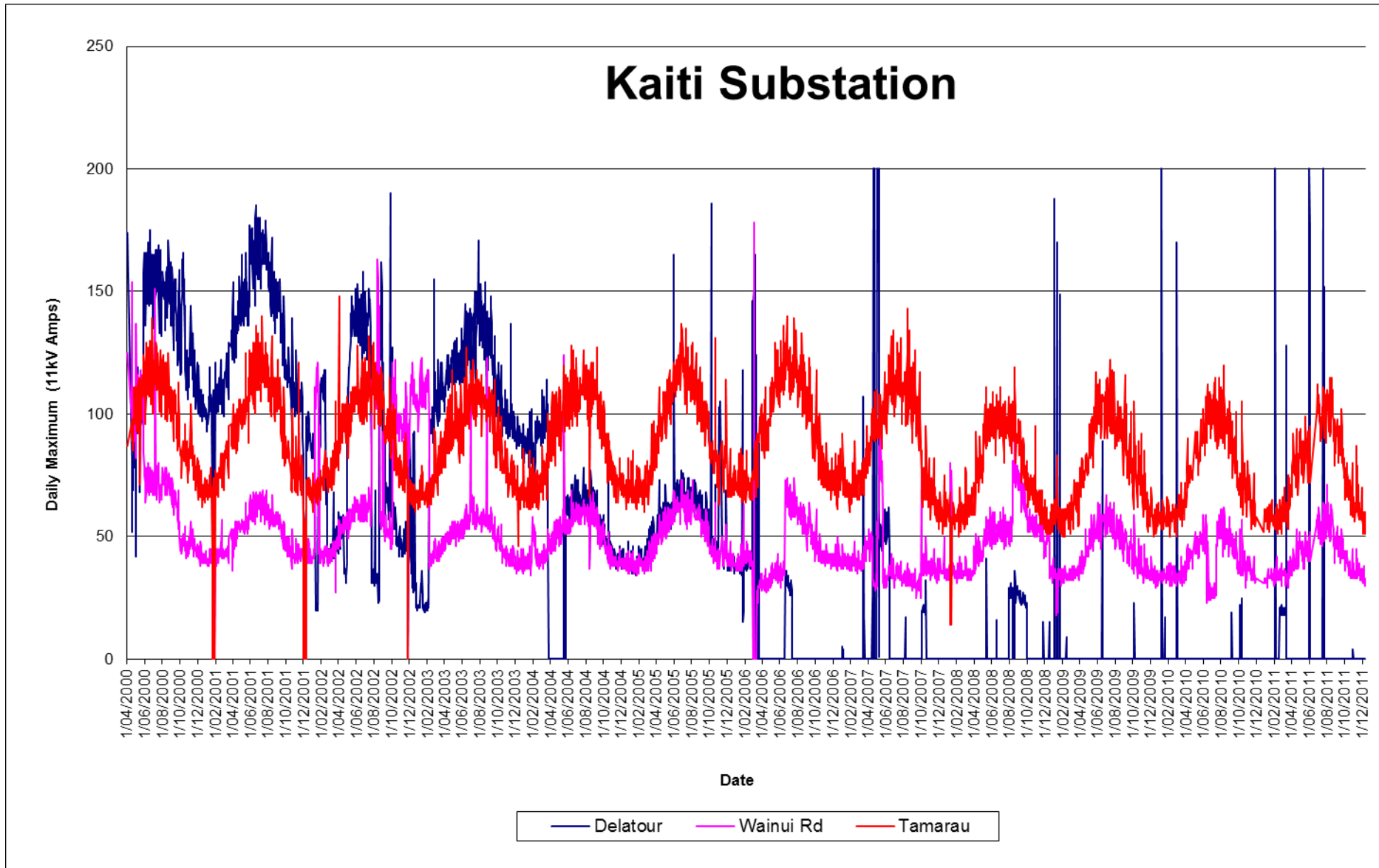

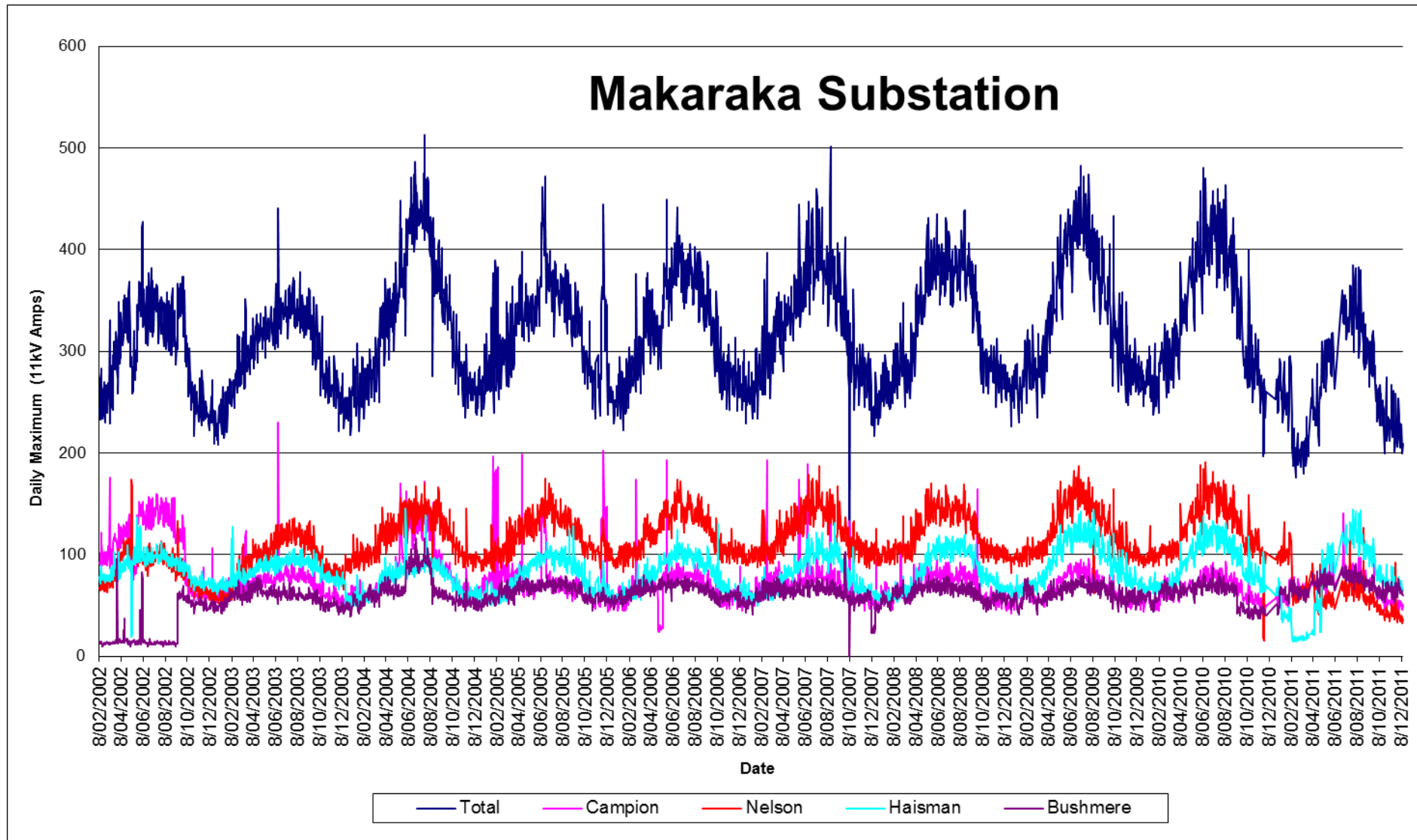

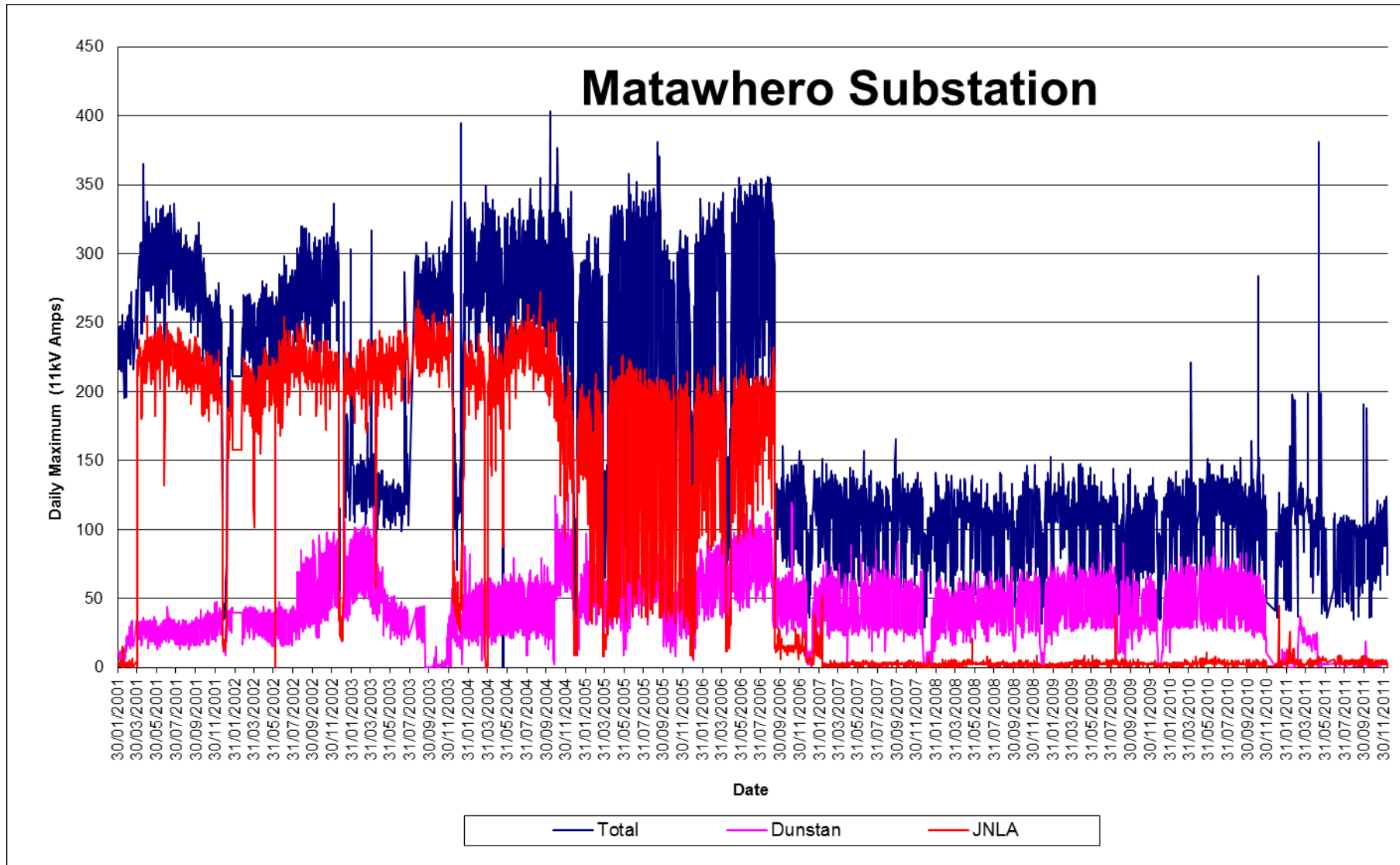

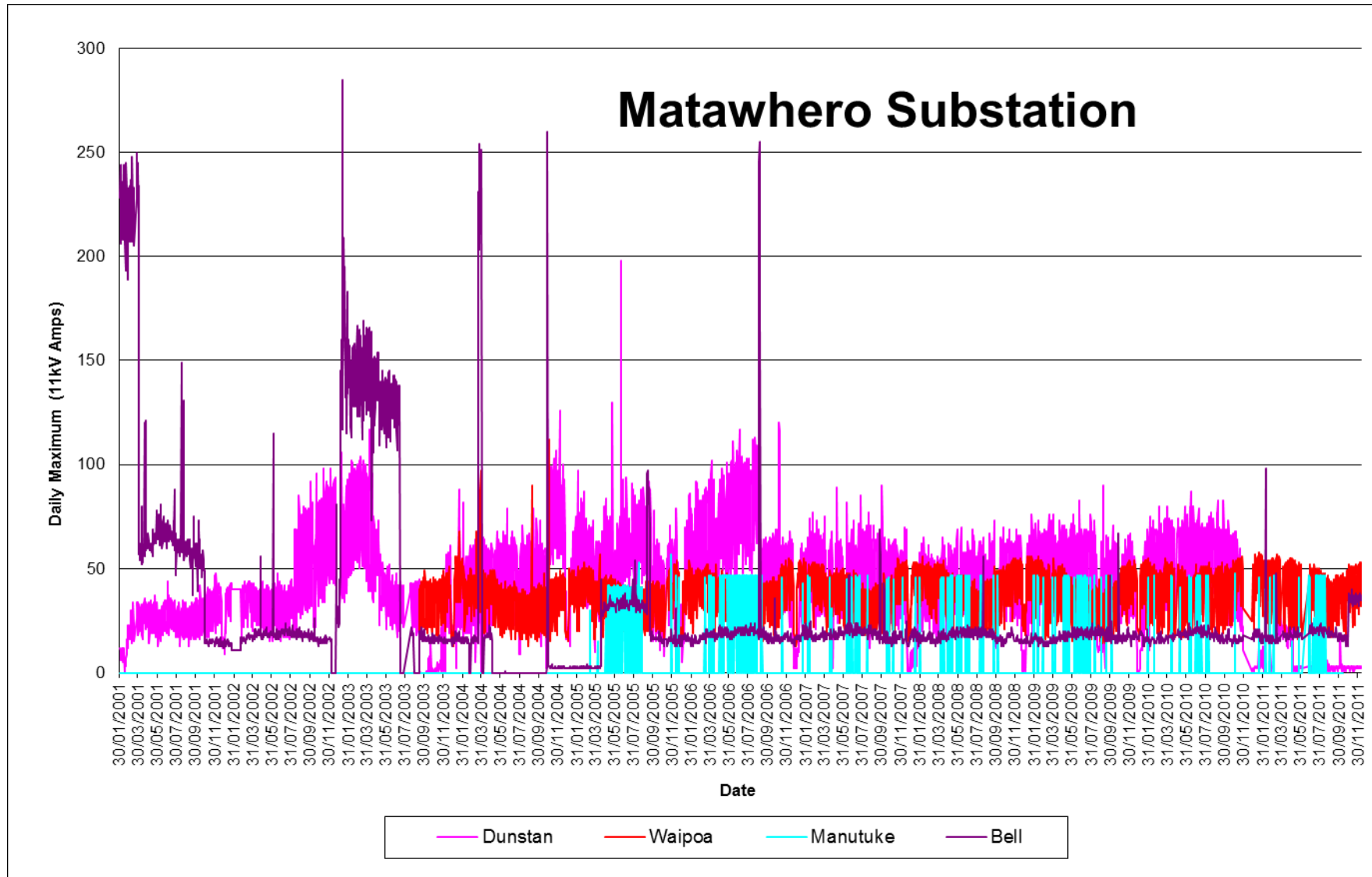



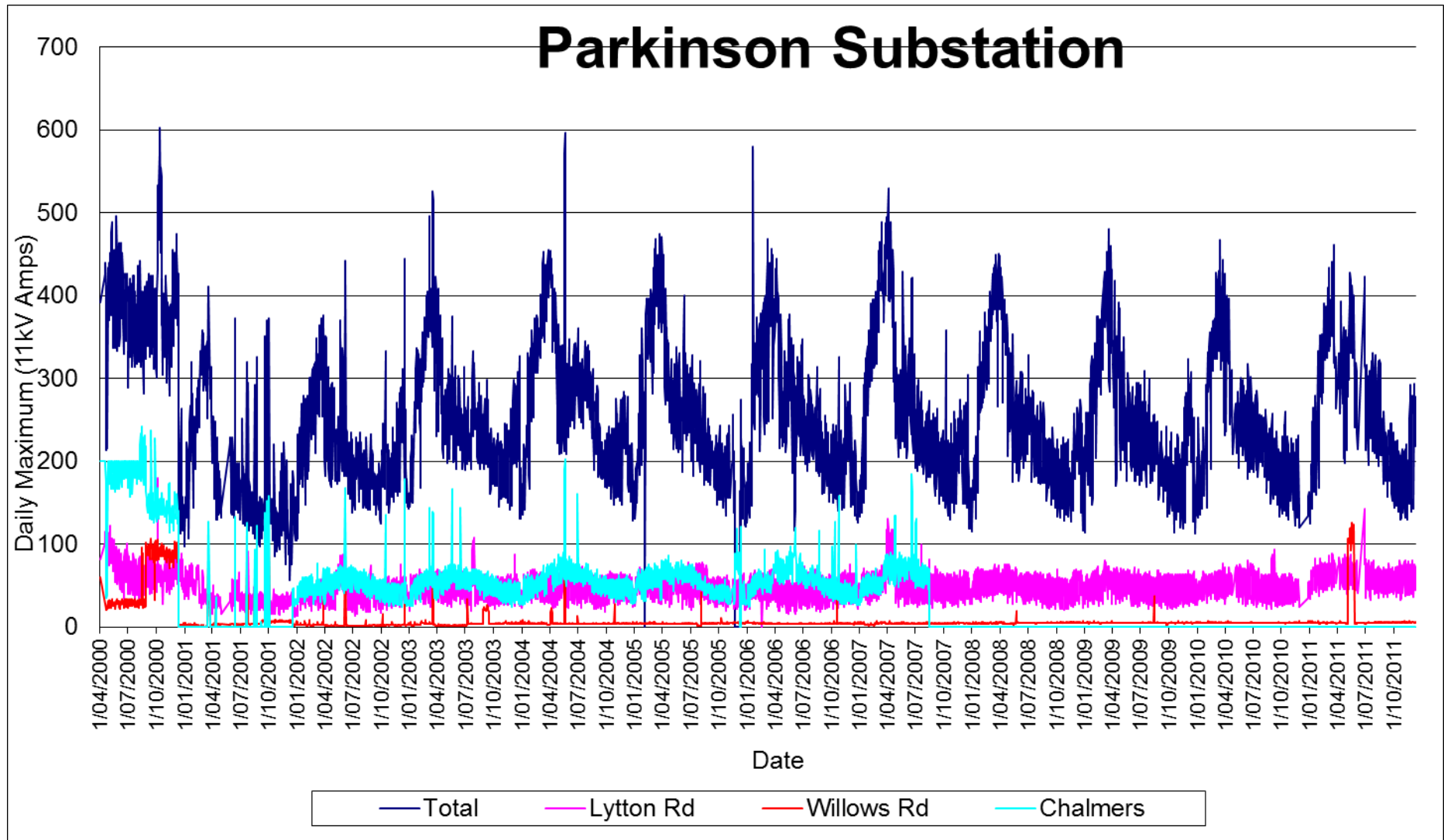

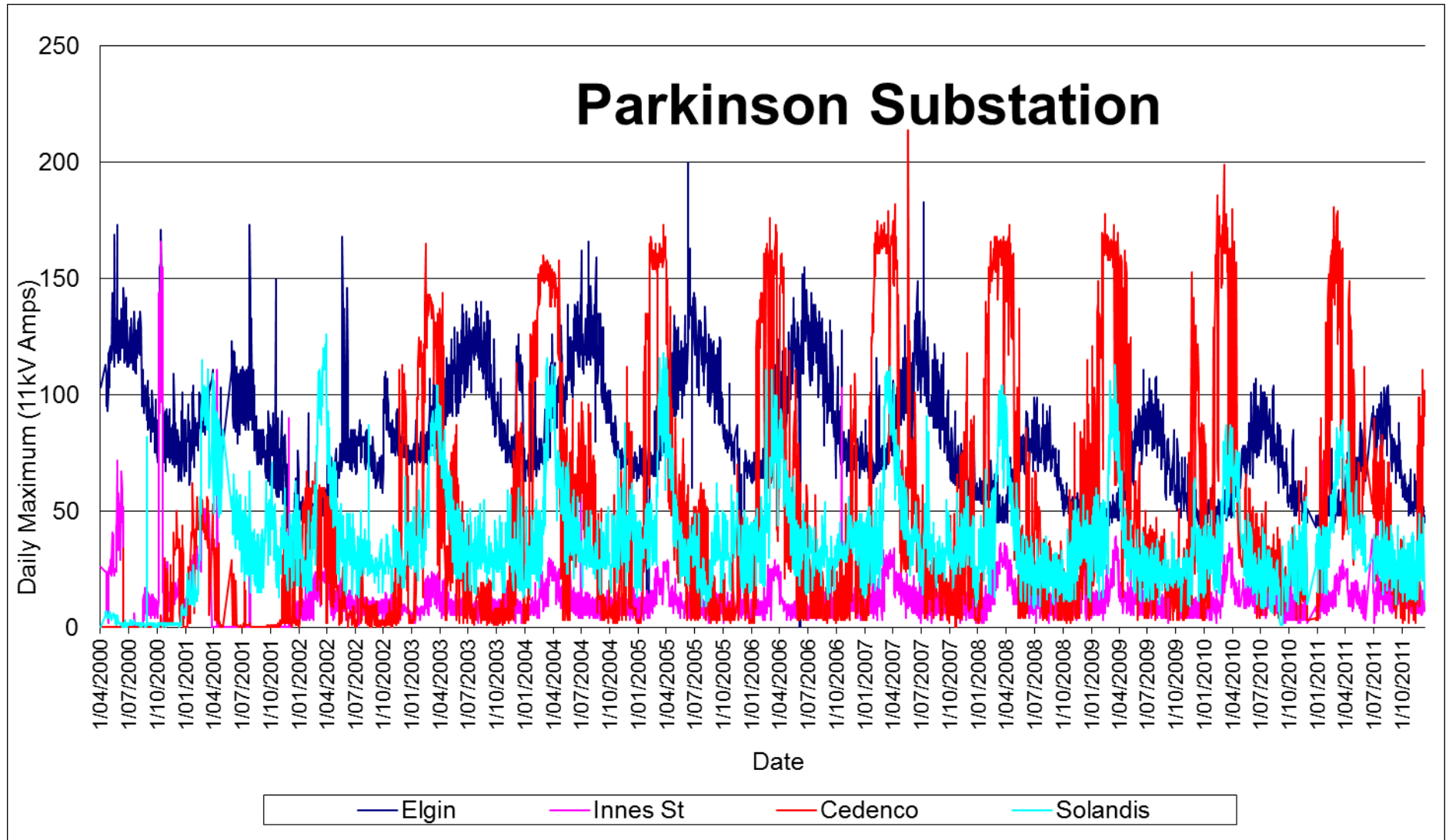

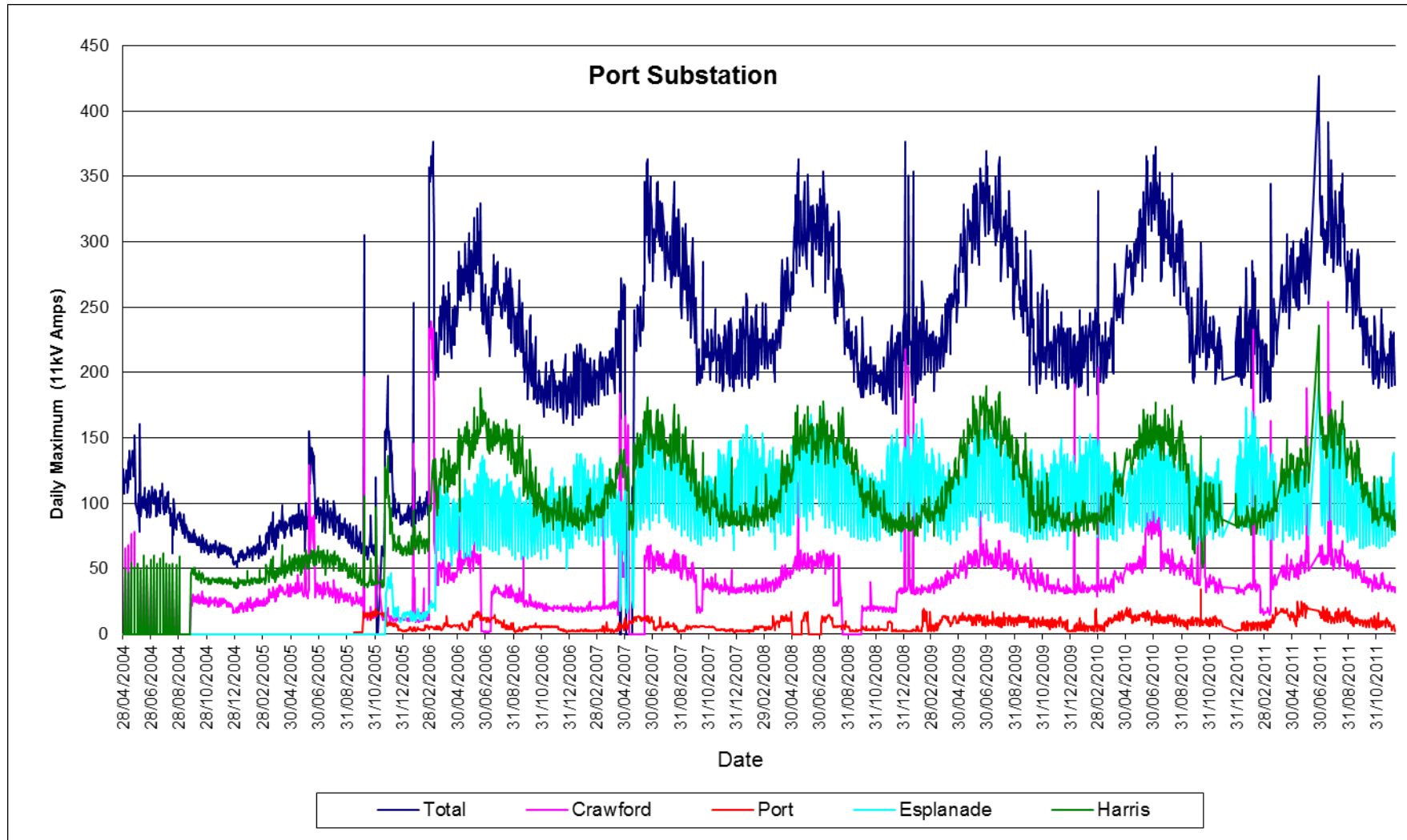

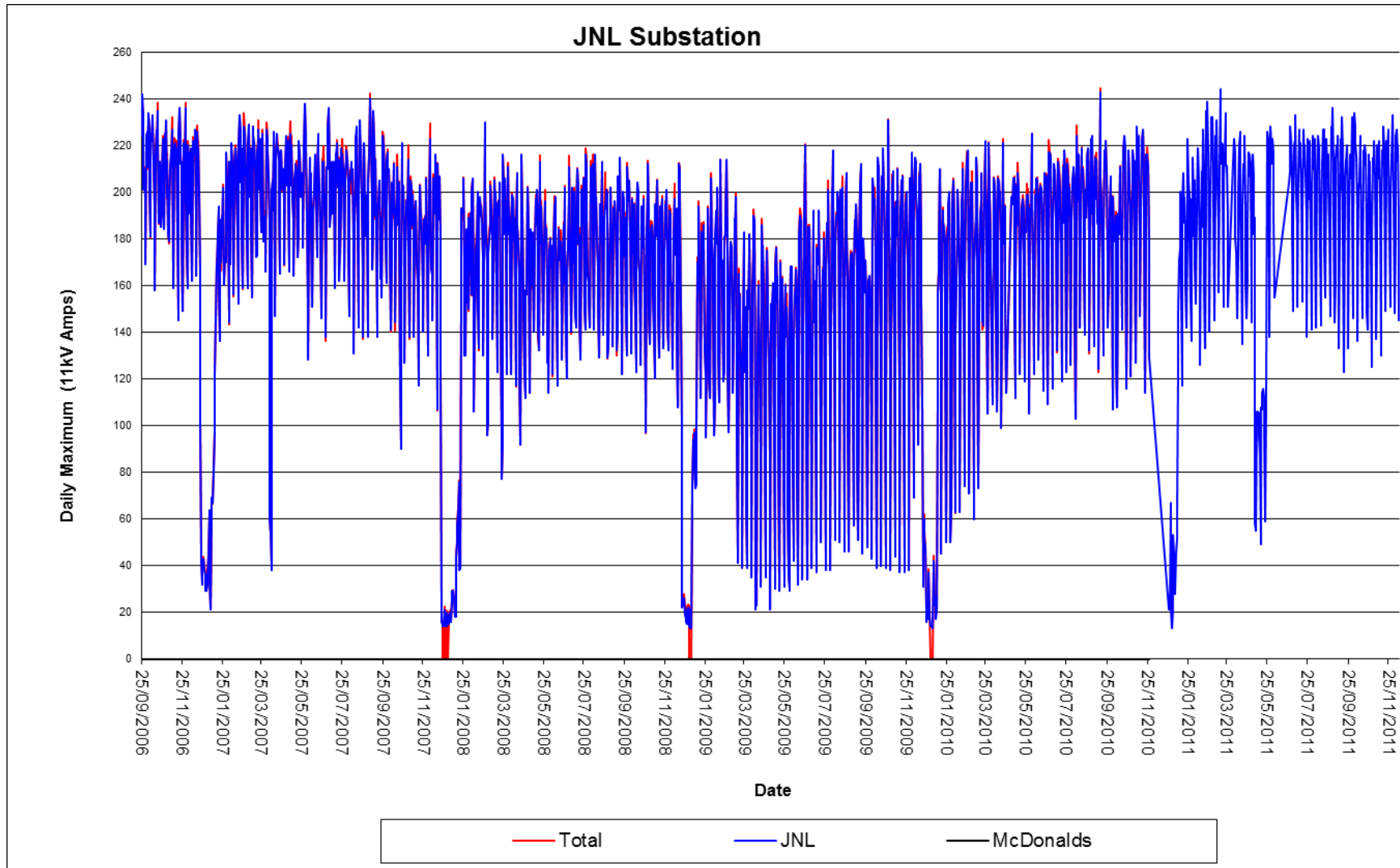

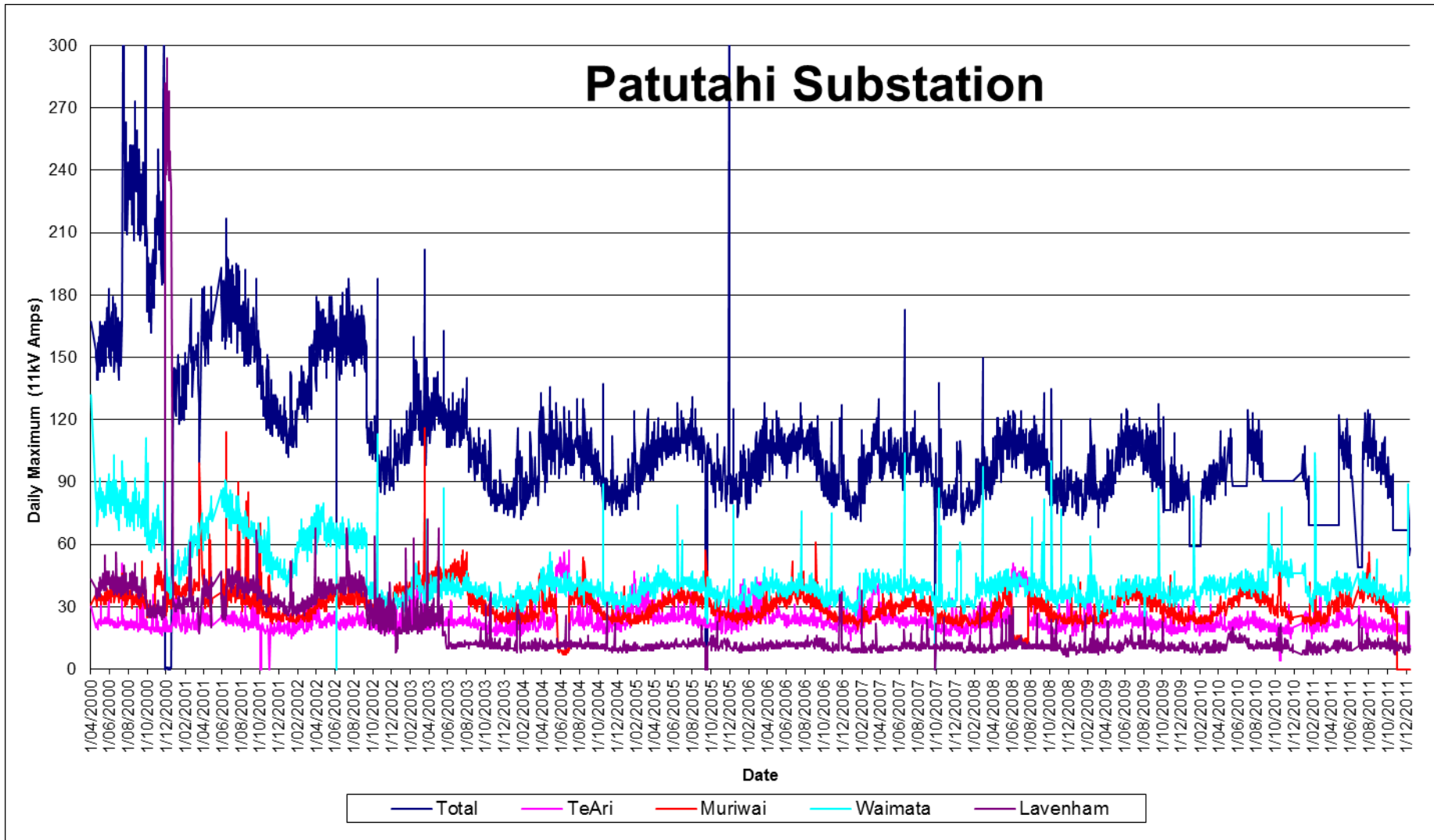

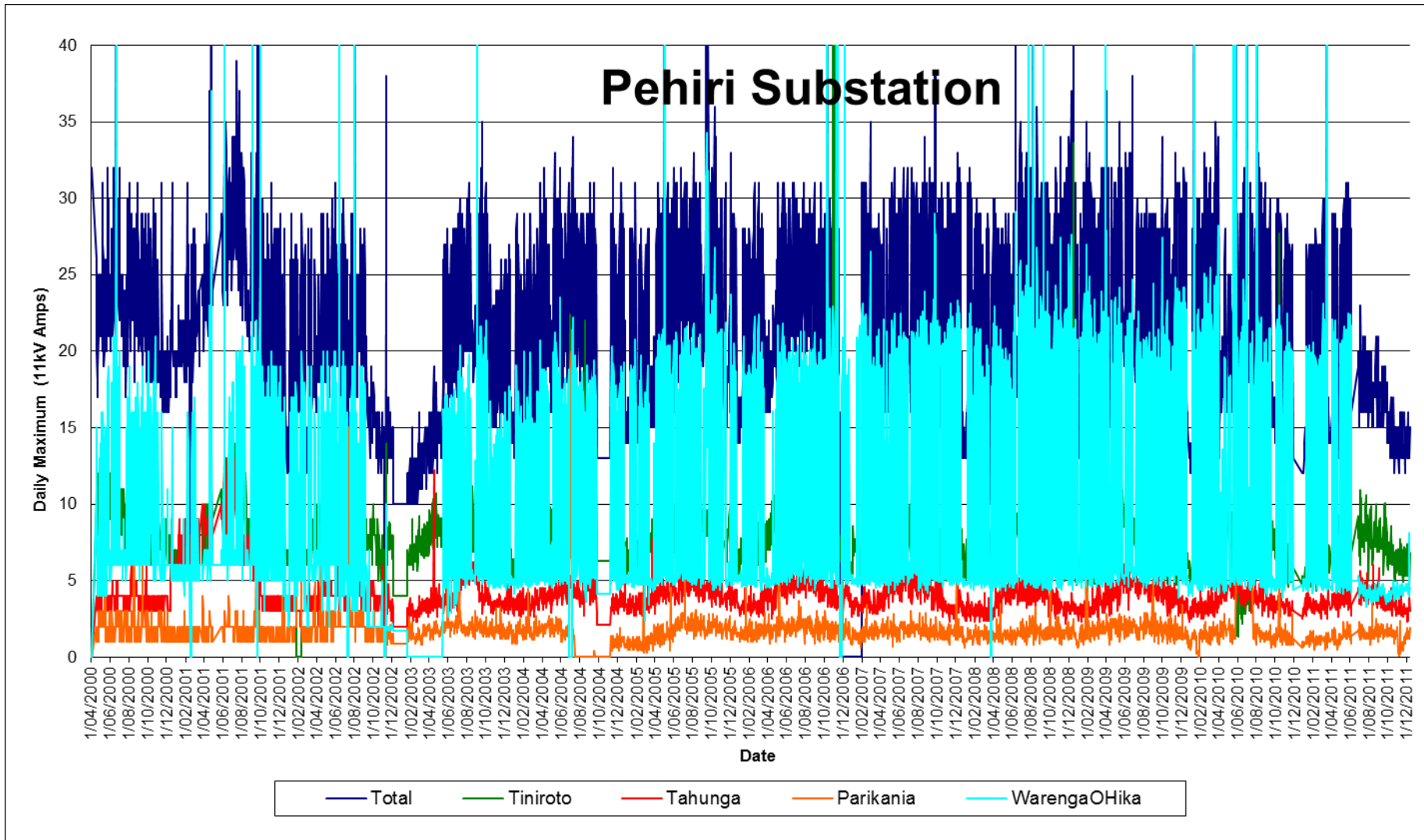

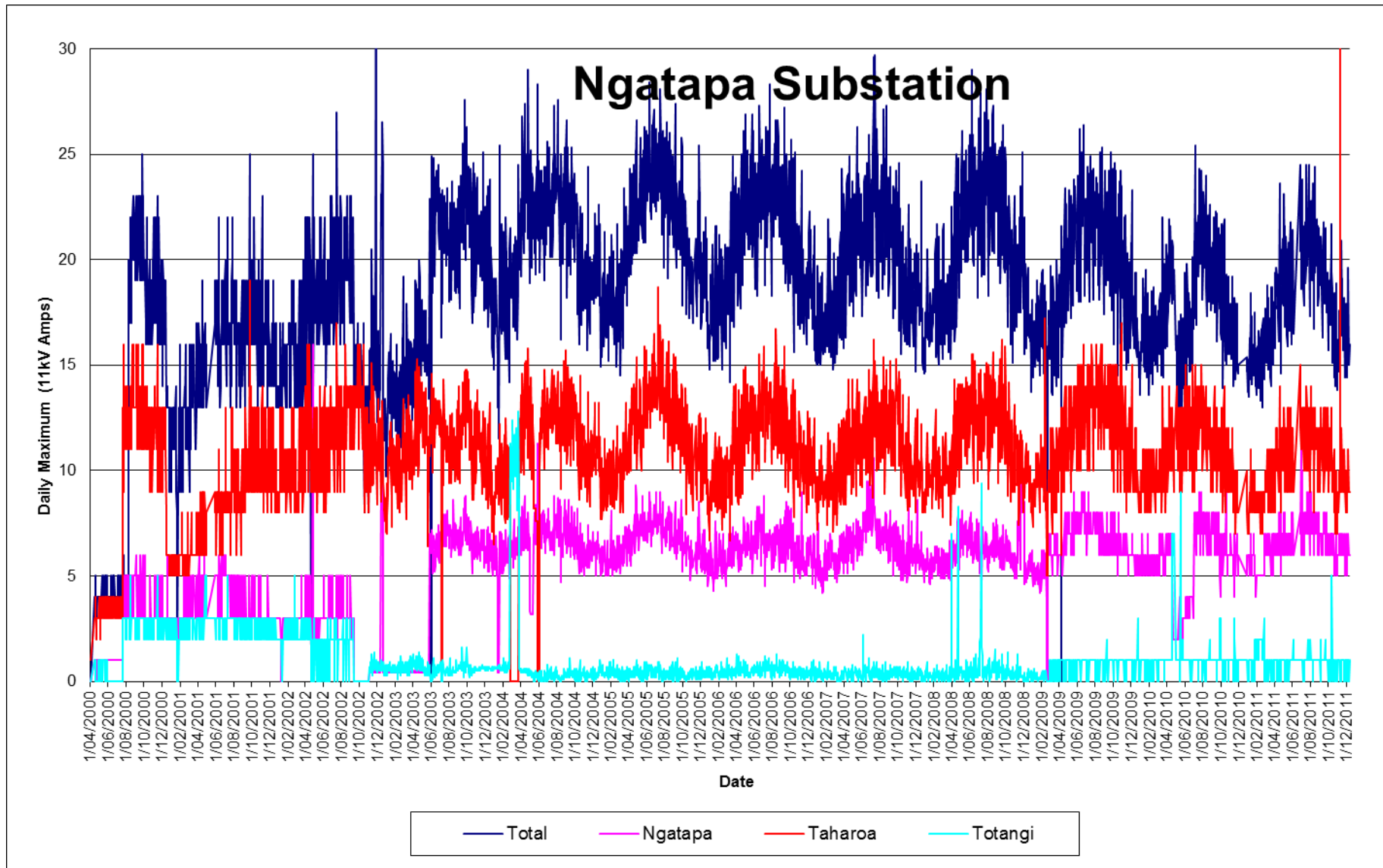

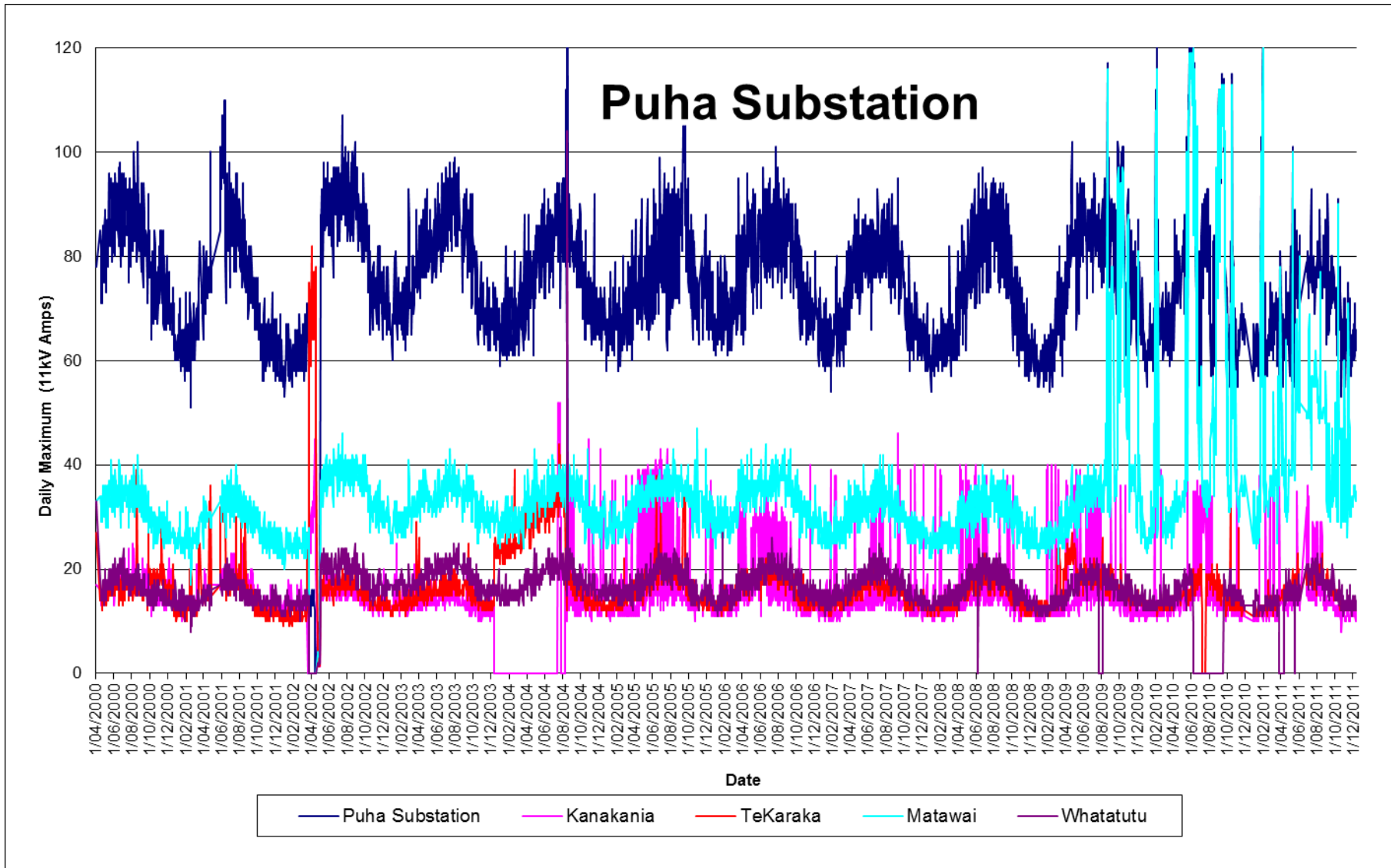



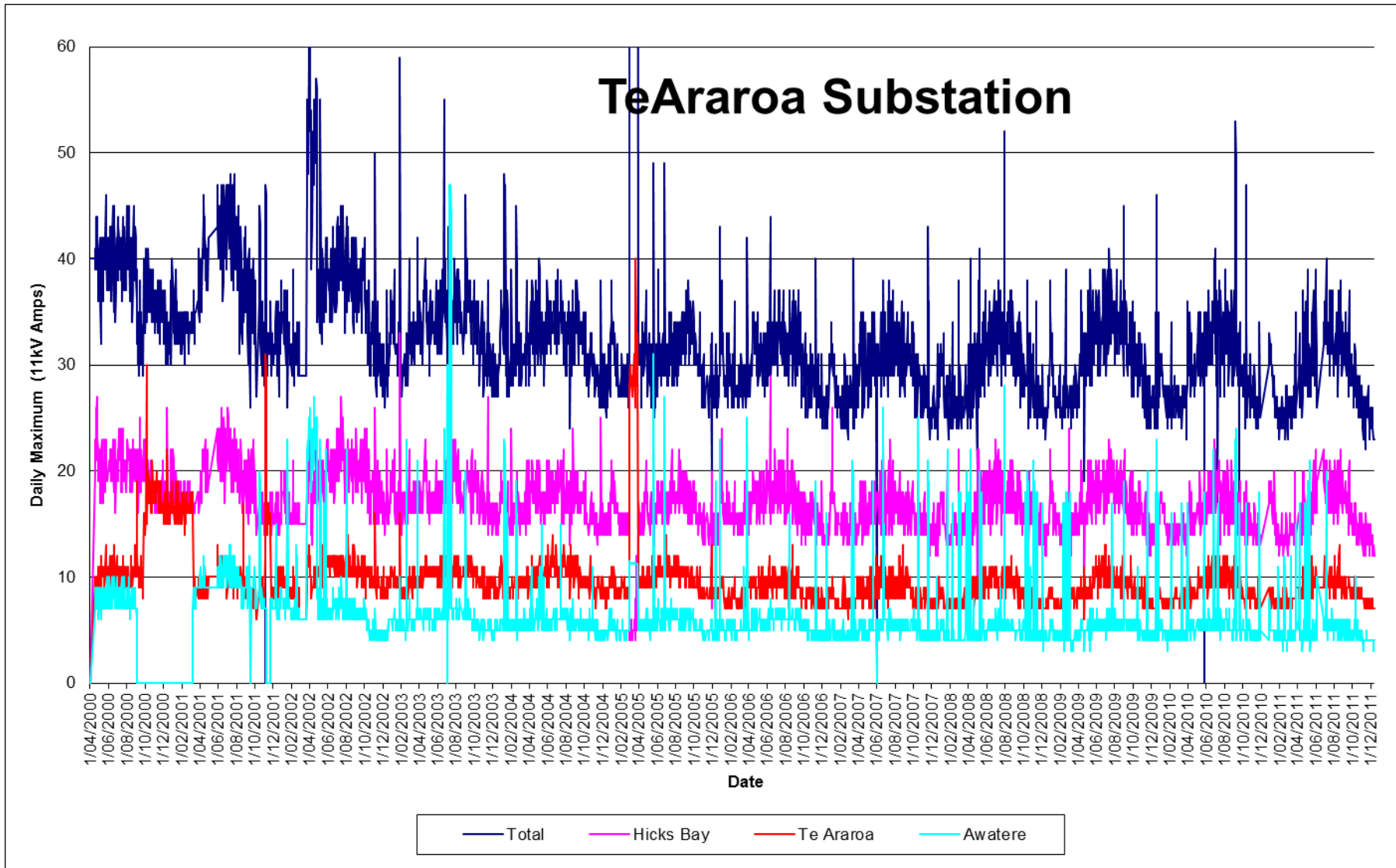

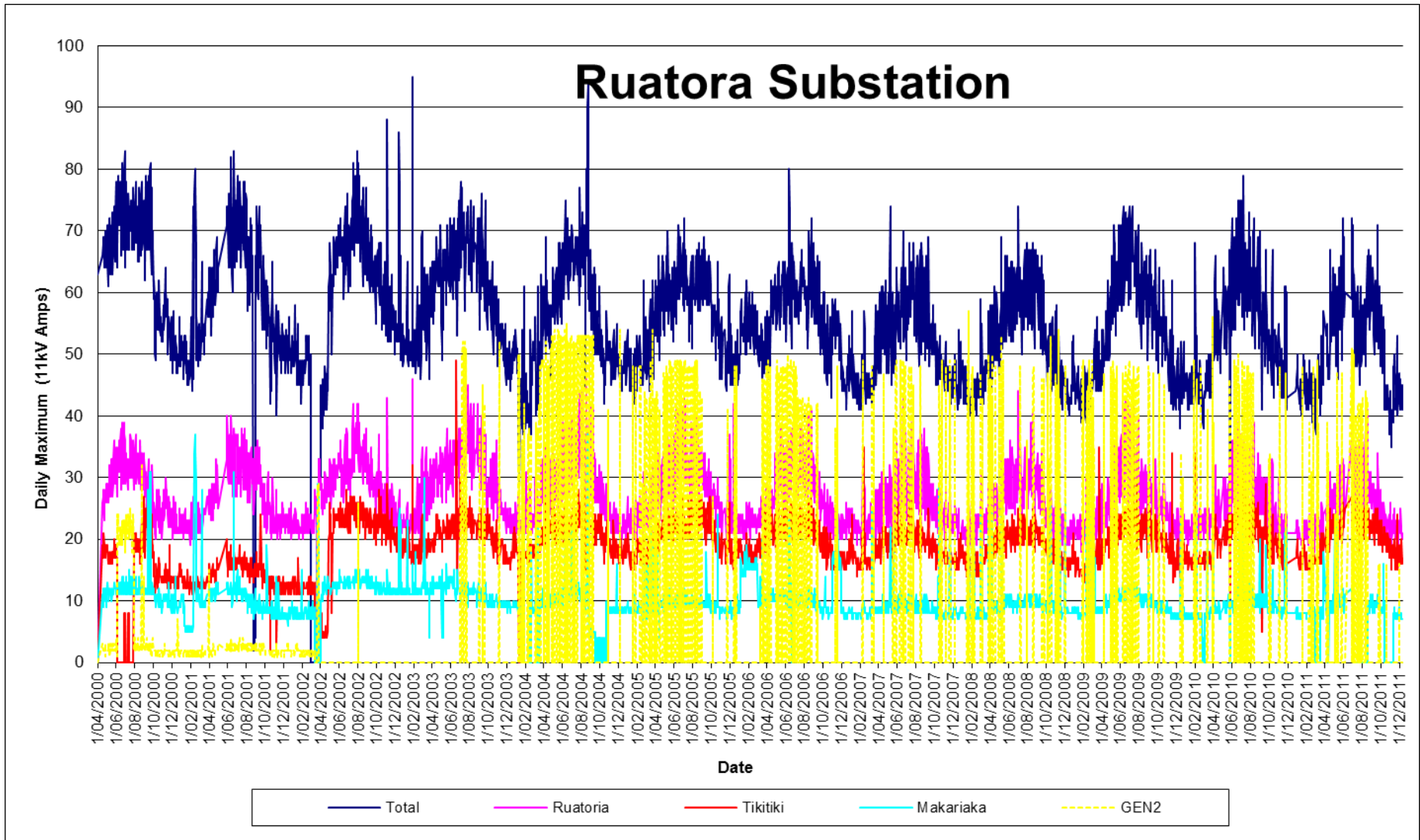

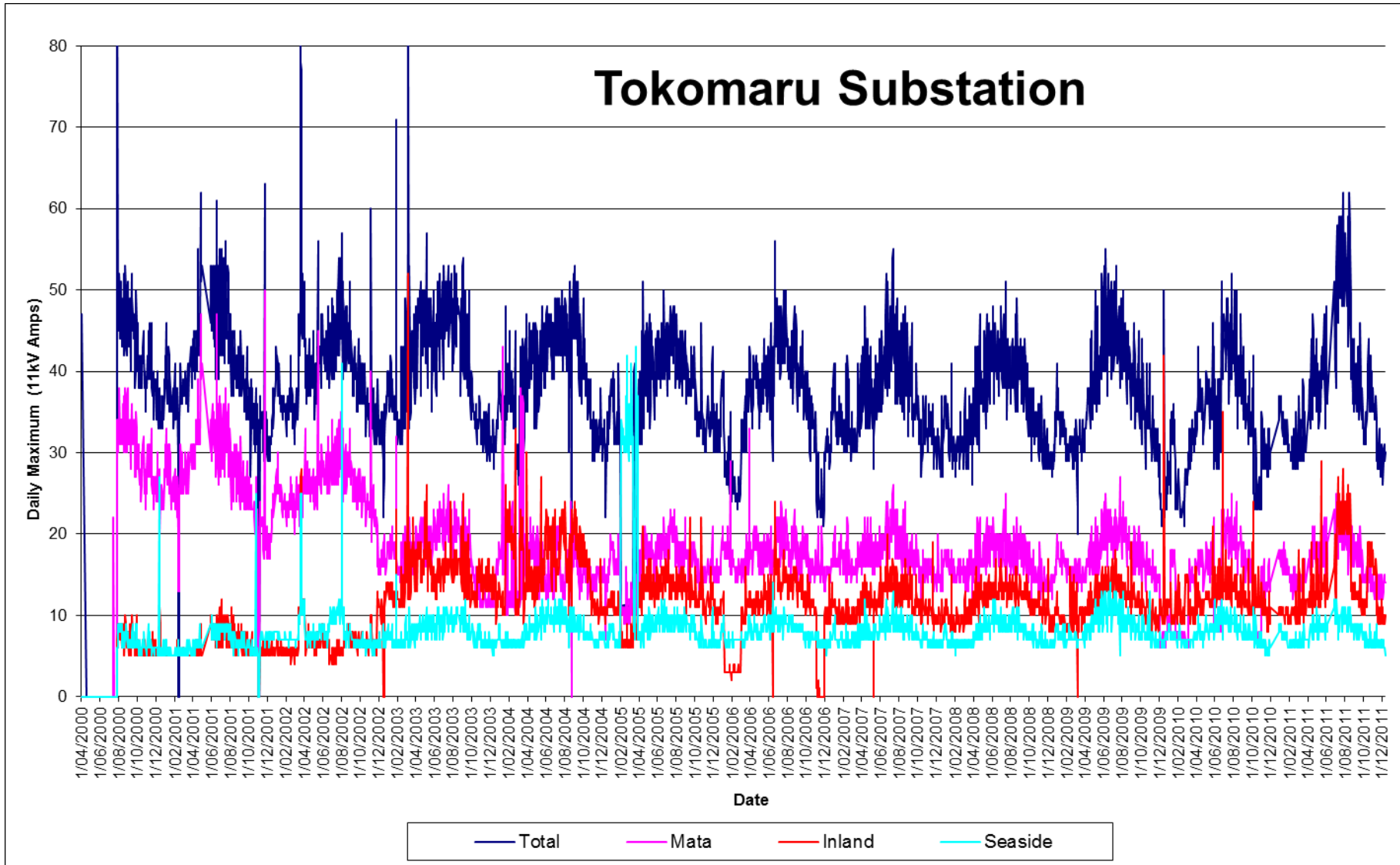

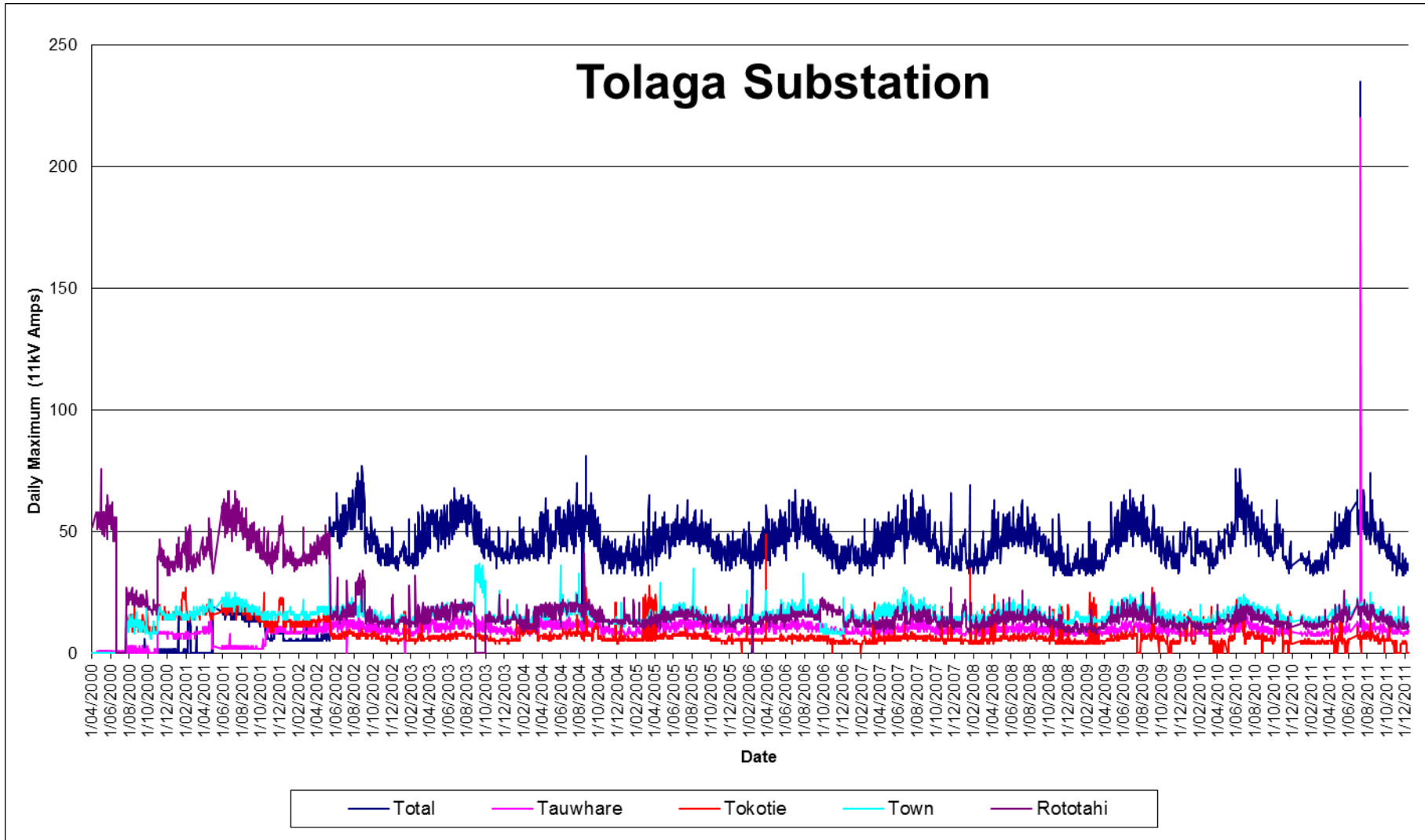

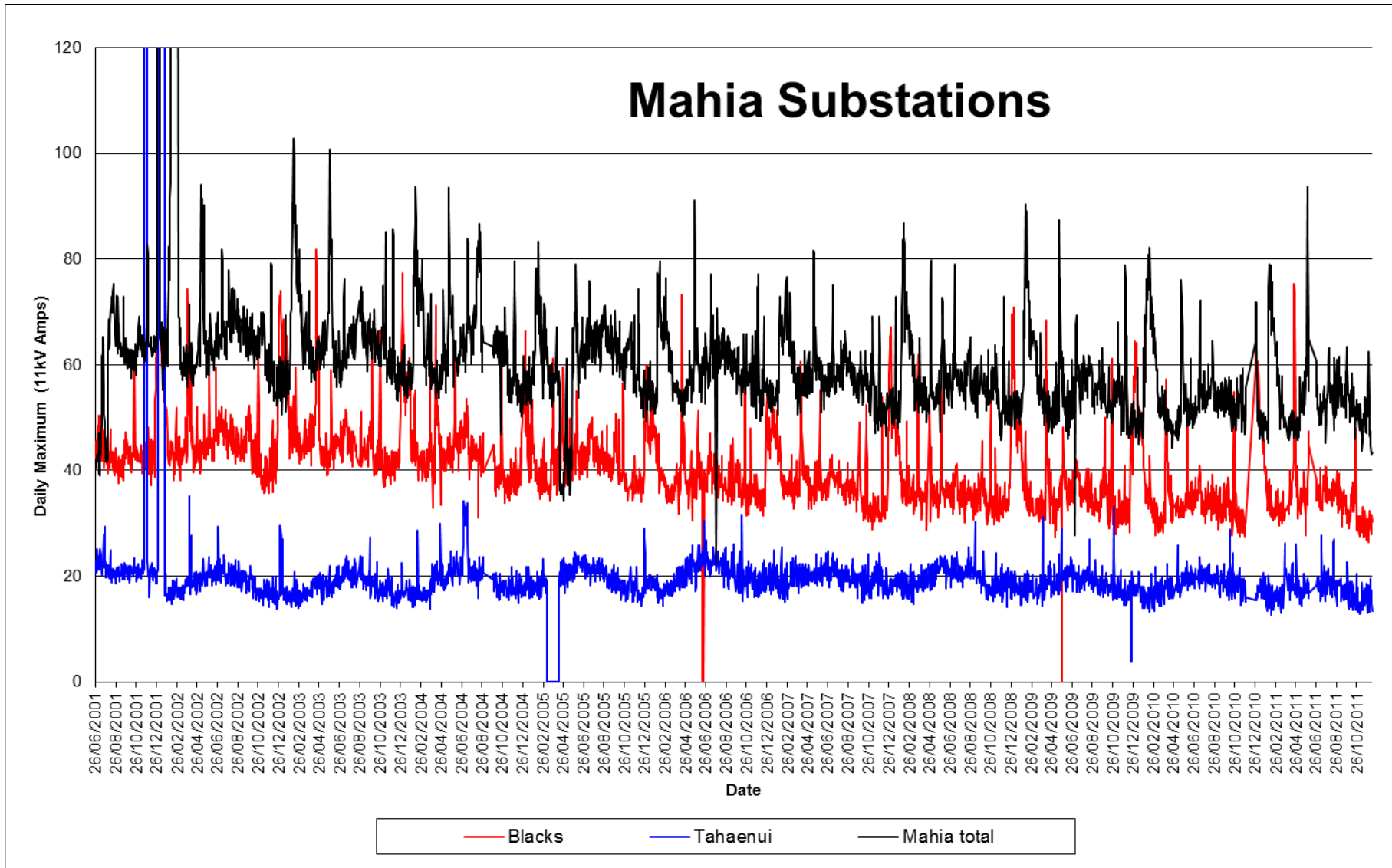

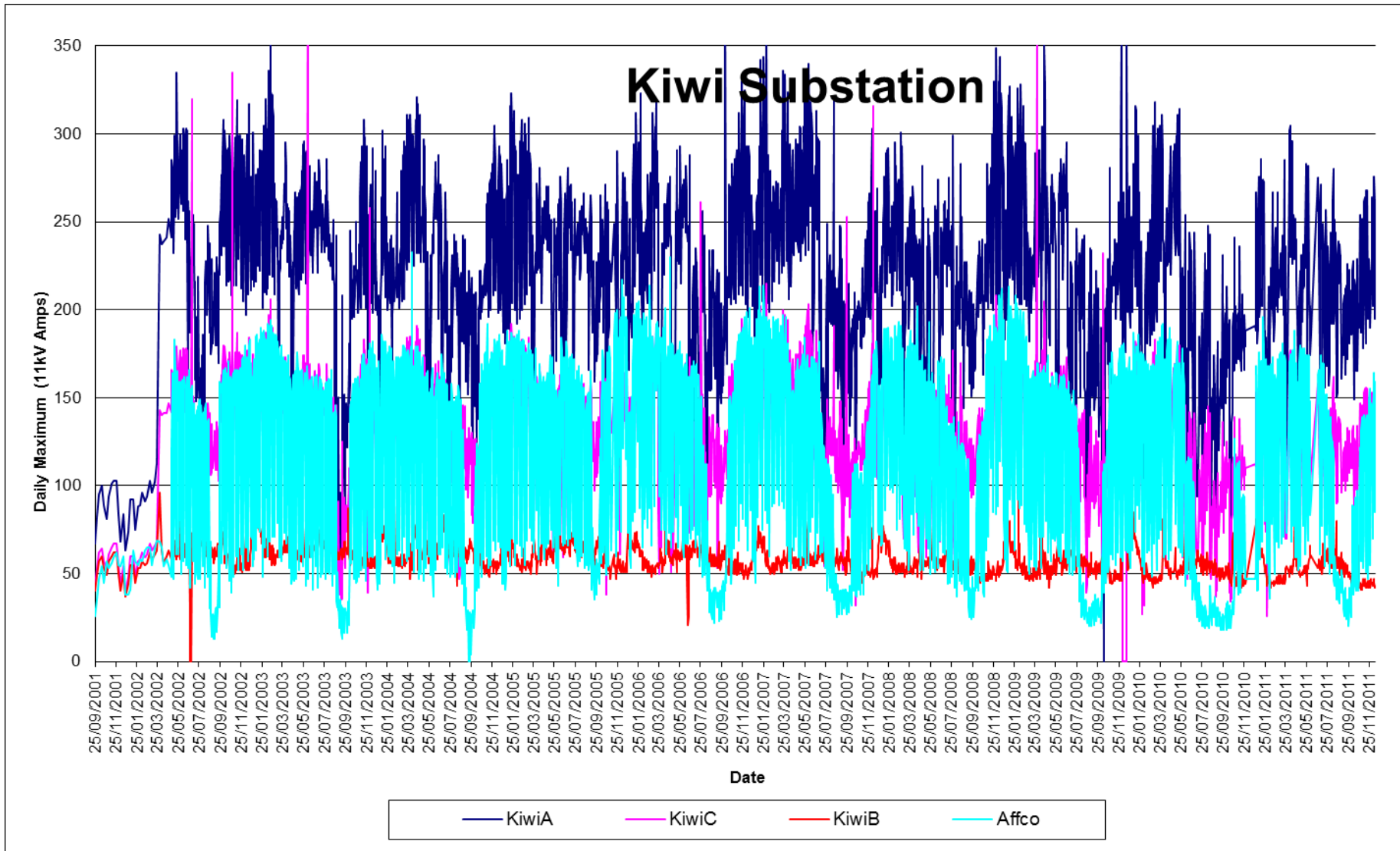

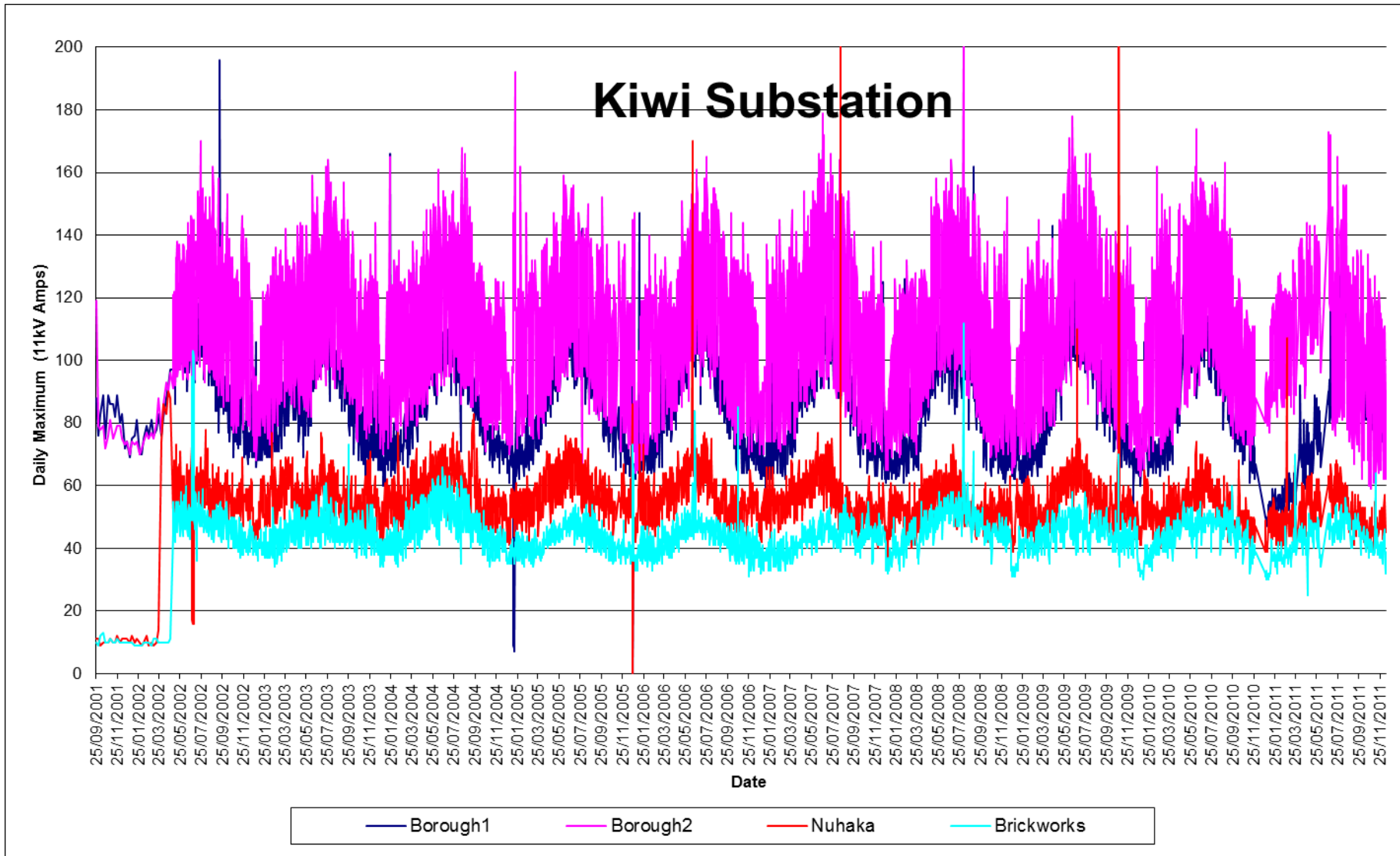

## **A2. Disclosure Requirement 7(2)**

The Electricity Distribution (Information Disclosure) Requirements 2008, gazetted in October 2008 introduced a new requirement in relation to AMP information. In addition to the information to be included in the AMP, as prescribed in the Electricity Information Disclosure Handbook, dated 31 March 2004 and amended 31 October 2008, ENL is required to disclose the following information. This statement comprises ENL's disclosure in accordance with this Requirement.

*(a) all significant assumptions, clearly identified in a manner that makes their significance understandable to electricity consumers, and quantified where possible;*

A number of significant assumptions have been made in order to determine likely outcomes of ENL's AMP. These key assumptions are summarised as follows...

- Ownership- ENL's ownership is assumed to remain unchanged throughout the planning period.
- Corporate Vision, Objectives and Targets – ENL's corporate vision, objectives and targets in section 1.2 are assumed to remain the same throughout the planning period.
- Climate - ENL assumes normal climatic variation over the planning period including temperature, wind, snow and rain patterns consistent with its experiences since 2000.
- Major disasters – The assumption has been made that major disasters will not exceed the capabilities of existing contingency measures over the planning period.
- Stakeholder service levels – ENL has assumed the current stakeholder expectations regarding security and service levels in section 1.4 and section 3, will not alter significantly throughout the planning period.
- Demand projections and Load Characteristics – Network loading and growth are assumed to occur in line with the demand forecasts in Section 4.3.
- Individual large loads and embedded generation – ENL has not included large individual loads or significant embedded generation other than that identified in section 4.3. It is assumed that developments that have not already been identified will not occur over the planning period.
- External regulations, legislation and technical industry standards and codes of practice – ENL has assumed the current environment will be unchanged over the planning period.



- Transpower's obligations and commitments - ENL has assumed the current arrangements will be unchanged over the planning period.
- Relative input costs and exchange rates and the cost of borrowing- ENL has assumed the current financial environment will be unchanged over the planning period. All financial projections are provided at current values.
- Resource availability- ENL has assumed the availability of resources will be at levels consistent with current levels over the planning period.
- Technological change- ENL has assumed that no significant technological change will occur over the planning period.

*(b) a description of changes proposed where the information is not based on the Distribution Business's existing business;*

No changes are proposed to the existing business of ENL, and thus all prospective information has been prepared consistent with the existing ENL business ownership and structure.

*(c) the basis on which significant assumptions have been prepared, including the principal sources of information from which they have been derived;*

All the significant assumptions identified in (a) above are based on the premise that ENL's is operating in a steady state with current conditions unlikely to vary significantly in future. The principal source of information from which future assumptions have been derived is historical data contained in the various systems described in section 1.6 of this AMP. These systems include the...

- Works Management System
- Network Control Systems
- Financials
- Network Modeling
- Asset Information Systems
- Gentrack Billing System
- Safety Management Systems

*(d) the factors that may lead to a material difference between the prospective information disclosed and the corresponding actual information recorded in future disclosures;*

Factors which may lead to a material difference between the AMP and future actual outcomes include any significant departure from the steady state trends or current conditions relating to the assumptions identified in (a) above.

*(e) the assumptions made in relation to these sources of uncertainty and the potential effect of the uncertainty on the prospective information.*

The assumptions made in relation to these sources of uncertainty are listed in (a) above. The potential effect of each on the prospective information contained in this AMP is:

<b>Source of Uncertainty</b>	<b>Potential Effect of Uncertainty</b>	<b>Potential Impact of the Uncertainty</b>
Ownership change	A change of ownership can potentially introduce new focus influencing primary inputs to the asset management plan.	Projected Expenditure may increase or decrease. Performance levels may decline or improve
Corporate Vision, Objectives and Targets	Changes will influence the primary inputs to the asset management plan.	Projected Expenditure may increase or decrease. Performance levels may decline or improve
Climate	A shift in weather patterns will influence the life cycle patterns of the assets and or design parameters of the network.	Projected Expenditure may increase or decrease. Performance levels may decline or improve. Load patterns may change.
Major disasters	Significant disasters may leave the network asset unviable requiring a new network to support a rebuild of the region.	Projected Expenditure likely to increase. Load patterns likely to be significantly altered.
Stakeholder service levels	Stakeholders could change their demands for service and willingness to pay.	Either higher or lower service targets will be established with an associated impact on expenditure.
Demand projections and Load Characteristics	Demand growth beyond expected levels will erode security levels. Negative growth will reduce income and leave an under-utilised asset.	Projected Expenditure may increase or decrease. Performance levels may decline or improve. Regional Development may be limited or new opportunities may emerge.
Individual large loads	Additional asset not covered by current	Projected Expenditure may increase or decrease.

and embedded generation	development plans will be required. Development timing for Transmission and subtransmission assets will alter.	
External regulations, legislation and technical industry standards and codes of practice	Current and forecast capital and maintenance programs will alter to accommodate changed requirements. Asset management systems replaced/alterd to accommodate changing information requirements.	Projected Expenditure may increase or decrease. Performance levels may decline or improve. Financial viability of the network business may improve or decline.
Transpower's obligations and commitments	Can alter forecast capital and maintenance programs, performance levels and revenue requirements.	Projected Expenditure may increase or decrease. Performance levels may decline or improve. Financial viability of the network business may improve or decline. Regional Development may be limited or new opportunities may emerge.
Relative input costs and exchange rates and the cost of borrowing	Alters capital and maintenance expenditure forecasts.	Projected Expenditure may increase or decrease.
Resource availability	Impacts on the ability to match resources to work programs.	Projected Expenditure may increase or Performance levels may decline. Viability of the network business may decline.
Technological Change	Typically improves accuracy of information and analysis systems. Or improves characteristics of asset behavior.	Performance levels would typically improve but may incur a corresponding increase in expenditure.

## A3. Disclosure Requirement 7(5)AM1

### ASSET MANAGEMENT PLAN REQUIREMENT: EXPENDITURE FORECASTS AND RECONCILIATION

ref		For initial forecast year ending (year 1) 2012/13											
		Actual for most recent Financial Year	Previous forecast for Current Financial Year	Forecast Year									
	for year ended	year -1	year 0	year 1	year 2	year 3	year 4	year 5	year 6	year 7	year 8	year 9	year 10
		2010/11	2011/12	2012/13	2013/14	2014/15	2015/16	2016/17	2017/18	2018/19	2019/20	2020/21	2021/22
3	<b>A) Ten Yearly Forecasts of Expenditure</b>												
4	Capital Expenditure: Customer Connection	78,238	90,000	90,000	90,000	90,000	90,000	90,000	90,000	90,000	90,000	90,000	90,000
5	Capital Expenditure: System Growth	645,459	1,028,000	978,000	1,228,000	978,000	1,213,000	1,318,000	1,278,000	1,353,000	1,118,000	1,058,000	528,000
6	Capital Expenditure: Asset Replacement and Renewal	3,816,303	3,999,000	4,290,000	4,215,000	4,445,000	4,275,000	4,445,000	4,429,000	4,375,000	4,070,000	4,175,000	4,210,000
7	Capital Expenditure: Reliability, Safety and Environment	124,270	110,000	220,000	130,000	155,000	90,000	415,000	440,000	65,000	90,000	65,000	80,000
8	Capital Expenditure: Asset Relocations	0	50,000	50,000	50,000	50,000	50,000	50,000	50,000	50,000	50,000	50,000	50,000
9	<b>Subtotal - Capital Expenditure on Asset Management</b>	<b>4,664,270</b>	<b>5,277,000</b>	<b>5,588,000</b>	<b>5,713,000</b>	<b>5,718,000</b>	<b>5,718,000</b>	<b>6,318,000</b>	<b>6,278,000</b>	<b>5,733,000</b>	<b>5,418,000</b>	<b>5,438,000</b>	<b>4,958,000</b>
10													
11	Operational Expenditure: Routine and Preventative Maintenance	1,019,000	1,536,940	1,566,900	1,566,900	1,566,900	1,566,900	1,566,900	1,566,900	1,566,900	1,566,900	1,566,900	1,566,900
12	Operational Expenditure: Refurbishment and Renewal Maintenance	143,567	230,000	280,000	280,000	280,000	280,000	280,000	280,000	280,000	280,000	280,000	280,000
13	Operational Expenditure: Fault and Emergency Maintenance	937,289	986,852	1,036,852	1,036,852	1,036,852	1,036,852	1,036,852	1,036,852	1,036,852	1,036,852	1,036,852	1,036,852
14	<b>Subtotal - Operational Expenditure on Asset Management</b>	<b>2,099,856</b>	<b>2,753,792</b>	<b>2,883,752</b>	<b>2,883,752</b>	<b>2,883,752</b>	<b>2,883,752</b>	<b>2,883,752</b>	<b>2,883,752</b>	<b>2,883,752</b>	<b>2,883,752</b>	<b>2,883,752</b>	<b>2,883,752</b>
15													
16	<b>Total Direct Expenditure on Distribution Network</b>	<b>6,764,126</b>	<b>7,710,213</b>	<b>8,471,752</b>	<b>8,596,752</b>	<b>8,601,752</b>	<b>8,601,752</b>	<b>9,201,752</b>	<b>9,161,752</b>	<b>8,616,752</b>	<b>8,301,752</b>	<b>8,321,752</b>	<b>7,841,752</b>
17													
18	<b>Overhead to Underground Conversion Expenditure</b>		150,000	150,000	150,000	150,000	150,000	350,000	350,000	150,000	150,000	150,000	150,000
19													
20													
21	<i>The Electricity Distribution Business is to provide the amount of Overhead to Underground Conversion Expenditure included in each of the above Expenditure Categories (explanatory notes can be provided in a separate note if necessary):</i>												
22													
23													
24													
25													
26													
27													
28													
29													
30													
31	<b>B) Variance between Actual Expenditure and Previous Year Forecasts</b>												
32													
33	Capital Expenditure: Customer Connection	78,238	90,000										
34	Capital Expenditure: System Growth	645,459	1,028,000										
35	Capital Expenditure: Asset Replacement and Renewal	3,816,303	4,007,000										
36	Capital Expenditure: Reliability, Safety and Environment	124,270	150,000										
37	Capital Expenditure: Asset Relocations	0	50,000										
38	<b>Subtotal - Capital Expenditure on Asset Management</b>	<b>4,664,270</b>	<b>5,325,000</b>										
39													
40	Operational Expenditure: Routine and Preventative Maintenance	1,019,000	1,496,940										
41	Operational Expenditure: Refurbishment and Renewal Maintenance	143,567	280,000										
42	Operational Expenditure: Fault and Emergency Maintenance	937,289	986,852										
43	<b>Subtotal - Operational Expenditure on Asset Management</b>	<b>2,099,856</b>	<b>2,753,792</b>										
44													
45	<b>Total Direct Expenditure on Distribution Network</b>	<b>6,764,126</b>	<b>8,078,792</b>										
46													
47													
48	<b>Explanation of Variance More than 10%</b>												
49	<i>Distribution Business must provide a detailed explanation for any line item variance of more than 10%</i>												
50													
51													
52													
53													
54													
55													
56													
57													
58													
59													
60													
61													

Refer sections 5.4.2 and 5.4.3 ENL AMP  
Overhead to Underground Conversion Expenditure has been budgeted in its entirety within the "Capital Expenditure Asset Replacement and Renewal" budget

*Explanatory Notes (can be provided in a separate note if necessary):*

Capital expenditure: Customer Connections: Less customer connections were required/requested from third parties than forecast, which resulted in under expenditure against budgeted contingency  
Capital Expenditure System Growth: The Mahla Sub transmission upgrade project was deferred due to unresolved resource consent issues.  
Capital Expenditure Reliability Safety and Environment: The actual cost of the completed projects was less than the budgeted costs provided for each project.  
Capital Expenditure asset relocations: There were no territorial authority requirements for asset relocations, and as a result there is no expenditure against the budgeted expenditure  
Operational Expenditure Routine and preventative Maintenance: Due to resourcing shortfalls, resources were deployed on Fault and Emergency work, and non operationally critical Routine and preventative Maintenance was deferred - the resources were deployed on higher priority fault work  
Operational Expenditure Refurbishment and Renewal Maintenance: Due to Resourcing shortfalls, resources were deployed on Fault and Emergency work, and non operationally critical Routine and preventative Maintenance was deferred - the resources were deployed on higher priority fault work

# A4. Director certification

## CERTIFICATE FOR ASSET MANAGEMENT PLANS



Pursuant to Requirement 11(2)

Eastland Network Limited, Asset Management Plan, for the period 2012 – 2022

We, Roger Neil Taylor and Michael John Glover  
Directors of Eastland Network Limited certify that, having made all reasonable enquiry, to the best of our knowledge, the attached asset Management plan of Eastland Network Limited prepared for the purposes of requirement 7 (1) of the Commerce Commission's Electricity Distribution (Information Disclosure) Requirements 2008 complies with those Requirements.

(Signature of 2 Directors)

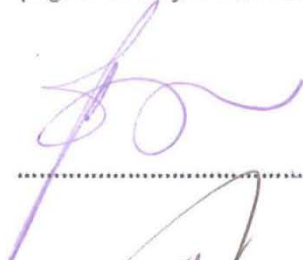
(Date)

  
.....  
  
.....

23/3/2012  
.....  
22/3/2012  
.....